

BIG WHITE®

SLV LIGHTING CATALOGUE 2024













WELL INFORMED

Scan QR code, select country and get our latest prices.
Visit us at **slv.com**

FAMILY HIGHLIGHTS

NUMINOS®	82
NEW TRIA®	122
MEDO®	148
LALU®	176
ONE®	186

INDOOR

 Recessed lights	202
 Ceiling lights	248
 Pendant lights	278
 Wall lights	320
 Wall and ceiling lights	390
 Table and floor lamps	434
 48V system	454
 Low-voltage cable system	480
 High-voltage track 1-phase	492
 High-voltage track 3-phase	524
 Profile solutions and LED strips	564

OUTDOOR

 Mobile lights and floor lights	594
 Spotlights	686
 Wall lights	704
 Ceiling lights	786
 Wall and ceiling lights	802
 Recessed lights	818
 Recessed floor lights	828

ACCESSORIES

 Lamps	858
 Accessory parts	866

NAVIGATION

Editorial and references	4
Index, Application	14
Index, Families	46
Index, Numerical	882
Index, Alphabetical	892

NEW NAVIGATION

CATEGORY OVERVIEW

Everything at a glance.

Find the right lights based on category.



FAMILY OVERVIEW

Discover all lights within a family for a well-rounded lighting design.

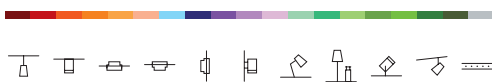

PRODUCT CATEGORIES

Know how long it lasts. The new icons and colours let you quickly and easily navigate to the respective product categories.



RECOMMENDATIONS

Fast and simple. Discover the right accessories and lamps for your selected products.

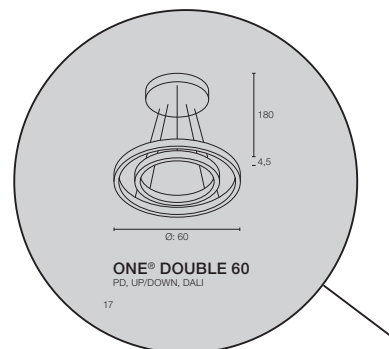

PLEASE NOTE

All measurements are given in **cm**.

CLEARLY EXPLAINED

In our new advice section, important information about lighting and our SLV products is explained clearly and concisely.

From planning tools and system representations to lighting knowledge, you'll learn everything in this BIG WHITE®. Take note of this when browsing our yellow advice pages, too.

DESIGN YOUR LED PROFILE

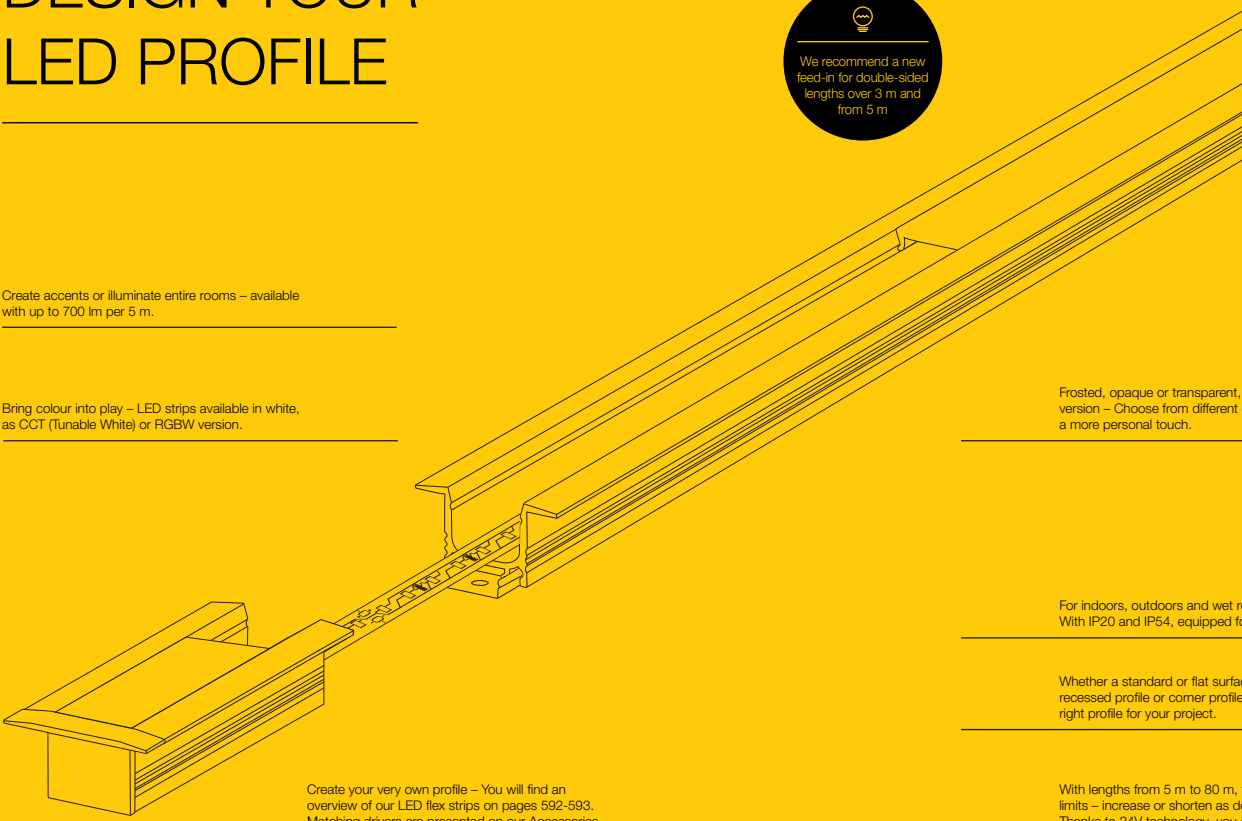

We recommend a new feed-in for double-sided lengths over 3 m and from 5 m

Create accents or illuminate entire rooms – available with up to 700 lm per 5 m.

Bring colour into play – LED strips available in white, as CCT (Tunable White) or RGBW version.

Frosted, opaque or transparent, in different versions – Choose from different options to give your project a more personal touch.

For indoors, outdoors and wet rooms – Choose from different options. With IP20 and IP54, equipped for your project.

Whether a standard or flat surface, recessed profile or corner profile: choose the right profile for your project.

Create your very own profile – You will find an overview of our LED flex strips on pages 592-593. Matching drivers are presented on our Accessories pages 866-881.

With lengths from 5 m to 80 m, the limits – increase or shorten as desired. Thanks to 24V technology, you can create long lengths with fewer feed-in points.

580



ALL PRODUCTS DIRECT ONLINE

At slv.com you will find the complete SLV range with all product details, descriptions, availability, and much more. Useful design files, 3D data, configurators and calculation tools such as FastCalc by DIAL are there to help you create your perfect lighting design.

VILLA WALDFEUCHT

A HOUSE FULL OF SLV LIGHTS

An Instagram channel that follows the adventures of a young couple building their own home.

Why the two decided on luminaires from SLV and what hurdles they had to overcome are reported daily on their channel.



WELL THOUGHT-OUT LIGHTING DESIGN

When planning the lighting, it was important for the two developers to establish a uniform style throughout the entire house. In addition, the lighting was to be permanently adapted to the later use – in other words, to ensure maximum flexibility.

Smart GU10 lamps were to be fitted in the luminaires. In addition, Susanna and Marc wanted a mixture of direct and indirect lighting that would also showcase works of art in the perfect light. For all these reasons, Susanna and Marc opted for tracks from SLV. Hardly any type of lighting offers more flexibility: with tracks, all luminaires can be exchanged, added or aligned differently.

What's more, when it comes to energy efficiency, power track is also impressive: with indirect lighting and smart control, electricity can be saved.



Susanna and Marc Mevißen have been sharing their progress with their followers since the groundbreaking ceremony in 2020 right up to the completion this year.

It is particularly noteworthy that, apart from the shell of the house, they did everything themselves. Despite the work on the house, which took place after the actual work of the two, they paid special attention to sustainable building, energy efficiency and sophisticated design. The result: after only 22 months, the house was already ready for occupancy.

„WE OPTED FOR SLV RIGHT FROM THE START AND THAT MADE THE LIGHTING DESIGN VERY EASY FOR US.“

Marc Mevißen, Architect

SERVICE AND QUALITY FROM SLV

There is a reason why Susanna and Marc chose luminaires from SLV: Marc Mevißen already knew SLV from his studies of architecture, when he became involved with light and shadow in the showroom.

When planning the lighting for their own dream house, the two influencers were particularly convinced by the design and the attractive price-performance ratio of the tracks. Added to this was the good support and fast service from SLV.





LIGHT AS A WORK OF ART

The dining room of Susanna and Marc's house has a large air space with a height of 5.65 m. Above the dining table, the couple wanted to create a kind of sculpture made of luminaires. As a basic construction, busbars were invisibly integrated into the acoustic ceiling in order to remain as flexible as possible. To come up with ideas, the team from SLV worked with the clients on site for inspiration and presented many new luminaires. „The PANTILO from SLV appealed to us best in terms of design in order to aesthetically fill the air space without glare,“ explains Susanna Mevißen. „We love this reflection in the luminaires very much and they round off our concept.“

The PANTILO pendant light impresses with its extraordinary appearance: the shade made from chrome-plated glass can be easily combined into a stylish group of luminaires by means of individual configuration. The seven PANTILO luminaires above the large dining table perfectly match the high wooden ceiling, the light-coloured walls, the grey floor and the black window frames in Susanna and Marc's house.

*„LUMINAIRES ARE NOT ONLY FUNCTIONAL –
THEY CAN ALSO GIVE A ROOM AN IDENTITY
AS A WORK OF ART.“*

Susanna Mevißen

INDIRECT LIGHT FOR A PLEASANT LIVING AMBIENCE

The house is not only equipped with lighting from SLV on the ceilings: spots are also integrated into the floor, where the colours can be individually adjusted. The two developers rely on indirect lighting and smart control for all lighting solutions in their dream house: depending on the light intensity in the room, some indirect luminaires illuminate the surroundings/room in the evening and immerse the house in the desired ambience. This means that hardly any light has to be actively switched on, which saves energy.



ECOLOGICAL BUILDING AND LIGHTING

Thanks to well thought-out insulation, a flat roof with a photovoltaic system and selected materials such as concrete, wood, glass and natural stone, the passive house of the two influencers Susanna and Marc meets the KfW40+ standard and is a plus-energy building. With the PV system, they produce significantly more energy than they consume. The house also has an energy storage system and a wallbox to use the electricity even more effectively.

This approach also fits in with our sustainability strategy: after all, we also try to focus on the use of secondary raw materials in the production of lighting solutions and consistently reduce packaging waste and transport emissions.

STRONG PROJECT. STRONG PARTNER.

Building owners: Susanna and Marc Mevißen

Location: Waldfeucht, North-Rhine Westphalia
Email: mevissen.haus@gmail.com

Lighting design: The building owners in cooperation with the SLV sales team

The lighting for the villa in Waldfeucht is not the only cooperation that our specialists have actively supported. Our partners can be found throughout Europe, with projects of all sizes. Want to know more? Scan me!

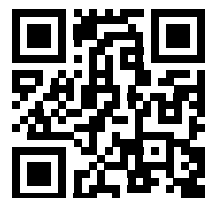

SLV LIGHTING KNOWLEDGE

LUMEN

The luminous flux (indicated in Lumen) describes how much light is emitted in all directions by a light source. It represents the overall brightness perceived by the human eye. The efficiency of a luminaire is often given in Lumen per Watt. The higher the luminous flux (in Lumen) per power consumed (in Watt), the more efficient the light source.

CRI

The colour rendering index is the impact of a light source on the colour of an object as perceived by the human eye compared to a natural source of light (e.g. sunlight). According to EN 12464-1, indoor spaces in which people spend or work for longer amounts of time should have a colour rendering index (CRI) of >80.

COLOUR TEMPERATURE

The colour temperature of a light source is indicated in Kelvin (K). The higher the colour temperature, the cooler and more stimulating the light (e.g. daylight = 5500K). The lower the Kelvin figure, the warmer and cosier the light. The colour temperature of a 2700K light bulb is now recommended as the perfect home lighting. The CCT switch allows the colour temperature of a luminaire to be adjusted.

DIM-TO-WARM (DTW)

The dim-to-warm feature lets you adjust the colour temperature and brightness of the light. When dimmed, the light changes from a bright, cool-white colour to a warm colour.

TUNEABLE WHITE (TW)

The Tuneable White function allows you to set the colour temperature of LED lights as desired. The light can be adjusted to suit different times of day and moods.

RGB RGB+W

An RGB-compatible luminaire covers the entire colour spectrum from red, green and blue with the white balance in the background. The white balance of the RGB+W is also optimised and represented in high quality.

PROTECTION CLASS

Protection classes indicate which safety measures a device has installed to prevent electric shocks. There are three protection classes which are represented by the symbols below.



IK

The IK protection class is a classification of building materials and surfaces that determines how resistant they are to mechanical impact such as blows, collisions or pressure.

IP

The abbreviation IP stands for Ingress Protection. The first digit in these standardised IP codes indicates the protection against solid objects, the second digit indicates protection against moisture.

HALF BEAM ANGLE

The half beam angle describes the light emission taking the composition of the luminaire, lamp and distance from an object into account. The smaller the half beam angle, the narrower the beam of light.

UGR

UGR (Unified Glare Rating) rates the glare of a luminaire to relieve the eye. The lower the UGR value, the more pleasant the light is to the eye. A UGR<19 is therefore recommended for workplaces.

SMART LIGHTING

Smart Lighting describes automated light management. With DALI, ZIGBEE, Casambi and BLUETOOTH, smart luminaires can be controlled via apps and other controls.

LALU®
1007519+1007522



LALU®
1007520+1007532



INDOOR RECESSED CEILING LIGHTS



NUMINOS®
can be found
on family pages
82–93

LED



NEW TRIA®
can be found
on family pages
122–147

LED



MEDO®
can be found
on family pages
168–171

LED



LED

UNIVERSAL
DOWNLIGHT | 205



LED

UNIVERSAL
DOWNLIGHT | 207



LED

UNIVERSAL
DOWNLIGHT | 208



LED

UNIVERSAL
DOWNLIGHT | 209



LED

KADUX | 213



LED

KADUX | 213



LED

KADUX | 213



SCKET

KADUX | 214



SCKET

KADUX | 214



SCKET

KADUX | 214



SCKET

KADUX | 215



SCKET

KADUX | 215



LED

MILANDOS 4 | 217



LED

MILANDOS 6 | 217



LED

MILANDOS 8 | 217



LED

HORN MINI | 218



SCKET

HORN | 219



SCKET

HORN | 219



SCKET

HORN | 219



SCKET

HORN | 220



SCKET

HORN | 220



SCKET

HORN | 220



SCKET

HORN-T | 221



LED

HORN MAGNA | 221



LED

SENER 12 | 223



LED

SENER 18 | 223



LED

SENER 24 | 223



LED

SENER 12 | 225



LED

SENER 18 | 225



LED

SENER 24 | 225



LED

VERLUX | 227



LED

VERLUX | 227



LED

DL 126 | 227



SCKET

PIKA | 228



SCKET

PIKA | 228



LED

OCULUS | 229



LED
OCCULDAS 14 | 230



LED
OCCULDAS 23 | 230



LED
CONTONE® | 231



LED
CONTONE® | 231



LED
H-LIGHT | 232



LED
KARPO 30 | 232



SCKET
PLASTRA | 233



SCKET
PLASTRA | 233



LED
DEKLED | 234



SCKET
VARU | 234



SCKET
DOLIX OUT | 235



SCKET
DOLIX OUT | 235



LED
KAMUELA ECO | 236



LED
KAMUELA ECO | 237



LED
KINI | 237



LED
AKALO D83 | 237



LED
FRAME BASIC SET | 238



LED
FRAME BASIC | 238



LED
FRAME BASIC | 238



LED
FRAME CURVE | 239



LED
FRAME CURVE | 239



LED
QUAD FRAME 9 | 240



LED
NOTAPO S | 241



LED
NOTAPO L | 241



LED
DOWNUNDER PUR 80 | 242



LED
DOWNUNDER PUR 150 | 242



LED
MOBALA | 243



LED
WORO | 243



LED
LED PANEL | 243



LED
PATTA-I | 244



LED
PATTA-I | 244



LED
PATTA-I | 245



LED
PATTA-I | 245



LED
PATTA-F | 246



LED
PATTA-F | 247

OUTDOOR RECESSED WALL LIGHTS



OUTDOOR RECESSED FLOOR LIGHTS

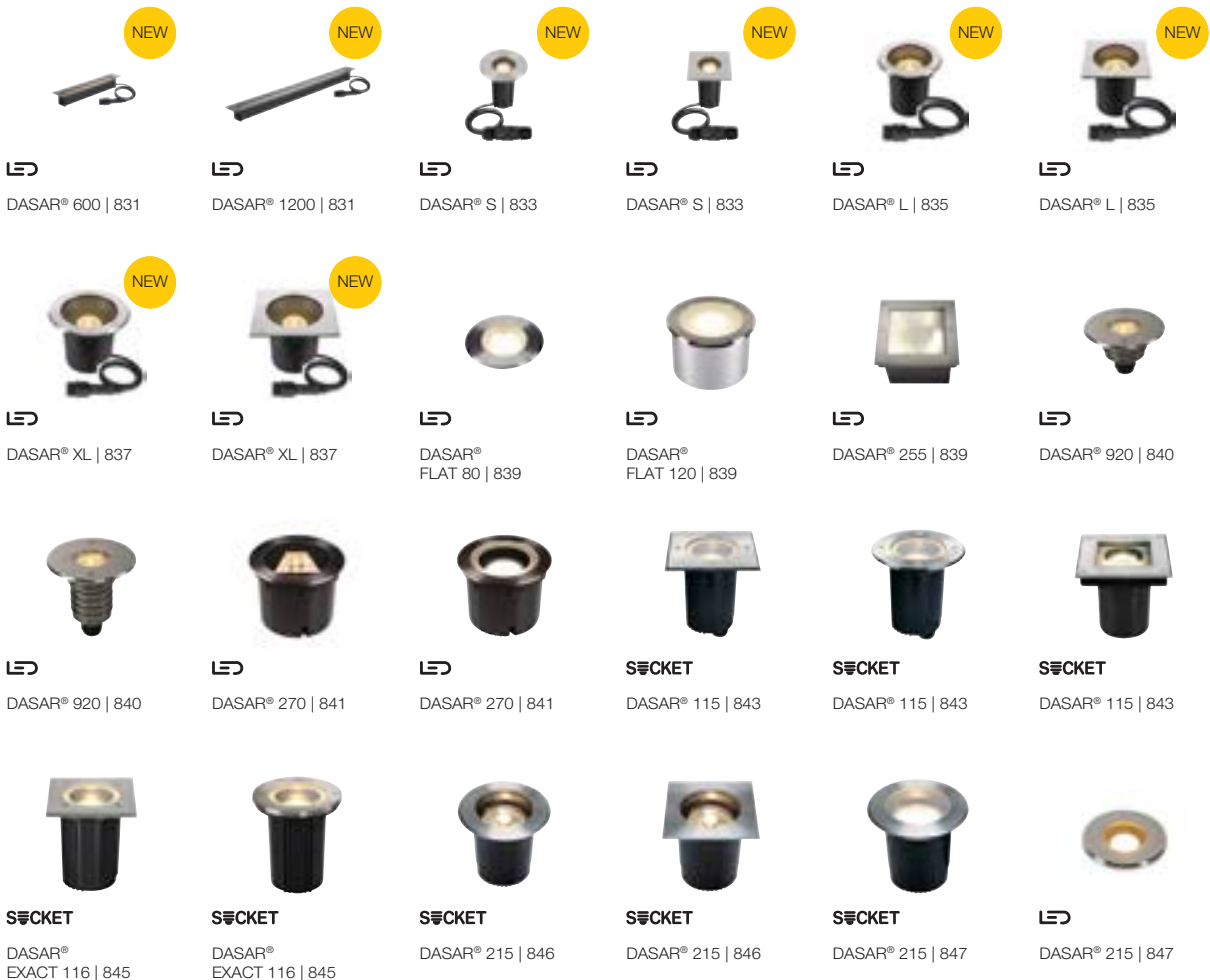



LED
TRAIL-LITE® 60 | 848



LED
POWER TRAIL-LITE® | 849



LED
POWER TRAIL-LITE® | 849



LED
GIMBLE OUT | 849



LED
SMALL PLOT | 851



LED
SMALL PLOT | 851



SMALL PLOT | 851



SMALL PLOT | 851



LED
BIG PLOT | 853



LED
BIG PLOT | 853



BIG PLOT | 853



BIG PLOT | 853



LED
ROCCI | 854



LED
ROCCI | 854



LED
ROCCI 200 | 855



LED
ROCCI 200 | 855



SOCKET
SOLASTO | 857



SOCKET
SOLASTO | 857





NUMINOS®
can be found
on family pages
102–105

LED



MEDO®
can be found
on family pages
164–165

LED



SCKET
VARYT | 251



LED
Q-LINE® | 253



LED
Q-LINE® | 253



SCKET
TRILEDO | 255



SCKET
TRILEDO | 255



SCKET
TRILEDO | 255



LED
TRILEDO | 257



LED
TRILEDO | 257



LED
TRILEDO | 257



LED
OCULUS | 258



SCKET
ENOLA B | 259



LED
ENOLA C | 259



SCKET
ASTINA | 261



SCKET
NAGY 75 | 261



LED
ANELA | 261



LED
OCCULDAS 13 | 262



LED
OCCULDAS 23 | 262



SCKET
ALTRA DICE | 263



SCKET
ALTRA DICE | 263



SCKET
KARDAMOD | 265



SCKET
KARDAMOD | 265



SCKET
FENDA | 266



LED
FENDA | 267



LED
FENDA | 267



LED
FENDA | 267



SCKET
TENORA | 268



SCKET
SOPRANA | 269



SCKET
PLASTRA | 270



LED
PLASTRA | 271



SCKET
PLASTRA 105 | 271



SCKET
PLASTRA 104 | 271



LED
FERA 25 | 272



LED
FERA 25 | 272



LED
MARONA | 273



LED
PANEL 60 | 274



LED
PANEL | 275



LED
PANEL 60 | 275



LED
PANEL | 275



OUTDOOR | CEILING LIGHTS

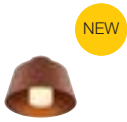

SCKET
PHOTONI | 789



LED
S-CUBE | 791



LED
ESKINA FRAME | 791



LED
ENOLA OCULUS | 792



LED
ENOLA ROUND S | 793



LED
ENOLA ROUND M | 793



LED
ENOLA ROUND L | 793



LED
ENOLA SQUARE S | 795



LED
ENOLA SQUARE M | 795



LED
ENOLA SQUARE L | 795



LED
BIG THEO | 797



SCKET
BIG THEO | 797



LED
OVALISK | 797



SCKET
PHOTONIA | 799



SCKET
MOLAT | 799



SCKET
SITRA | 801



SCKET
ROX | 801



SCKET
ROX | 801



INDOOR PENDANT LIGHTS



MINIMOS®
can be found
on family pages
106–109

LED



MEDO®
can be found
on family pages
166–167

LED



LALU®
can be found
on family pages
176–185

NEW

LED



ONE®
can be found
on family pages
186–191

LED



NEW

SCKET
PANTILO
ROPE 19 | 279



NEW

SCKET
PANTILO
ROPE 20 | 279



NEW

SCKET
PANTILO
ROPE 27 | 279



NEW

SCKET
PANTILO OVAL | 281



NEW

SCKET
PANTILO 20 | 281



NEW

SCKET
PANTILO 28 | 281



SCKET
PANTILO
CONVEX 29 | 283



SCKET
PANTILO
CONVEX 40 | 283



SCKET
ASTO TUBE | 285



SCKET
ASTO TUBE | 285



SCKET
ASTO TUBE | 285



SCKET
ASTO TUBE | 285



NEW

LED
WORKLIGHT
PRO 120 | 287



NEW

LED
WORKLIGHT
PRO 150 | 287



NEW

LED
WORKLIGHT | 288



LED
I-PENDANT PRO | 289



LED
PANEL 60 | 289



LED
NOYA | 290



LED
GLENOS® | 291



LED
GLENOS® | 291



LED
Q-LINE® | 293



LED
Q-LINE® | 293



LED
Q-LINE® | 293



LED
OCULUS | 294



SCKET
FITU | 295



SCKET
FENDA | 296



FENDA | 296



FENDA | 296



FENDA | 297



FENDA | 297



FENDA | 297



LED
HELIA
AMBIENT 35 | 300



LED
HELIA
AMBIENT 35 | 300



LED
HELIA 30 | 301



LED
HELIA 30 | 301



LED
HELIA 40 | 303



LED
HELIA 40 | 303



SCKET
ASTINA | 305



SCKET
ENOLA B | 305



SCKET
ENOLA | 305



LED
ANELA | 306



SCKET
LISENNE | 306



SCKET
TONGA® | 307



SCKET
QUADRASS | 307



SCKET
PARA CONE GL | 309



SCKET
PARA CONE 20 | 309



SCKET
PARA CONE 30 | 309



SCKET
PHELIA 10 | 310



SCKET
PHELIA 20 | 311



SCKET
PHELIA 25 | 311



SCKET
PHELIA 30 | 311



SCKET
FORCHINI 50 | 312



SCKET
FORCHINI 70 | 312



SCKET
FORCHINI M 40 | 313



SCKET
FORCHINI M 50 | 313



SCKET
LIGHT EYE® 90 | 314



SCKET
LIGHT EYE® 150 | 314



SCKET
SUN / BIG SUN | 315



SCKET
ROTOBALL 25 | 317



SCKET
ROTOBALL 40 | 317



SCKET
ROTOBALL 50 | 317



SCKET
PARA DOME | 318



PARA DOME | 318



PARA DOME | 318



SCKET
PARA 380 | 319

INDOOR WALL LIGHTS



LED
LYGANT | 325



LED
LYGANT | 325



SCKET
VARYT | 327



LED
SEDO 7 | 329



LED
SEDO 14 | 329



LED
SEDO 21 | 329



LED
TRUKKO | 330



LED
TRUKKO | 330



LED
TRUKKO | 331



LED
TRUKKO 80 | 331

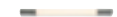

LED
TRUKKO 60 | 332



LED
TRUKKO 90 | 332



LED
MARYLIN 40 | 333



LED
WL 149 | 334



SCKET
WL 149 | 334



SCKET
WL 106 | 335



SCKET
WL 106 | 335



SCKET
MIBO UP/DOWN | 337



LED
MAGANDA | 337



LED
DORISA 30 | 339



LED
DORISA 50 | 339



LED
GLENOS® 60 | 339



LED
L-LINE 60 | 341



LED
L-LINE 120 | 341



LED
Q-LINE® | 341



SCKET
PANTILO ROPE | 345



SCKET
ASTO TUBE | 347



SCKET
ASTO TUBE | 347



LED
MANA BASE | 349



LED
MANA BASE | 349



LED
MANA 40 | 319



LED
MANA 60 | 349



LED
MANA | 351



LED
MANA | 351



LED
MANA | 351



LED
MANA | 353



LED
MANA | 353



LED
MANA | 353



LED
MANA | 353



LED
OCULUS | 355



LED
OCULUS
UP/DOWN | 355



SCKET
PLASTRA | 356



SCKET
PLASTRA | 356



SCKET
PLASTRA | 357



SCKET
PLASTRA | 357



SCKET
PLASTRA | 359



LED
PLASTRA | 359



LED
PLASTRA | 359



SCKET
PLASTRA | 360



SCKET
PLASTRA 101 | 361



SCKET
PLASTRA | 361



SCKET
PLASTRA 104 | 361



LED
LOGS IN | 362



LED
LOGS IN | 362



LED
LOGS IN L | 363



LED
LOGS IN L | 363



LED
QUAD FRAME 14 | 364



LED
QUAD FRAME 19 | 364



LED
SHELL 15 | 365



LED
SHELL 30 | 365



LED
ASSO 300 | 366



LED
ASSO 300 | 367



SCKET
OSSA 180 | 367



SCKET
OSSA 300 | 367



LED
CARISO | 368



LED
CARISO | 368



LED
CHROMBO | 369



LED
DIRETO 60 | 370



LED
DIRETO 90 | 370



LED
ARLINA 60 | 371



LED
ARLINA 130 | 371



SCKET
ANDREAS | 373



SCKET
DENA 30 | 373



SCKET
BASKET | 373



SCKET
QUADRASS | 375



LED
QUADRASS
SPOT | 375



SCKET
LISENNE | 375



SCKET
FITU | 376



SCKET
FITU CUBE | 376



SCKET
THEO UP/DOWN | 377



SCKET
SOLID CUBE | 377



ENOLA B | 379



ENOLA B | 379



ASTINA
UP/DOWN | 379

INDOOR WALL LIGHTS



SCKET

FENDA | 380



FENDA | 380



LED

KENKUA SPOT | 381



LED

COUPA FLEX | 381



LED

KARPO MAGN | 382



LED

KARPO GOOSE | 382



LED

KARPO 30 | 383



LED

KARPO | 383



LED

SOMNILA SPOT | 384



LED

SOMNILA SPOT | 385



LED

SOMNILA FLEX | 385



LED

SOMNILA FLEX | 385



SCKET

DIO FLEX PLATE | 387



LED

DIO FLEX PLATE | 387



LED

DIO FLEX PLATE | 387



SCKET

PHELIA | 388



LED

MERADO FLOOD | 388



SCKET

DISPLAY ADL 50 | 389



OUTDOOR WALL LIGHTS



SCKET
PHOTONI | 709

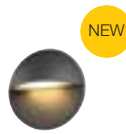

LED
LID II | 711

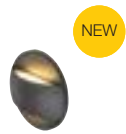

LED
LID II | 711



LED
LID I | 713



LED
LID I | 713



LED
I-RING | 714



LED
OVAL 14 | 715



LED
OVAL 18 | 715



LED
CONCRETO M | 717



LED
CONCRETO L | 717



LED
VANO WING | 719



LED
VANO WING | 719



LED
MANA BASE | 720



RUSTY®
MANA | 720



RUSTY®
MANA | 720



LED
MANA OUT | 721



LED
MANA OUT | 721



LED
ENOLA OCULUS | 723



LED
ENOLA
OCULUS | 723



LED
ENOLA
OCULUS S | 725



LED
ENOLA
OCULUS M | 725



LED
ENOLA
ROUND L | 725



LED
ENOLA ROUND S
UP/DOWN | 727



LED
ENOLA ROUND M
UP/DOWN | 727



LED
ENOLA ROUND L
UP/DOWN | 727



LED
ENOLA
SQUARE S | 729



LED
ENOLA
SQUARE M | 729



LED
ENOLA
SQUARE L | 729



LED
ENOLA SQUARE S
UP/DOWN | 730



LED
ENOLA SQUARE M
UP/DOWN | 730



LED
ENOLA SQUARE L
UP/DOWN | 730



SCKET
THEO UP/DOWN | 735



LED
BIG THEO BEAM UP/
FLOOD DOWN | 735



SCKET
BIG THEO
UP/DOWN | 735



LED
BIG THEO FLOOD
UP/DOWN | 736



SCKET
THEO | 736



SCKET
BIG THEO | 737



LED
BIG THEO | 737



LED
SITRA S | 739



LED
SITRA S | 739



LED
SITRA M | 741



LED
SITRA L | 741

OUTDOOR WALL LIGHTS

NEW



SCKET
SITRA CUBE | 741



SCKET
GRAFIT | 742



SCKET
GRAFIT | 742



SCKET
GRAFIT | 743



SCKET
GRAFIT | 743



LED
QUADRULO | 744



SCKET
QUADRULO
SENSOR | 745



SCKET
QUADRULO | 745



SCKET
MERIDIAN | 746



SCKET
MERIDIAN BOX | 746



SCKET
MERIDIAN BOX
SENSOR | 747



SCKET
MERIDIAN BOX | 747



LED
ESKINA FRAME | 749



LED
ESKINA FRAME | 749



LED
ESKINA FRAME | 749



LED
BOOKAT | 751



LED
BIG QUAD | 752



LED
QUAD | 752



LED
QUAD
UP/DOWN 15 | 753



LED
BIG QUAD
UP/DOWN | 755



LED
BIG QUAD | 755



LED
RUSTY®
UP/DOWN | 756



LED
RUSTY®
UP/DOWN | 756



LED
OVALISK
SENSOR | 757



LED
OVALISK | 757



LED
PEMA® | 758



LED
PEMA® | 759



LED
PEMA® | 759



SCKET
PEMA® | 759



LED
FLATT SENSOR | 760



LED
FLATT | 760



SCKET
ASTINA | 761



SCKET
ASTINA STEEL | 761



LED
ANGOLUX
SENSOR | 762



LED
ANGOLUX | 762



LED
VILUA S | 763



LED
VILUA L | 763



LED
VILUA | 763



SCKET
MYRA
UP/DOWN | 764



LED
SITRA
UP/DOWN | 765



SCKET
SITRA
UP/DOWN | 765



SCKET
ROX | 767



SCKET
ROX UP/DOWN | 767



LED
DELWA | 767



LED
SLOTS | 768



SCKET
WALLYX | 768



LED
DOWNUNDER
OUT | 769



LED
DOWNUNDER
OUT | 769



LED
ABRIDOR
SENSOR | 770



LED
ABRIDOR | 770



LED
ORDI SENSOR | 771



LED
ORDI | 771



SCKET
BOX-L | 773



LED
BOX-L | 773



SCKET
BOX UP/DOWN | 773



LED
LOGS | 775



LED
OUT-BEAM UP /
FLOOD DOWN | 775



LED
L-LINE OUT | 775



SCKET
PHOTONIA | 777



SCKET
MOLAT | 777



SCKET
GLOO PURE | 777



SCKET
F-POL | 778



SCKET
SQUARE | 779



SCKET
KERAS ELT | 779



SCKET
SITRA | 779



LED
RASCALI | 780



LED
IPERI | 780



SCKET
QUADRASYL | 781



SCKET
SQUARE TURN | 781



LED
TODAY PRO | 783



LED
ESKINA D | 783



SCKET
MYRA DISPLAY | 783



LED
LED SPOT | 785



SCKET
NAUTILUS | 785



SCKET
MYRA | 785



NUMINOS®
can be found
on family pages
98-101

LED



MEDO®
can be found
on family pages
148-163

LED



ONE®
can be found
on family pages
192-193

LED



SCKET
PANTILO
ROPE 19 | 393



SCKET
PANTILO
ROPE 27 | 393



LED
CYFT | 395



SCKET
ASTO TUBE | 395



SCKET
ASTO TUBE | 397



SCKET
ASTO TUBE | 397



SCKET
ASTO TUBE | 399



SCKET
ASTO TUBE | 397



LED
OCULUS | 399



LED
KARPO 30 | 399



LED
NOBLO® | 401



LED
NOBLO® | 401



LED
NOBLO® | 401



LED
KALU | 403



LED
KALU | 403



LED
KALU | 403



LED
KALU | 403



SCKET
KALU | 405



SCKET
KALU | 405



SCKET
KALU | 405



SCKET
KALU | 405



SCKET
ENOLA B | 407



SCKET
ENOLA B | 407



SCKET
ENOLA B | 407



SCKET
ALTRA DICE | 408



SCKET
SPOT 79 | 409



SCKET
INDA | 409



SCKET
PURI | 411



SCKET
PURI | 411



SCKET
PURI | 411



SCKET
PURI | 411



SCKET
AVO | 413



SCKET
AVO | 413



SCKET
AVO | 413



SCKET
AVO | 413



SCKET
AVO | 415



SCKET
ASTO | 415



SCKET
ASTO | 415



SCKET
ASTO | 415



LED
SENSER
12, 18, 24 | 417



LED
SENSER
12, 18, 24 | 419



LED
SIMA | 420



LED
SIMA | 421



LED
LIPSY®
30, 40, 50 | 423



LED
LIPSY®
30, 40, 50 | 425-426



SCKET
MELAN | 427



SCKET
GLASSA | 427



LED
BATTEN 60 | 429



LED
BATTEN 120 | 429



LED
LONG GRILL | 430



LED
SIGHT 60 | 431



LED
SIGHT 115 | 431



LED
BENA 120 | 433



LED
BENA 150 | 433

OUTDOOR WALL AND CEILING LIGHTS



LED
R-CUBE | 805



LED
S-CUBE | 805



SCKET
S-TUBE | 805



LED
ESKINA SPOT/
SENSOR | 807



SCKET
SITRA 360 | 808



SCKET
THEO BRACKET | 808



LED
HELIA | 809



LED
HELIA | 809



SCKET
MYRA | 811



LED
OUT-BEAM
FRAME | 811



LED
QUADRULO | 811



LED
AINOS | 812-813



LED
AINOS | 813



LED
RUBA | 814



SCKET
BULAN | 815



SCKET
BULAN GRID | 815



LED
TERANG 200 | 817



LED
IMPERVA | 817

VINOLINA TWO
1007696





INDOOR TABLE AND FLOOR LAMPS



NEW

ONE®
can be found
on family pages
196–197

LED



NEW

LED

VINOLINA ONE | 437



NEW

LED

VINOLINA | 437



NEW

LED

VINOLINA TWO | 439



NEW

LED

TAHA | 441



NEW

SCKET

TINY SUN | 443



NEW

SCKET

LITTLE SUN | 443



NEW

SCKET

VARYT | 443



NEW

LED

WORKLIGHT
PRO | 444



NEW

LED

WORKLIGHT
PRO | 444



LED

WORKLIGHT | 445



LED

WORKLIGHT | 445



SCKET

FENDA | 447



SCKET

FENDA | 447



SCKET

FENDA | 447



SCKET

FENDA | 448



SCKET

FENDA BOW
BASIS | 448



FENDA | 448



FENDA | 449



FENDA | 449



FENDA | 449



LED

KARPO | 452



LED

KARPO | 452



SCKET

PHELIA | 453



LED

TONILA | 453



LED

MAGANDA | 453

MOBILE LIGHTS AND OUTDOOR FLOOR LAMPS



NEW

LED
VINOLINA ONE | 597



NEW

LED
VINOLINA | 597



NEW

LED
VINOLINA TWO | 599



LED
TONILA | 601



NEW

LED
TAHA | 601



NEW

SCKET
S-TUBE 32/75 | 603



NEW

SCKET
PHOTONI 45/75 | 605



NEW

LED
S-CUBE 35/75 | 607



NEW

LED
R-CUBE 35/70 | 609



NEW

LED
LID I 75 | 611



NEW

LED
LID I 45 | 611



NEW

LED
I-RING | 613



NEW

LED
M-POL S | 614



NEW

LED
M-POL S | 615



LED
M-POL S | 616



LED
M-POL S | 617



LED
M-POL S | 618



LED
M-POL M | 619



LED
M-POL M | 620



LED
M-POL M | 621



M-POL 30/60/90 | 623



SCKET
CONCRETO | 627



SCKET
CONCRETO | 627



LED
ESKINA
FRAME 45/75 | 629



LED
ESKINA
FRAME 75 | 629



LED
ESKINA FRAME
125/175 | 630



LED
ESKINA 30/80 | 631



LED
LOGS 40/70 | 633



SCKET
GRAFIT 30/60/90 | 635



SCKET
GRAFIT 30/60/90 | 637



LED
QUADRULO | 639



LED
RUSTY®
SLOT 50/80 | 640



SCKET
RUSTY®
SLOT 50/80 | 641



SCKET
RUSTY®
PATHLIGHT | 642



LED
RUSTY® 40/70 | 643



SCKET
RUSTY® 40/70 | 643



SCKET
RUSTY®
CONE 24 | 645



SCKET
RUSTY®
CONE 40/70 | 645



SCKET
RUSTY® 40/70 | 646



SCKET
ARROCK
GRANITE 40/70 | 647



SCKET
ARROCK
ARC | 648



LED
ARROCK
STONE 50/75 | 649



SCKET
ARROCK SLOT | 649



LED
L-LINE OUT 30 | 650



LED
L-LINE OUT 60 | 651



LED
L-LINE
OUT 50/80 | 651



SCKET
THEO
PATHLIGHT | 652



LED
OVALISK 75/100 | 653



SCKET
GLOO PURE
27/44/70 | 655



SCKET
ROTOBALL
25/40/50 | 657



SCKET
PHOTONIA | 659



SCKET
PHOTONIA | 659



SCKET
OTOS GLAS | 659



SCKET
CUBIX | 660



SCKET
CONE | 660



SCKET
MOLAT | 661



SCKET
MOLAT | 661



SCKET
LISENNE 40/70 | 662



SCKET
ADEGAN
MANILA | 663



SCKET
ADEGAN | 663



SCKET
ALPA MUSHROOM
45/75 | 665



SCKET
ALPA CONE 100 | 665



LED
APONI 90/120 | 666



LED
TRUST 30/60 | 667



SCKET
BIG NAILS 50/80 | 668



SCKET
ROX ACRYL
30/60/90 | 669



SCKET
VAP SLIM
30/60/90 | 671



SCKET
C-POL | 672



SCKET
F-POL | 672



SCKET
SQUARE
POLE 30/60/90 | 673



LED
SLOTS 45/65 | 675



LED
H-POL 30/60 | 676



LED
H-POL TWIN
30/60 | 677



LED
SLOTBOX 40/70 | 678



LED
FLATT 65/100 | 679



LED
ABRIDOR 60/100 | 681



LED
IPERI 50 | 681



SCKET
QUADRASYL 75 | 682



LED
QUAD POLE | 683



LED
BOOKAT | 683



LED
RASCALI 45/65 | 684



SCKET
MYRA SPOT | 685



SCKET
SITRA 360 | 685

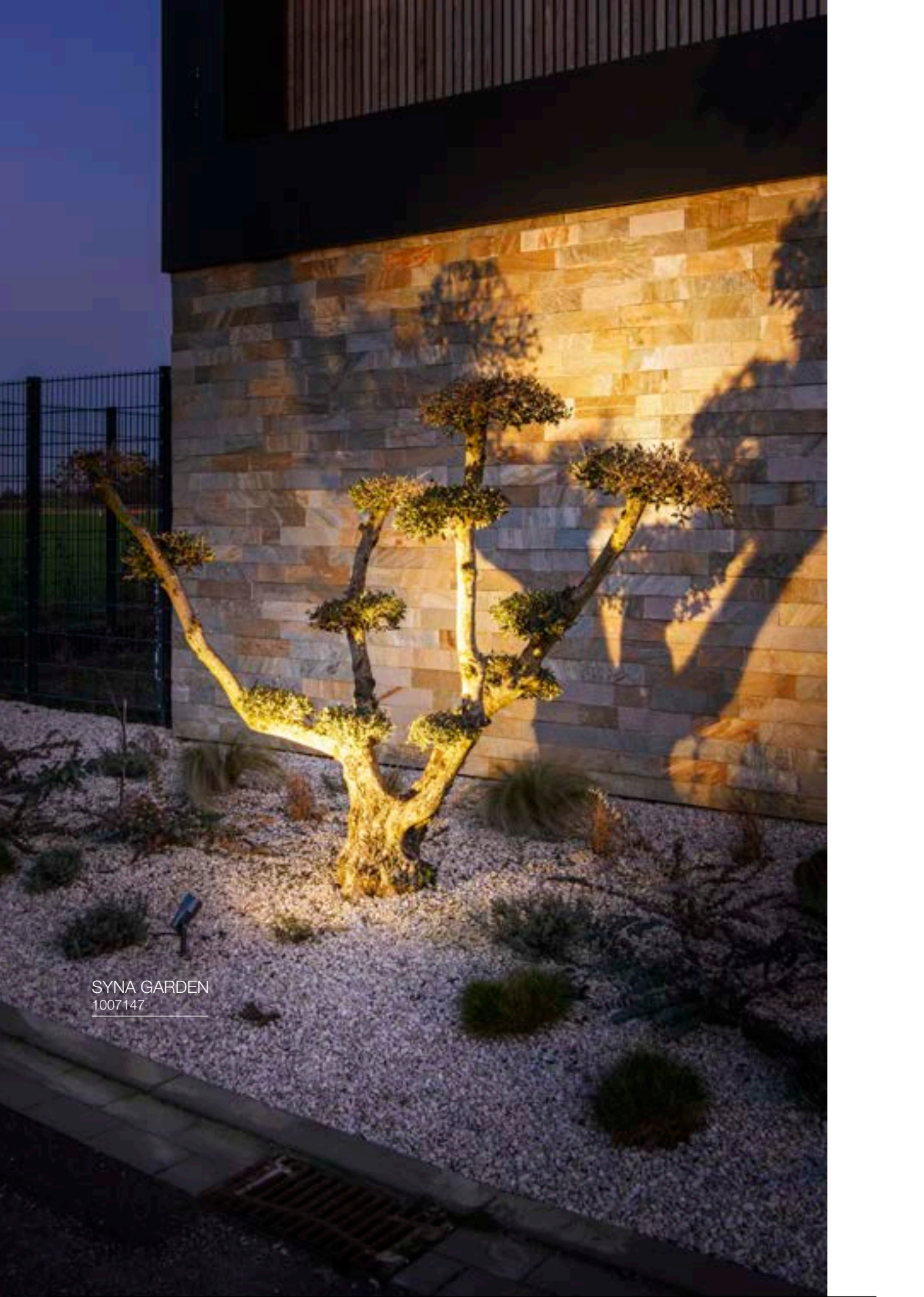

SYNA GARDEN
1007147



OUTDOOR SPOTLIGHTS



LED
SYNA PLANT | 689



LED
SYNA GARDEN | 689



LED
SYNA | 689



LED
FLOODI S | 691



LED
FLOODI M | 691



LED
FLOODI L | 691



LED
GALEN 60 | 692



LED
GALEN 120 | 692



LED
FLAC BEAM® | 693



SCKET
SAMRINA | 693



SCKET
NAUTILUS 10 | 694



SCKET
BIG NAUTILUS | 694



SCKET
NAUTILUS 10 | 695



LED
NAUTILUS 10 | 696



SCKET
NAUTILUS | 697



SCKET
NAUTILUS 10
SPOT | 697



LED
NAUTILUS 10
SPOT LED | 697



LED
DASAR®
PROJECTOR | 698



LED
DASAR® 920 | 698



LED
HELIA SPOT S | 699



LED
HELIA SPOT L | 699



SCKET
THEO BRACKET | 701



LED
LED SPIKE | 701



SCKET
SITRA 360 SPIKE | 703



SCKET
SITRA 360 SPIKE | 703

IN-LINE 44
1006621

NUMINOS® XS
1006762

NUMINOS® XS
1006654

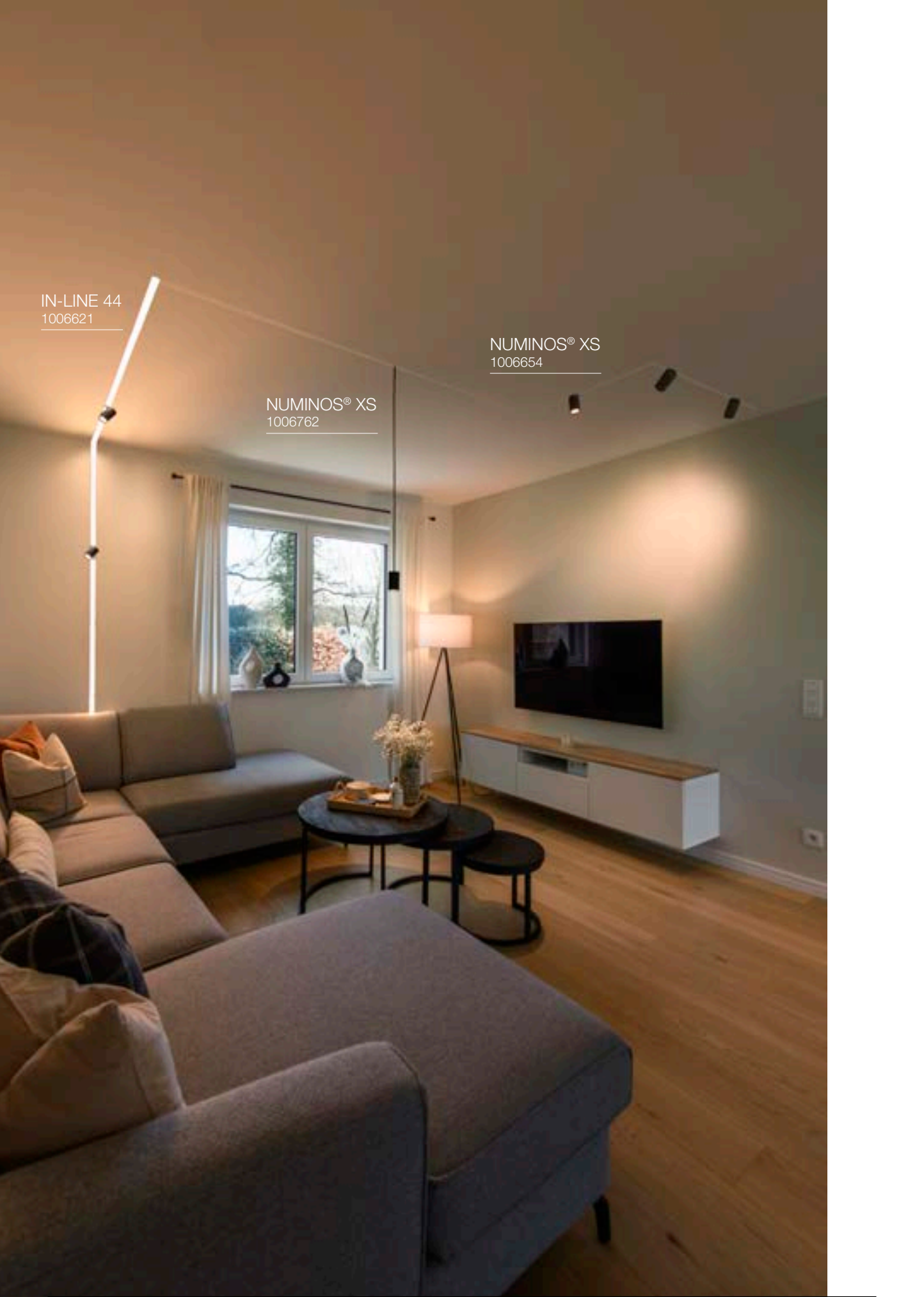













INDOOR 48V SYSTEMS

 <p>NEW</p>	 <p>NEW</p>	 <p>NEW</p>	 <p>NEW</p>	 <p>NEW</p>	 <p>NEW</p>
<p>LED NUMINOS® XS 468</p>	<p>LED NUMINOS® S 468</p>	<p>LED NUMINOS® XS 470</p>	<p>LED NUMINOS® S 470</p>	<p>LED IN-LINE 22 473</p>	<p>LED IN-LINE 22 475</p>
 <p>NEW</p>	 <p>NEW</p>	 <p>NEW</p>	 <p>NEW</p>		
<p>LED IN-LINE 44 475</p>	<p>LED IN-LINE 44 475</p>	<p>LED IN-LINE 24 477</p>	<p>LED IN-LINE 46 477</p>		

INDOOR LOW-VOLTAGE SYSTEMS































					
<p>SOCKET ASMARA 486</p>	<p>SOCKET TELESKOP 486</p>	<p>SOCKET COSMIC 487</p>	<p>SOCKET SYROS 489</p>	<p>SOCKET SALUNA 489</p>	<p>LED DURNO 489</p>
					
<p>LED PLYTTA 490</p>	<p>LED NOBLO® SPOT 491</p>	<p>LED COMET LED 491</p>	<p>SOCKET COMET 491</p>		

NOBLO® SPOT
1007352





INDOOR 1-PHASE SYSTEMS

					
LED NOBLO® SPOT 501	LED NOBLO® SPOT 501	LED NOBLO® SPOT 503	LED NOBLO® SPOT 503	SCKET ASTO TUBE 505	SCKET PANTILO ROPE 19 505
					
LED HELIA 50 TRACK 507	LED PANEL TRACK 507	LED PANEL TRACK 507	SCKET PARA CONE GL 508	SCKET PARA CONE GL 508	SCKET PARA CONE 14 509
					
SCKET PARA CONE 14 509	SCKET TONGA® 511	SCKET LIGHT EYE® 90 511	SCKET LIGHT EYE® 150 511	SCKET FORCHINI M 40 TRACK 512	SCKET PURI TRACK 513
					
SCKET PURI TRACK 513	SCKET PURI TRACK 515	SCKET AVO TRACK 515	LED ENOLA C TRACK 516	LED ENOLA C TRACK 517	SCKET ENOLA B TRACK 517
					
SCKET ENOLA B 517	SCKET BIMA 519	SCKET BIMA 519	LED KALU TRACK 520	SCKET KALU TRACK 520	SCKET EURO SPOT TRACK 521
					
SCKET ALTRA DICE TRACK 521					

TS V
1007655





INDOOR 3-PHASE SYSTEMS



NUMINOS®
can be found
on family pages
110-115

LED



ONE®
can be found
on family pages
194-195

LED



TS V | 543



TS V | 543



NOBLO® SPOT | 545



NOBLO® SPOT | 545



NOBLO® SPOT | 547



NOBLO® SPOT | 547



SCKET
PANTILO
ROPE 19 | 549



LED
SIGHT TRACK | 550



LED
SIGHT TRACK | 550



LED
SIGHT MOVE | 551



LED
SIGHT MOVE | 551



SCKET
PARA CONE GL | 552



SCKET
PARA CONE GL | 552



SCKET
PARA CONE 14 | 553



SCKET
PARA CONE 14 | 553



SCKET
FORCHINI M 40
TRACK | 554



LED
EURO CUBE | 555



SCKET
EURO SPOT
TRACK | 555



SCKET
EURO SPOT
TRACK | 555



SCKET
ALTRA DICE
TRACK | 556



SCKET
PURI TRACK | 557



SCKET
PURI TRACK
GLASS | 557



LED
KALU TRACK
LED | 558



SCKET
KALU TRACK | 558



SCKET
BIMA | 559



SCKET
BIMA | 559



LED
HELIA 50 TRACK | 561



LED
ENOLA C TRACK | 561



SCKET
AVO TRACK | 561

GRAZIA PRO
FLEXSTRIP
1007352

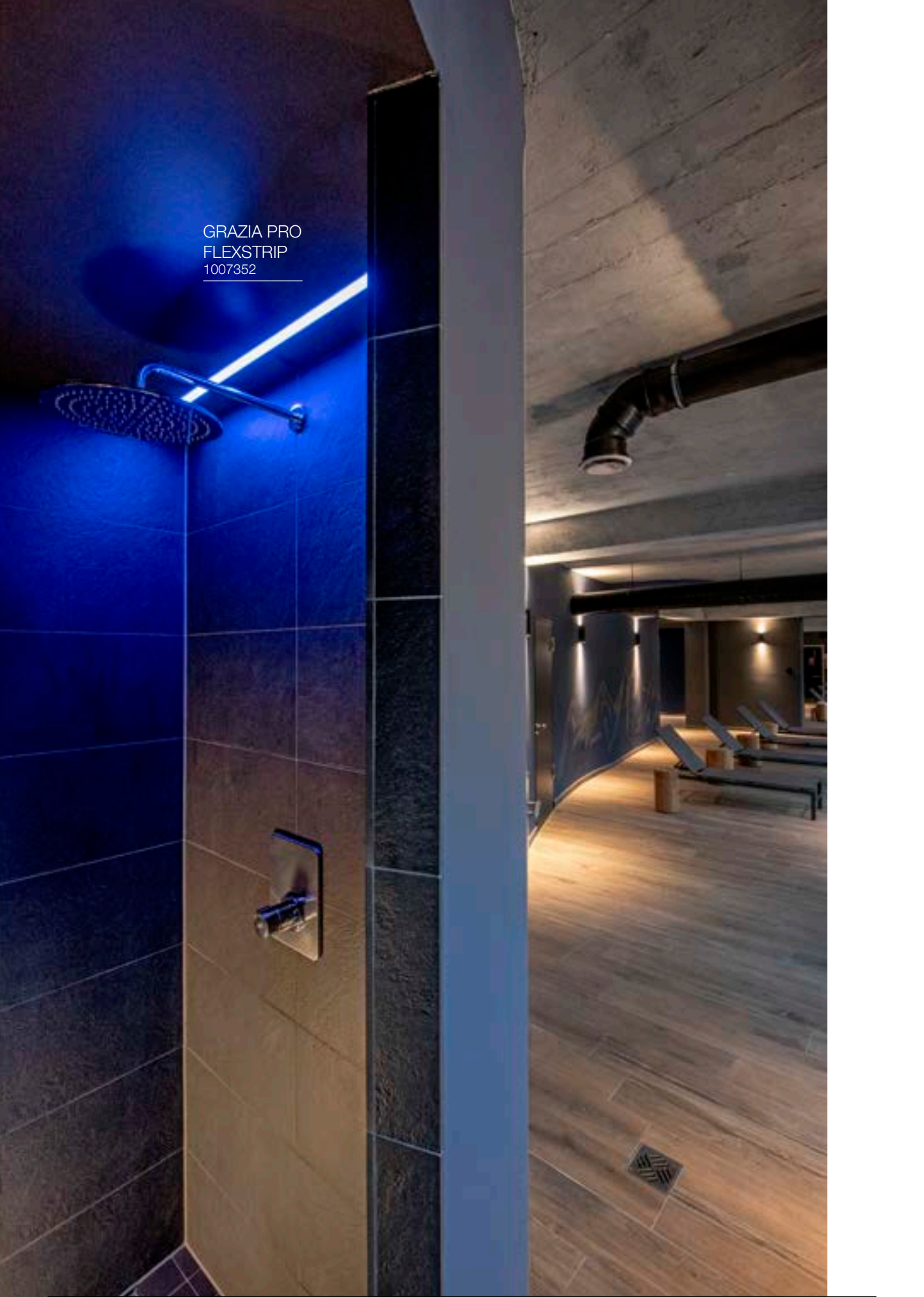

PROFILES



GRAZIA 10
SURFACE-MOUNTED
PROFILE | 567



GRAZIA 10
RECESSED PROFILE
| 567

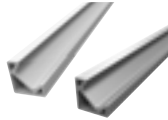

GRAZIA 10 EDGE | 570

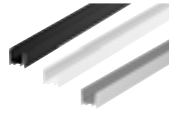

GRAZIA 20
SURFACE-MOUNTED
PROFILE | 573



GRAZIA 20
RECESSED PROFILE
| 573

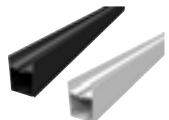

GRAZIA 60
SURFACE-MOUNTED
PROFILE | 577

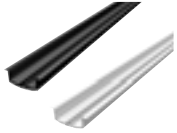

GRAZIA 60
RECESSED PROFILE
| 577



GRAZIA 10
ACCESSORIES | 569



GRAZIA 10 EDGE
ACCESSORIES | 571



GRAZIA 20
ACCESSORIES |
574-575



GRAZIA 60
ACCESSORIES |
578-579

LED STRIPS



GRAZIA
FLEXSTRIP LED | 582



GRAZIA PRO
FLEXSTRIP LED | 583



GRAZIA PRO MAX
FLEXSTRIP | 585



GRAZIA PRO
FLEXSTRIP
TUNABLE WHITE | 587



GRAZIA PRO
FLEXSTRIP
RGBW | 589



GRAZIA IP
FLEXSTRIP | 591



GRAZIA
FLEXSTRIP LED
ACCESSORIES | 582



GRAZIA PRO
FLEXSTRIP LED
ACCESSORIES | 583



GRAZIA PRO MAX
FLEXSTRIP
ACCESSORIES | 585



GRAZIA PRO
FLEXSTRIP
TUNABLE WHITE
ACCESSORIES | 587



GRAZIA PRO FLEX-
STRIP RGBW ACCES-
SORIES | 589

TAHA
1007380



MEDO® PRO 90
1007309



ABRIDOR



ADEGAN



AINOS



ALPA





ALTRA DICE



SCKET

ALTRA DICE | 263



SCKET

ALTRA DICE | 263



SCKET

ALTRA DICE | 408



SCKET

ALTRA DICE
TRACK | 521



SCKET

ALTRA DICE
TRACK | 556

ANELA



LED

ANELA | 261



LED

ANELA | 306

ARROCK



SCKET

ARROCK
GRANITE 40/70 | 647



SCKET

ARROCK ARC | 648



LED

ARROCK
STONE 50/75 | 649



SCKET

ARROCK SLOT | 649

ASTINA



SCKET

ASTINA | 261



SCKET

ASTINA | 305



ASTINA
UP/DOWN | 379



SCKET

ASTINA | 761



SCKET

ASTINA STEEL | 761

ASTO



SCKET

ASTO TUBE | 285



SCKET

ASTO TUBE | 285



SCKET

ASTO TUBE | 285



SCKET

ASTO TUBE | 285



NEW

SCKET

ASTO TUBE | 347



NEW

SCKET

ASTO TUBE | 347



NEW

SCKET

ASTO TUBE | 395



NEW

SCKET

ASTO TUBE | 397



NEW

SCKET

ASTO TUBE | 397



NEW

SCKET

ASTO TUBE | 399



NEW

SCKET

ASTO TUBE | 397



SCKET

ASTO | 415



SCKET

ASTO | 415



SCKET

ASTO | 415



NEW

SCKET

ASTO TUBE | 505

AVO



SCKET

AVO | 413



SCKET

AVO | 413



SCKET

AVO | 413



SCKET

AVO | 413



SCKET

AVO | 415



SCKET

AVO TRACK | 515/561

BIMA



SCKET

BIMA | 519



SCKET

BIMA | 519



SCKET

BIMA | 559



SCKET

BIMA | 559



BOOKAT



LED

BOOKAT | 751



LED

BOOKAT | 683

BOX



SCKET

BOX-L | 773



LED

BOX-L | 773



SCKET

BOX UP/DOWN | 773

BRICK



LED

BRICK MESH | 825



LED

BRICK | 825



LED

BRICK | 825



SCKET

BRICK
DOWNUNDER | 827



LED

BRICK
DOWNUNDER | 827

BULAN



SCKET

BULAN | 815



SCKET

BULAN GRID | 815

CARISO



LED
CARISO | 368



LED
CARISO | 368

CONCRETO



SOCKET
CONCRETO | 627



SOCKET
CONCRETO | 627



NEW

LED
CONCRETO M | 717



NEW

LED
CONCRETO L | 717



NEW

SOCKET
CONCRETO | 821



NEW

LED
CONCRETO | 821

CONTONE®



LED
CONTONE® | 231



LED
CONTONE® | 231

CUBE



NEW

LED
S-CUBE 35/75 | 607



NEW

LED
R-CUBE 35/70 | 609



NEW

LED
S-CUBE | 791



NEW

LED
R-CUBE | 805



NEW

LED
S-CUBE | 805



DASAR®



LED
DASAR® 600 | 831



LED
DASAR® 1200 | 831



LED
DASAR® S | 833



LED
DASAR® S | 833



LED
DASAR® L | 835



LED
DASAR® L | 835



LED
DASAR® XL | 837



LED
DASAR® XL | 837



LED
DASAR® FLAT 80 | 839



LED
DASAR® FLAT 120 | 839



LED
DASAR® 255 | 839



LED
DASAR® 920 | 840



LED
DASAR® 920 | 840



LED
DASAR® 270 | 841



LED
DASAR® 270 | 841



SCKET
DASAR® 115 | 843



SCKET
DASAR® 115 | 843



SCKET
DASAR® 115 | 843



SCKET
DASAR® EXACT 116 | 845



SCKET
DASAR® EXACT 116 | 845



SCKET
DASAR® 215 | 846



SCKET
DASAR® 215 | 846



SCKET
DASAR® 215 | 847



LED
DASAR® 215 | 847



LED
DASAR® PROJECTOR | 698



LED
DASAR® 920 | 698

DIO FLEX



SCKET
DIO FLEX PLATE | 387



LED
DIO FLEX PLATE | 387



LED
DIO FLEX PLATE | 387

DOLIX



SCKET

DOLIX OUT | 235



SCKET

DOLIX OUT | 235

DOWNUNDER OUT



LED

DOWNUNDER
OUT | 769



LED

DOWNUNDER
OUT | 769



LED

DOWNUNDER
OUT S | 823



LED

DOWNUNDER
OUT M | 823



LED

DOWNUNDER
OUT L | 823

ENOLA



SCKET

ENOLA B | 259



LED

ENOLA C | 259



SCKET

ENOLA B | 305



SCKET

ENOLA | 305



ENOLA B | 379



ENOLA B | 379



SCKET

ENOLA B | 407



SCKET

ENOLA B | 407



SCKET

ENOLA B | 407



LED

ENOLA C TRACK | 516



LED

ENOLA C TRACK | 517



SCKET

ENOLA B TRACK | 517



SCKET

ENOLA B | 517



LED

ENOLA C TRACK | 561



NEW

LED

ENOLA
OCULUS | 723



NEW

LED

ENOLA
OCULUS | 723



LED

ENOLA
OCULUS S | 725



LED

ENOLA
OCULUS M | 725



LED
ENOLA
ROUND L | 725



LED
ENOLA ROUND S
UP/DOWN | 727



LED
ENOLA ROUND M
UP/DOWN | 727



LED
ENOLA ROUND L
UP/DOWN | 727



LED
ENOLA
SQUARE S | 729



LED
ENOLA
SQUARE M | 729



LED
ENOLA
SQUARE L | 729



LED
ENOLA SQUARE S
UP/DOWN | 730



LED
ENOLA SQUARE M
UP/DOWN | 730



LED
ENOLA SQUARE L
UP/DOWN | 730



LED
ENOLA
OCULUS | 792



LED
ENOLA
ROUND S | 793



LED
ENOLA
ROUND M | 793



LED
ENOLA
ROUND L | 793



LED
ENOLA
SQUARE S | 795



LED
ENOLA
SQUARE M | 795



LED
ENOLA S
SQUARE L | 795

ESKINA



LED
ESKINA
FRAME 45/75 | 629



LED
ESKINA
FRAME 75 | 629



LED
ESKINA FRAME
125/175 | 630



LED
ESKINA 30/80 | 631



LED
ESKINA FRAME | 749



LED
ESKINA FRAME | 749



LED
ESKINA FRAME | 749



LED
ESKINA D | 783



LED
ESKINA FRAME | 791



LED
ESKINA SPOT
SENSOR | 807



LED
ESKINA SPOT | 807

EURO SPOT



SCKET

EURO SPOT
TRACK | 521



SCKET

EURO SPOT
TRACK | 555



SCKET

EURO SPOT
TRACK | 555

FENDA



SCKET

FENDA | 266



SCKET

FENDA | 296



SCKET

FENDA | 447



SCKET

FENDA | 447



SCKET

FENDA | 447



SCKET

FENDA | 448



SCKET

FENDA BOW
BASIS | 448



SCKET

FENDA | 380



FENDA | 380



FENDA | 296



FENDA | 296, 448



FENDA | 267, 297, 449



FENDA | 267, 297, 449



FENDA | 267, 297, 449

FITU



SCKET

FITU | 295



SCKET

FITU | 376



SCKET

FITU CUBE | 376



FLATT



LED

FLATT 65/100 | 679



LED

FLATT SENSOR | 760



LED

FLATT | 760

FORCHINI



SCKET

FORCHINI 50 | 312



SCKET

FORCHINI 70 | 312



SCKET

FORCHINI M 40 | 313



SCKET

FORCHINI M 50 | 313



SCKET

FORCHINI M 40
TRACK | 512



SCKET

FORCHINI M 40
TRACK | 554

F-POL



SCKET

F-POL | 672



SCKET

F-POL | 778

GLENOS®



LED

GLENOS® | 291



LED

GLENOS® | 291



LED

GLENOS® 60 | 339

GLOO PURE



SCKET

GLOO PURE
27/44/70 | 655



SCKET

GLOO PURE | 777

GRAFIT



SCKET

GRAFIT 30/60/90 | 635



SCKET

GRAFIT 30/60/90 | 637



SCKET

GRAFIT | 742



SCKET

GRAFIT | 742



SCKET

GRAFIT | 743



SCKET

GRAFIT | 743

HELIA



LED

HELIA
AMBIENT 35 | 300



LED

HELIA
AMBIENT 35 | 300



LED

HELIA 30 | 301



LED

HELIA 30 | 301



LED

HELIA 40 | 303



LED

HELIA 40 | 303



LED

HELIA 50 TRACK | 507



LED

HELIA 50 TRACK | 561



LED

HELIA SPOT S | 699



LED

HELIA SPOT L | 699



LED

HELIA | 809



LED

HELIA | 809



HORN



LED
HORN MINI | 218



SCKET
HORN | 219



SCKET
HORN | 219



SCKET
HORN | 219



SCKET
HORN | 220



SCKET
HORN | 220



SCKET
HORN | 220



SCKET
HORN-T | 221



LED
HORN MAGNA | 221

H-POL



LED
H-POL 30/60 | 676



LED
H-POL TWIN
30/60 | 677

IPERI



LED
IPERI 50 | 681



LED
IPERI | 780

I-RING



LED
I-RING | 613



LED
I-RING | 714

KADUX



LED
KADUX | 213



LED
KADUX | 213



LED
KADUX | 213



SCKET
KADUX | 214



SCKET
KADUX | 214



SCKET
KADUX | 214



SCKET
KADUX | 215



SCKET
KADUX | 215

KALU



LED
KALU | 403



LED
KALU | 403



LED
KALU | 403



LED
KALU | 403



SCKET
KALU | 405



SCKET
KALU | 405



SCKET
KALU | 405



SCKET
KALU | 405



LED
KALU TRACK | 520



SCKET
KALU TRACK | 520



LED
KALU TRACK
LED | 558



SCKET
KALU TRACK | 558



KARDAMOD



SCKET

KARDAMOD | 265



SCKET

KARDAMOD | 265

KARPO



LED

KARPO 30 | 232



LED

KARPO MAGN | 382



LED

KARPO GOOSE | 382



LED

KARPO 30 | 383



LED

KARPO | 383



LED

KARPO 30 | 399



LED

KARPO | 452



LED

KARPO | 452

LALU®



NEW

LED

LALU® | 177



NEW

LED

LALU® | 177



NEW

LALU® TETRA 14 | 178



NEW

LALU® TETRA 24 | 178



NEW

LALU® TETRA 36 | 178



NEW

LALU® CONE 15 | 178



NEW

LALU® ELYPSE 15 | 178



NEW

LALU® ELYPSE 22 | 178



NEW

LALU® ELYPSE 33 | 178



NEW

LALU® PLATE 15 | 178



NEW

LALU® PLATE 22 | 178



NEW

SCKET

LALU® | 183

LID



LED
LID I 75 | 611

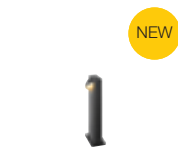

LED
LID I 45 | 611

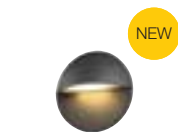

LED
LID II | 711

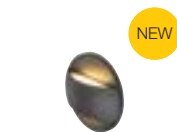

LED
LID II | 711



LED
LID I | 713



LED
LID I | 713

LIGHT EYE



SCKET
LIGHT EYE® 90 | 314



SCKET
LIGHT EYE® 150 | 314



SCKET
LIGHT EYE® 90 | 511



SCKET
LIGHT EYE® 150 | 511

LIPSY



LED
LIPSY® 30 | 423



LED
LIPSY® 40 | 423



LED
LIPSY® 50 | 423



LED
LIPSY® 30 | 425



LED
LIPSY® 40 | 425



LED
LIPSY® 50 | 425



LED
LIPSY® 40 | 426



LED
LIPSY® 50 | 426



LISENNE



SOCKET
LISENNE | 306



SOCKET
LISENNE | 375



SOCKET
LISENNE 40/70 | 662

L-LINE



LED
L-LINE 60 | 341



LED
L-LINE 120 | 341



LED
L-LINE OUT 30 | 650



LED
L-LINE OUT 60 | 651



LED
L-LINE
OUT 50/80 | 651



LED
L-LINE OUT | 775

LOGS



LED
LOGS IN | 362



LED
LOGS IN | 362



LED
LOGS IN L | 363



LED
LOGS IN L | 363



LED
LOGS 40/70 | 633



LED
LOGS | 775

MAGANDA



LED
MAGANDA | 337



LED
MAGANDA | 453

MEDO® PRO 40
1006414 (DC)

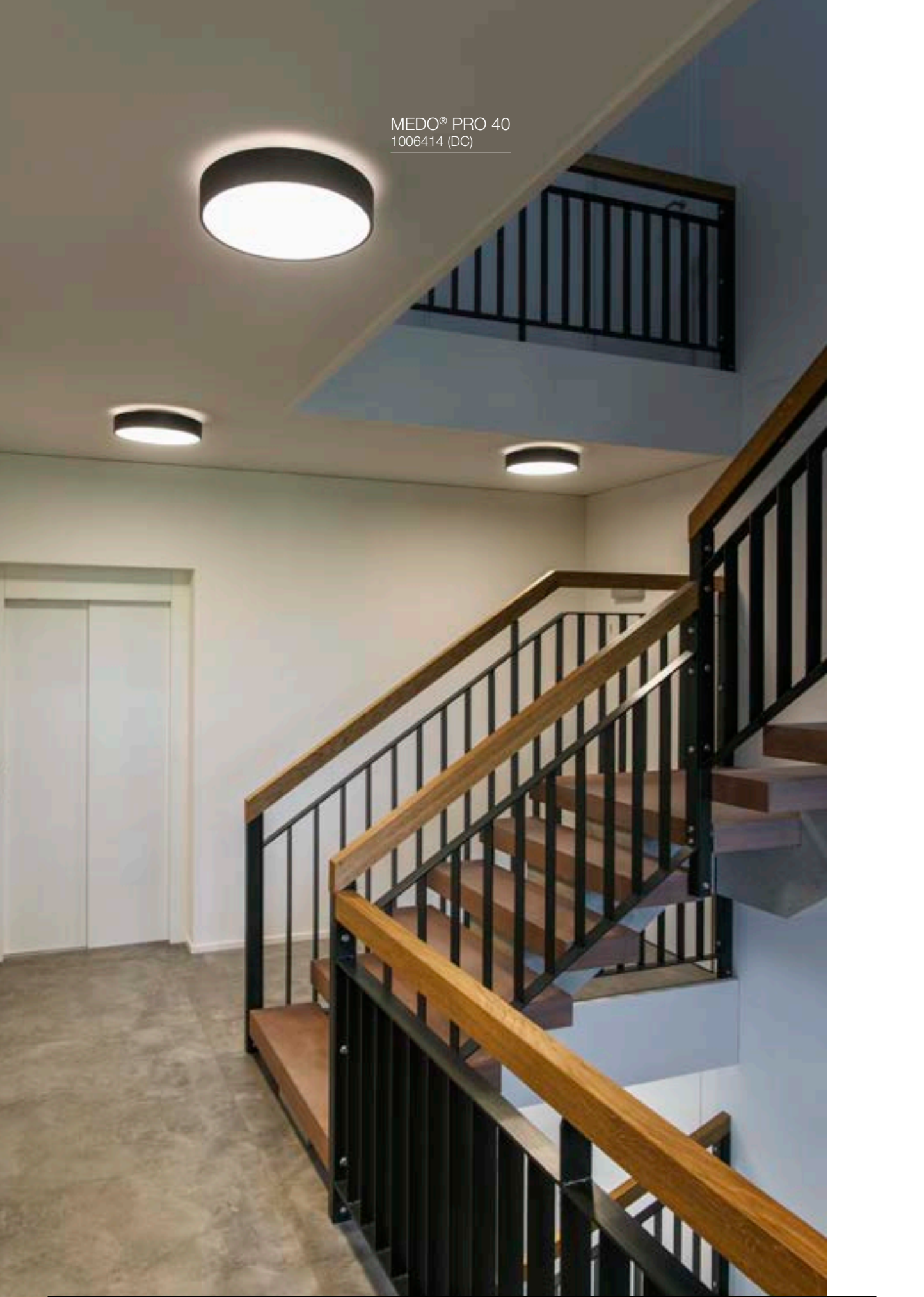



MANA



MANA
BASE | 349, 720



MANA BASE | 349



MANA 40 | 319



MANA 60 | 349



MANA | 351



MANA | 351



MANA | 351



MANA | 353



MANA | 353



MANA | 353

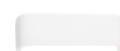

MANA | 353



RUSTY® MANA | 720



NEW

RUSTY® MANA | 720



MANA OUT | 721



NEW



MANA OUT | 721

MEDO



NEW



MEDO® PRO
30 | 150, 152, 157



NEW



MEDO® PRO
40 | 150, 152, 157



NEW



MEDO® PRO
60 | 151, 153, 157



NEW



MEDO® PRO
90 | 151, 153, 157



NEW



MEDO® 30 | 161



NEW



MEDO® 40 | 161



NEW



MEDO® 60 | 161



NEW



MEDO® 90 | 161

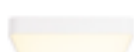

MEDO® 60 | 165



MEDO® RING 60 | 167



MEDO® RING 90 | 167



MEDO® 30 | 170



MEDO® 40 | 170



MEDO® 60 | 170



MEDO® 30 | 171



MEDO® 40 | 171



MEDO® 60 | 171

MERIDIAN



SOCKET

MERIDIAN | 746



SOCKET

MERIDIAN BOX | 746



SOCKET

MERIDIAN BOX
SENSOR | 747



SOCKET

MERIDIAN BOX | 747

MOLAT



SOCKET

MOLAT | 661



SOCKET

MOLAT | 661



SOCKET

MOLAT | 777



SOCKET

MOLAT | 799

M-POL



LED

M-POL S | 614



LED

M-POL S | 615



LED

M-POL S | 616



LED

M-POL S | 617



LED

M-POL S | 618



LED

M-POL M | 619



LED

M-POL M | 620



LED

M-POL M | 621



M-POL 30/60/90 | 623



MYRA



SCKET

MYRA SPOT | 685



SCKET

MYRA
UP/DOWN | 764



SCKET

MYRA | 811

NAUTILUS



SCKET

NAUTILUS 10 | 694



SCKET

BIG NAUTILUS | 694



SCKET

NAUTILUS 10 | 695



LED

NAUTILUS 10 | 696



SCKET

NAUTILUS | 697



SCKET

NAUTILUS 10
SPOT | 697



LED

NAUTILUS 10
SPOT LED | 697



SCKET

NAUTILUS | 785

NEW TRIA®

NEW



LED

NEW TRIA®
68 | 134, 135

NEW



LED

NEW TRIA®
68 | 134, 135

NEW



LED

NEW TRIA® UNIVERSAL
68 | 136, 137

NEW



LED

NEW TRIA® UNIVERSAL
68 | 136, 137

NEW



LED

NEW TRIA® 75 | 137



LED

NEW TRIA® 68 | 138

NEW



LED

NEW TRIA® 68 | 138

NEW



LED

NEW TRIA® 75 | 138

NEW



LED

NEW TRIA® 75 | 138

NEW



LED

NEW TRIA® 75 XL | 139

NEW



LED

NEW TRIA® 75 XL | 139

NEW TRIA®



LED
NEW TRIA® 45 | 141



LED
NEW TRIA® 155 | 141



LED
NEW TRIA® 150 | 145



LED
NEW TRIA® 150 | 145



LED
NEW TRIA® 155 | 145



LED
NEW TRIA® 300 | 145

NOBLO®



LED
NOBLO® | 401



LED
NOBLO® | 401



LED
NOBLO® | 401



LED
NOBLO® SPOT | 491



LED
NOBLO® SPOT | 501



LED
NOBLO® SPOT | 501



LED
NOBLO® SPOT | 503



LED
NOBLO® SPOT | 503



LED
NOBLO® SPOT | 545



LED
NOBLO® SPOT | 545



LED
NOBLO® SPOT | 547



LED
NOBLO® SPOT | 547

NUMINOS®



LED
NUMINOS® XS | 84



LED
NUMINOS® S | 84



LED
NUMINOS® M | 85



LED
NUMINOS® L | 85



LED
NUMINOS® XL | 85



LED
NUMINOS® MOVE
XS | 86



LED
NUMINOS® MOVE
S | 86



LED
NUMINOS® MOVE
M | 87



LED
NUMINOS® MOVE
L | 87



LED
NUMINOS® MOVE
XL | 87



NUMINOS® GIMBLE XS | 88



NUMINOS® GIMBLE S | 88



NUMINOS® GIMBLE M | 89



NUMINOS® GIMBLE L | 89



NUMINOS® GIMBLE XL | 89



NEW



NUMINOS® PROJECTOR XS | 92



NEW



NUMINOS® PROJECTOR S | 92



NEW



NUMINOS® PROJECTOR M | 93



NEW



NUMINOS® PROJECTOR XL | 93



NUMINOS® S | 100



NUMINOS® M | 100



NUMINOS® L | 101



NUMINOS® XL | 101



NUMINOS® S | 104



NUMINOS® M | 104



NUMINOS® L | 105



NUMINOS® XL | 105



NUMINOS® S | 108



NUMINOS® M | 108



NUMINOS® L | 109



NUMINOS® XL | 109



NUMINOS® S | 112



NUMINOS® M | 112



NUMINOS® L | 113



NUMINOS® XL | 113



NUMINOS® ZOOM M | 115



NEW



NUMINOS® 48V XS | 468

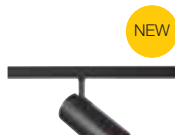

NEW



NUMINOS® 48V S | 468



NEW



NUMINOS® 48V XS | 470



NEW



NUMINOS® 48V S | 470

OCCULDAS



LED
OCCULDAS 14 | 230



LED
OCCULDAS 23 | 230



LED
OCCULDAS 13 | 262



LED
OCCULDAS 23 | 262

OCULUS



LED
OCULUS | 229



LED
OCULUS | 258



LED
OCULUS | 294



NEW

LED
OCULUS | 355

ONE®



LED
ONE® 60 | 188



LED
ONE® 60 | 188



LED
ONE® 80 | 188



LED
ONE® 80 | 188



LED
ONE® DOUBLE | 189



LED
ONE® TRIPLE | 189



NEW

LED
ONE® CUBE | 189



NEW

LED
ONE® CUBE | 189



LED
ONE® LINEAR 100 | 191



LED
ONE® LINEAR 140 | 191



LED
ONE® 40 | 193



LED
ONE® 60 | 193



LED
ONE® 40 TRACK | 194



NEW

LED
ONE® STRAIGHT | 196



NEW

LED
ONE® BOW | 197



OVALISK



LED
OVALISK 75/100 | 653



LED
OVALISK
SENSOR | 757



LED
OVALISK | 757



LED
OVALISK | 797

PANEL



LED
LED PANEL | 243



LED
PANEL 60 | 274



LED
PANEL | 275



LED
PANEL 60 | 275



LED
PANEL | 275



LED
PANEL 60 | 289



LED
PANEL TRACK | 507



LED
PANEL TRACK | 507

PANTILO



SCKET
PANTILO
ROPE 19 | 279



SCKET
PANTILO
ROPE 20 | 279



SCKET
PANTILO
ROPE 27 | 279



SCKET
PANTILO
OVAL | 281



SCKET
PANTILO 20 | 281



SCKET
PANTILO 28 | 281



SCKET
PANTILO
CONVEX 29/40 | 283

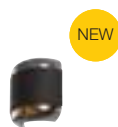

SCKET
PANTILO
ROPE | 345



SCKET
PANTILO
ROPE 19 | 393

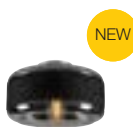

SCKET
PANTILO
ROPE 27 | 393



SCKET
PANTILO
ROPE 19 | 505



SCKET
PANTILO
ROPE 19 | 549

PARA



SCKET

PARA DOME | 318



PARA DOME | 318



PARA DOME | 318



SCKET

PARA 380 | 319

PARA CONE



SCKET

PARA CONE GL | 309



SCKET

PARA CONE 20 | 309



SCKET

PARA CONE 30 | 309



SCKET

PARA CONE GL | 508



SCKET

PARA CONE GL | 508



SCKET

PARA CONE 14 | 509



SCKET

PARA CONE 14 | 509



SCKET

PARA CONE GL | 552



SCKET

PARA CONE GL | 552



SCKET

PARA CONE 14 | 553



SCKET

PARA CONE 14 | 553

PATTA



LED

PATTA-I | 244



LED

PATTA-I | 244



LED

PATTA-I | 245



LED

PATTA-I | 245



LED

PATTA-F | 246



LED

PATTA-F | 247



PEMA



LED
PEMA® | 758



LED
PEMA® | 759



LED
PEMA® | 759



SCKET
PEMA® | 759

PHELIA



SCKET
PHELIA 10 | 310



SCKET
PHELIA 20 | 311



SCKET
PHELIA 25 | 311



SCKET
PHELIA 30 | 311



SCKET
PHELIA | 388



SCKET
PHELIA | 453

PHOTONI



SCKET
PHOTONI 45/75 | 605



SCKET
PHOTONI | 709

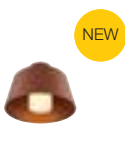

SCKET
PHOTONI | 789

PHOTONIA



SCKET
PHOTONIA | 659



SCKET
PHOTONIA | 659



SCKET
PHOTONIA | 777



SCKET
PHOTONIA | 799

PIKA



SCKET

PIKA | 228



SCKET

PIKA | 228

PLASTRA



SCKET

PLASTRA | 233



SCKET

PLASTRA | 233



SCKET

PLASTRA | 270



LED

PLASTRA | 271



SCKET

PLASTRA 105 | 271



SCKET

PLASTRA 104 | 271



SCKET

PLASTRA | 356



SCKET

PLASTRA | 356



SCKET

PLASTRA | 357



SCKET

PLASTRA | 357



SCKET

PLASTRA | 359



LED

PLASTRA | 359



LED

PLASTRA | 359



SCKET

PLASTRA | 360



SCKET

PLASTRA 101 | 361



SCKET

PLASTRA | 361



SCKET

PLASTRA 104 | 361

POWER TRAIL-LITE



LED

POWER TRAIL-LITE® | 849



LED

POWER TRAIL-LITE® | 849



PURI



SCKET
PURI | 411



SCKET
PURI | 411



SCKET
PURI | 411



SCKET
PURI | 411



SCKET
PURI TRACK | 513



SCKET
PURI TRACK | 513



SCKET
PURI TRACK | 515



SCKET
PURI TRACK | 557



SCKET
PURI TRACK
GLASS | 557

Q-LINE®



LED
Q-LINE® | 253



LED
Q-LINE® | 253



LED
Q-LINE® | 293



LED
Q-LINE® | 293



LED
Q-LINE® | 293



LED
Q-LINE® | 341

QUAD



LED
QUAD FRAME 9 | 240



LED
QUAD FRAME 14 | 364



LED
QUAD FRAME 19 | 364



LED
BIG QUAD | 752



LED
QUAD | 752



LED
QUAD
UP/DOWN 15 | 753



LED
BIG QUAD
UP/DOWN | 755



LED
BIG QUAD | 755

QUADRASS



SCKET

QUADRASS | 307



SCKET

QUADRASS | 375



LED

QUADRASS
SPOT | 375

QUADRASYL



SCKET

QUADRASYL 75 | 682



SCKET

QUADRASYL | 781

QUADRULO



LED

QUADRULO | 639



LED

QUADRULO | 744



SCKET

QUADRULO
SENSOR | 745



SCKET

QUADRULO | 745



LED

QUADRULO | 811

RASCALI



LED

RASCALI 45/65 | 684



LED

RASCALI | 780



ROCCI



LED

ROCCI | 854



LED

ROCCI | 854



LED

ROCCI 200 | 855



LED

ROCCI 200 | 855

ROTBALL



SCKET

ROTBALL 25 | 317



SCKET

ROTBALL 40 | 317



SCKET

ROTBALL 50 | 317



SCKET

ROTBALL
25/40/50 | 657

ROX



SCKET

ROX ACRYL
30/60/90 | 669



SCKET

ROX UP/DOWN | 767



SCKET

ROX | 767



SCKET

ROX | 801



SCKET

ROX | 801

RUSTY®



LED
RUSTY®
SLOT 50/80 | 640



SCKET
RUSTY®
SLOT 50/80 | 641



SCKET
RUSTY®
PATHLIGHT | 642



LED
RUSTY® 40/70 | 643



SCKET
RUSTY® 40/70 | 643



SCKET
RUSTY®
CONE 24 | 645



SCKET
RUSTY®
CONE 40/70 | 645



SCKET
RUSTY® 40/70 | 646



RUSTY® MANA | 720



RUSTY® MANA | 720



LED
RUSTY®
UP/DOWN | 756



LED
RUSTY®
UP/DOWN | 756

SENDER



LED
SENDER 12 | 223



LED
SENDER 18 | 223



LED
SENDER 24 | 223



LED
SENDER 12 | 225



LED
SENDER 18 | 225



LED
SENDER 24 | 225



LED
SENDER 12 | 417



LED
SENDER 18 | 417



LED
SENDER 24 | 417



LED
SENDER 12 | 419



LED
SENDER 18 | 419



LED
SENDER 24 | 419

SIGHT



LED
SIGHT 60 | 431



LED
SIGHT 115 | 431



LED
SIGHT TRACK | 550



LED
SIGHT TRACK | 550



LED
SIGHT MOVE | 551



LED
SIGHT MOVE | 551



SIMA



LED

SIMA | 420



LED

SIMA | 420



LED

SIMA | 421



LED

SIMA | 421

SITRA



SCKET

SITRA 360 | 685



SCKET

SITRA 360 SPIKE | 703



SCKET

SITRA 360 SPIKE | 703



LED

SITRA S | 739



LED

SITRA S | 739



LED

SITRA M | 741



LED

SITRA L | 741



SCKET

SITRA CUBE | 741



SCKET

SITRA | 801



SCKET

SITRA 360 | 808



LED

SITRA
UP/DOWN | 765



SCKET

SITRA
UP/DOWN | 765

SLOTS



LED

SLOTS 45/65 | 675



LED

SLOTS | 768

SOLASTO



SCKET
SOLASTO | 857



SCKET
SOLASTO | 857

SOMNILA



LED
SOMNILA SPOT | 384



LED
SOMNILA SPOT | 385



LED
SOMNILA FLEX | 385



LED
SOMNILA FLEX | 385

SQUARE



SCKET
SQUARE
POLE 30/60/90 | 673



SCKET
SQUARE | 779



SCKET
SQUARE TURN | 781

S-TUBE



SCKET
S-TUBE 32/75 | 603



SCKET
S-TUBE | 805



SUN



SCKET

SUN / BIG SUN | 315



NEW

SCKET

TINY SUN | 443



NEW

SCKET

LITTLE SUN | 443

SYNA



NEW

LED

SYNA PLANT | 689



NEW

LED

SYNA GARDEN | 689



LED

SYNA | 689

THEO



SCKET

THEO UP/DOWN | 377



SCKET

THEO PATHLIGHT | 652



SCKET

THEO BRACKET | 701



SCKET

THEO UP/DOWN | 735



LED

BIG THEO BEAM UP/FLOOD DOWN | 735



SCKET

BIG THEO UP/DOWN | 735



LED

BIG THEO FLOOD UP/DOWN | 736



SCKET

THEO | 736



SCKET

BIG THEO | 737



LED

BIG THEO | 737



LED

BIG THEO | 797



SCKET

BIG THEO | 797



SCKET

THEO BRACKET | 808

TRILEDO



SOCKET

TRILEDO | 255



SOCKET

TRILEDO | 255



SOCKET

TRILEDO | 255



LED

TRILEDO | 257



LED

TRILEDO | 257



LED

TRILEDO | 257

TRUKKO



LED

TRUKKO | 330



LED

TRUKKO | 330



NEW

LED

TRUKKO | 331



NEW

LED

TRUKKO 80 | 331



LED

TRUKKO 60 | 332

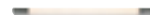

LED

TRUKKO 90 | 332

UNIVERSAL DOWNLIGHT



NEW

LED

UNIVERSAL
DOWNLIGHT | 205



NEW

LED

UNIVERSAL
DOWNLIGHT | 207



NEW

LED

UNIVERSAL
DOWNLIGHT | 208



NEW

LED

UNIVERSAL
DOWNLIGHT | 209

VILUA



LED

VILUA S | 763



LED

VILUA L | 763



LED

VILUA | 763



VINOLINA



LED
VINOLINA
ONE | 437, 597



LED
VINOLINA |
437,597



LED
VINOLINA
TWO | 439, 599

WL



LED
WL 149 | 334



SOCKET
WL 149 | 334



SOCKET
WL 106 | 335



SOCKET
WL 106 | 335

WORKLIGHT



LED
WORKLIGHT
PRO 120 | 287



LED
WORKLIGHT
PRO 150 | 287



LED
WORKLIGHT
PRO | 444



LED
WORKLIGHT
PRO | 444



LED
WORKLIGHT | 445



LED
WORKLIGHT | 445

NUMINOS® GIMBLE
1005817



Discover the
NUMINOS® Configurator
at [slv.com](https://www.slv.com)



NUMINOS® Downlights (DL)



The NUMINOS® DL
colours can be
chosen as desired



black - black



black - white



black - chrome



white - black



white - white



white - chrome



NUMINOS® GIMBLE
355° rotation and
60° pivot angle



NUMINOS® MOVE
355° rotation and
30° pivot angle



Low-voltage plug

XS 200mA Power consumption: 7W Material: aluminium/polycarbonate (PC) **S** 250mA Power consumption: 8.6W Material: aluminium/polycarbonate (PC)



















	2700K	20°	640lm	1005499	670lm	1003769
		40°	620lm	1005502	670lm	1003772
		55°	640lm	1005505	670lm	1003775
	3000K	20°	700lm	1005517	690lm	1003793
		40°	670lm	1005520	690lm	1003796
		55°	690lm	1005523	690lm	1003799
	4000K	20°	720lm	1005535	730lm	1003817
		40°	700lm	1005538	730lm	1003820
		55°	710lm	1005541	730lm	1003823
	2700K	20°	670lm	1005500	720lm	1003770
		40°	650lm	1005503	720lm	1003773
		55°	670lm	1005506	720lm	1003776
	3000K	20°	730lm	1005518	730lm	1003794
		40°	700lm	1005521	730lm	1003797
		55°	720lm	1005524	730lm	1003800
	4000K	20°	750lm	1005536	790lm	1003818
		40°	730lm	1005539	790lm	1003821
		55°	740lm	1005542	790lm	1003824
	2700K	20°	670lm	1005501	690lm	1003771
		40°	650lm	1005504	690lm	1003774
		55°	670lm	1005507	690lm	1003777
	3000K	20°	730lm	1005519	700lm	1003795
		40°	700lm	1005522	700lm	1003798
		55°	720lm	1005525	700lm	1003801
	4000K	20°	750lm	1005537	750lm	1003819
		40°	730lm	1005540	750lm	1003822
		55°	740lm	1005543	750lm	1003825
	2700K	20°	640lm	1005508	670lm	1003781
		40°	620lm	1005511	670lm	1003784
		55°	640lm	1005514	670lm	1003787
	3000K	20°	700lm	1005526	690lm	1003805
		40°	670lm	1005529	690lm	1003808
		55°	690lm	1005532	690lm	1003811
	4000K	20°	720lm	1005544	730lm	1003829
		40°	700lm	1005547	730lm	1003832
		55°	710lm	1005550	730lm	1003835
	2700K	20°	670lm	1005509	720lm	1003782
		40°	650lm	1005512	720lm	1003785
		55°	670lm	1005515	720lm	1003788
	3000K	20°	730lm	1005527	730lm	1003806
		40°	700lm	1005530	730lm	1003809
		55°	720lm	1005533	730lm	1003812
	4000K	20°	750lm	1005545	790lm	1003830
		40°	730lm	1005548	790lm	1003833
		55°	740lm	1005551	790lm	1003836
	2700K	20°	670lm	1005510	690lm	1003783
		40°	650lm	1005513	690lm	1003786
		55°	670lm	1005516	690lm	1003789
	3000K	20°	730lm	1005528	700lm	1003807
		40°	700lm	1005531	700lm	1003810
		55°	720lm	1005534	700lm	1003813
	4000K	20°	750lm	1005546	750lm	1003831
		40°	730lm	1005549	750lm	1003834
		55°	740lm	1005552	750lm	1003837



M 500mA
Power consumption: 17.5W
Material: aluminium/polycarbonate (PC)

L 700mA
Power consumption: 25.4W
Material: aluminium/polycarbonate (PC)

XL 1050mA
Power consumption: 37.4W
Material: aluminium/polycarbonate (PC)

	2700K	20°	1460lm	1003841	2150lm	1003913	3300lm	1003985
		40°	1460lm	1003844	2150lm	1003916	3300lm	1003988
		55°	1460lm	1003847	2150lm	1003919	3300lm	1003991
	3000K	20°	1500lm	1003865	2150lm	1003937	3300lm	1004009
		40°	1500lm	1003868	2150lm	1003940	3300lm	1004012
		55°	1500lm	1003871	2150lm	1003943	3300lm	1004015
	4000K	20°	1600lm	1003889	2350lm	1003961	3600lm	1004033
		40°	1600lm	1003892	2350lm	1003964	3600lm	1004036
		55°	1600lm	1003895	2350lm	1003967	3600lm	1004039
	2700K	20°	1600lm	1003842	2250lm	1003914	3500lm	1003986
		40°	1600lm	1003845	2250lm	1003917	3500lm	1003989
		55°	1600lm	1003848	2250lm	1003920	3500lm	1003992
	3000K	20°	1600lm	1003866	2300lm	1003938	3550lm	1004010
		40°	1600lm	1003869	2300lm	1003941	3550lm	1004013
		55°	1600lm	1003872	2300lm	1003944	3550lm	1004016
	4000K	20°	1750lm	1003890	2450lm	1003962	3800lm	1004034
		40°	1750lm	1003893	2450lm	1003965	3800lm	1004037
		55°	1750lm	1003896	2450lm	1003968	3800lm	1004040
	2700K	20°	1550lm	1003843	2150lm	1003915	3400lm	1003987
		40°	1550lm	1003846	2150lm	1003918	3400lm	1003990
		55°	1550lm	1003849	2150lm	1003921	3400lm	1003993
	3000K	20°	1550lm	1003867	2200lm	1003939	3500lm	1004011
		40°	1550lm	1003870	2200lm	1003942	3500lm	1004014
		55°	1550lm	1003873	2200lm	1003945	3500lm	1004017
	4000K	20°	1660lm	1003891	2350lm	1003963	3750lm	1004035
		40°	1660lm	1003894	2350lm	1003966	3750lm	1004038
		55°	1660lm	1003897	2350lm	1003969	3750lm	1004041
	2700K	20°	1460lm	1003853	2150lm	1003925	3300lm	1003997
		40°	1460lm	1003856	2150lm	1003928	3300lm	1004000
		55°	1460lm	1003859	2150lm	1003931	3300lm	1004003
	3000K	20°	1500lm	1003877	2150lm	1003949	3300lm	1004021
		40°	1500lm	1003880	2150lm	1003952	3300lm	1004024
		55°	1500lm	1003883	2150lm	1003955	3300lm	1004027
	4000K	20°	1600lm	1003901	2350lm	1003973	3600lm	1004045
		40°	1600lm	1003904	2350lm	1003976	3600lm	1004048
		55°	1600lm	1003907	2350lm	1003979	3600lm	1004051
	2700K	20°	1600lm	1003854	2250lm	1003926	3500lm	1003998
		40°	1600lm	1003857	2250lm	1003929	3500lm	1004001
		55°	1600lm	1003860	2250lm	1003932	3500lm	1004004
	3000K	20°	1600lm	1003878	2300lm	1003950	3550lm	1004022
		40°	1600lm	1003881	2300lm	1003953	3550lm	1004025
		55°	1600lm	1003884	2300lm	1003956	3550lm	1004028
	4000K	20°	1750lm	1003902	2450lm	1003974	3800lm	1004046
		40°	1750lm	1003905	2450lm	1003977	3800lm	1004049
		55°	1750lm	1003908	2450lm	1003980	3800lm	1004052
	2700K	20°	1550lm	1003855	2150lm	1003927	3400lm	1003999
		40°	1550lm	1003858	2150lm	1003930	3400lm	1004002
		55°	1550lm	1003861	2150lm	1003933	3400lm	1004005
	3000K	20°	1550lm	1003879	2200lm	1003951	3500lm	1004023
		40°	1550lm	1003882	2200lm	1003954	3500lm	1004026
		55°	1550lm	1003885	2200lm	1003957	3500lm	1004029
	4000K	20°	1660lm	1003903	2350lm	1003975	3750lm	1004047
		40°	1660lm	1003906	2350lm	1003978	3750lm	1004050
		55°	1660lm	1003909	2350lm	1003981	3750lm	1004053

NUMINOS® MOVE DL



IP20

IK02

L80B50

355°

30°

10

Low-voltage plug

XS

200mA
Power consumption: 7W
Material: aluminium/polycarbonate (PC)

S

250mA
Power consumption: 8.6W
Material: aluminium/polycarbonate (PC)



















	2700K	20°	640lm	1005553	670lm	1005319
		40°	620lm	1005556	670lm	1005322
		55°	640lm	1005559	670lm	1005325
	3000K	20°	700lm	1005571	690lm	1005337
		40°	670lm	1005574	690lm	1005340
		55°	690lm	1005577	690lm	1005343
	4000K	20°	720lm	1005589	730lm	1005355
		40°	700lm	1005592	730lm	1005358
		55°	710lm	1005595	730lm	1005361
	2700K	20°	670lm	1005554	720lm	1005320
		40°	650lm	1005557	720lm	1005323
		55°	670lm	1005560	720lm	1005326
	3000K	20°	730lm	1005572	730lm	1005338
		40°	700lm	1005575	730lm	1005341
		55°	720lm	1005578	730lm	1005344
	4000K	20°	750lm	1005590	790lm	1005356
		40°	730lm	1005593	790lm	1005359
		55°	740lm	1005596	790lm	1005362
	2700K	20°	670lm	1005555	690lm	1005321
		40°	650lm	1005558	690lm	1005324
		55°	670lm	1005561	690lm	1005327
	3000K	20°	730lm	1005573	700lm	1005339
		40°	700lm	1005576	700lm	1005342
		55°	720lm	1005579	700lm	1005345
	4000K	20°	750lm	1005591	750lm	1005357
		40°	730lm	1005594	750lm	1005360
		55°	740lm	1005597	750lm	1005363
	2700K	20°	640lm	1005562	670lm	1005328
		40°	620lm	1005565	670lm	1005331
		55°	640lm	1005568	670lm	1005334
	3000K	20°	700lm	1005580	690lm	1005346
		40°	670lm	1005583	690lm	1005349
		55°	690lm	1005586	690lm	1005352
	4000K	20°	720lm	1005598	730lm	1005364
		40°	700lm	1005603	730lm	1005367
		55°	710lm	1005606	730lm	1005370
	2700K	20°	670lm	1005563	720lm	1005329
		40°	650lm	1005566	720lm	1005332
		55°	670lm	1005569	720lm	1005335
	3000K	20°	730lm	1005581	730lm	1005347
		40°	700lm	1005584	730lm	1005350
		55°	720lm	1005587	730lm	1005353
	4000K	20°	750lm	1005599	790lm	1005365
		40°	730lm	1005604	790lm	1005368
		55°	740lm	1005607	790lm	1005371
	2700K	20°	670lm	1005564	690lm	1005330
		40°	650lm	1005567	690lm	1005333
		55°	670lm	1005570	690lm	1005336
	3000K	20°	730lm	1005582	700lm	1005348
		40°	700lm	1005585	700lm	1005351
		55°	720lm	1005588	700lm	1005354
	4000K	20°	750lm	1005600	750lm	1005366
		40°	730lm	1005605	750lm	1005369
		55°	740lm	1005608	750lm	1005372



M 500mA
Power consumption: 17.5W
Material: aluminium/polycarbonate (PC)

L 700mA
Power consumption: 25.4W
Material: aluminium/polycarbonate (PC)

XL 1050mA
Power consumption: 37.4W
Material: aluminium/polycarbonate (PC)

	2700K	20°	1460lm	1003553	2150lm	1003625	3300lm	1003697
		40°	1460lm	1003556	2150lm	1003628	3300lm	1003700
		55°	1460lm	1003559	2150lm	1003631	3300lm	1003703
	3000K	20°	1500lm	1003577	2150lm	1003649	3300lm	1003721
		40°	1500lm	1003580	2150lm	1003652	3300lm	1003724
		55°	1500lm	1003583	2150lm	1003655	3300lm	1003727
	4000K	20°	1600lm	1003601	2350lm	1003673	3600lm	1003745
		40°	1600lm	1003604	2350lm	1003676	3600lm	1003748
		55°	1600lm	1003607	2350lm	1003679	3600lm	1003751
	2700K	20°	1600lm	1003554	2250lm	1003626	3500lm	1003698
		40°	1600lm	1003557	2250lm	1003629	3500lm	1003701
		55°	1600lm	1003560	2250lm	1003632	3500lm	1003704
	3000K	20°	1600lm	1003578	2300lm	1003650	3550lm	1003722
		40°	1600lm	1003581	2300lm	1003653	3550lm	1003725
		55°	1600lm	1003584	2300lm	1003656	3550lm	1003728
	4000K	20°	1750lm	1003602	2450lm	1003674	3800lm	1003746
		40°	1750lm	1003605	2450lm	1003677	3800lm	1003749
		55°	1750lm	1003608	2450lm	1003680	3800lm	1003752
	2700K	20°	1550lm	1003555	2150lm	1003627	3400lm	1003699
		40°	1550lm	1003558	2150lm	1003630	3400lm	1003702
		55°	1550lm	1003561	2150lm	1003633	3400lm	1003705
	3000K	20°	1550lm	1003579	2200lm	1003651	3500lm	1003723
		40°	1550lm	1003582	2200lm	1003654	3500lm	1003726
		55°	1550lm	1003585	2200lm	1003657	3500lm	1003729
	4000K	20°	1660lm	1003603	2350lm	1003675	3750lm	1003747
		40°	1660lm	1003606	2350lm	1003678	3750lm	1003750
		55°	1660lm	1003609	2350lm	1003681	3750lm	1003753
	2700K	20°	1460lm	1003565	2150lm	1003637	3300lm	1003709
		40°	1460lm	1003568	2150lm	1003640	3300lm	1003712
		55°	1460lm	1003571	2150lm	1003643	3300lm	1003715
	3000K	20°	1500lm	1003589	2150lm	1003661	3300lm	1003733
		40°	1500lm	1003592	2150lm	1003664	3300lm	1003736
		55°	1500lm	1003595	2150lm	1003667	3300lm	1003739
	4000K	20°	1600lm	1003613	2350lm	1003685	3600lm	1003757
		40°	1600lm	1003616	2350lm	1003688	3600lm	1003760
		55°	1600lm	1003619	2350lm	1003691	3600lm	1003763
	2700K	20°	1600lm	1003566	2250lm	1003638	3500lm	1003710
		40°	1600lm	1003569	2250lm	1003641	3500lm	1003713
		55°	1600lm	1003572	2250lm	1003644	3500lm	1003716
	3000K	20°	1600lm	1003590	2300lm	1003662	3550lm	1003734
		40°	1600lm	1003593	2300lm	1003665	3550lm	1003737
		55°	1600lm	1003596	2300lm	1003668	3550lm	1003740
	4000K	20°	1750lm	1003614	2450lm	1003686	3800lm	1003758
		40°	1750lm	1003617	2450lm	1003689	3800lm	1003761
		55°	1750lm	1003620	2450lm	1003692	3800lm	1003764
	2700K	20°	1550lm	1003567	2150lm	1003639	3400lm	1003711
		40°	1550lm	1003570	2150lm	1003642	3400lm	1003714
		55°	1550lm	1003573	2150lm	1003645	3400lm	1003717
	3000K	20°	1550lm	1003591	2200lm	1003663	3500lm	1003735
		40°	1550lm	1003594	2200lm	1003666	3500lm	1003738
		55°	1550lm	1003597	2200lm	1003669	3500lm	1003741
	4000K	20°	1660lm	1003615	2350lm	1003687	3750lm	1003759
		40°	1660lm	1003618	2350lm	1003690	3750lm	1003762
		55°	1660lm	1003621	2350lm	1003693	3750lm	1003765

NUMINOS® GIMBLE DL

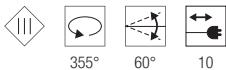

Low-voltage plug

XS 200mA Power consumption: 7W Material: aluminium/polycarbonate (PC) **S** 250mA Power consumption: 8.6W Material: aluminium/polycarbonate (PC)



















	2700K	20°	640lm	1005813	670lm	1005867
		40°	620lm	1005816	670lm	1005870
		55°	640lm	1005819	670lm	1005873
	3000K	20°	700lm	1005831	690lm	1005885
		40°	670lm	1005834	690lm	1005888
		55°	690lm	1005837	690lm	1005891
	4000K	20°	720lm	1005849	730lm	1005903
		40°	700lm	1005852	730lm	1005906
		55°	710lm	1005855	730lm	1005909
	2700K	20°	670lm	1005814	720lm	1005868
		40°	650lm	1005817	720lm	1005871
		55°	670lm	1005820	720lm	1005874
	3000K	20°	730lm	1005832	730lm	1005886
		40°	700lm	1005835	730lm	1005889
		55°	720lm	1005838	730lm	1005892
	4000K	20°	750lm	1005850	790lm	1005904
		40°	730lm	1005853	790lm	1005907
		55°	740lm	1005856	790lm	1005910
	2700K	20°	670lm	1005815	690lm	1005869
		40°	650lm	1005818	690lm	1005872
		55°	670lm	1005821	690lm	1005875
	3000K	20°	730lm	1005833	700lm	1005887
		40°	700lm	1005836	700lm	1005890
		55°	720lm	1005839	700lm	1005893
	4000K	20°	750lm	1005851	750lm	1005905
		40°	730lm	1005854	750lm	1005908
		55°	740lm	1005857	750lm	1005911
	2700K	20°	640lm	1005822	670lm	1005876
		40°	620lm	1005825	670lm	1005879
		55°	640lm	1005828	670lm	1005882
	3000K	20°	700lm	1005840	690lm	1005894
		40°	670lm	1005843	690lm	1005897
		55°	690lm	1005846	690lm	1005900
	4000K	20°	720lm	1005858	730lm	1005912
		40°	700lm	1005861	730lm	1005915
		55°	710lm	1005864	730lm	1005918
	2700K	20°	670lm	1005823	720lm	1005877
		40°	650lm	1005826	720lm	1005880
		55°	670lm	1005829	720lm	1005883
	3000K	20°	730lm	1005841	730lm	1005895
		40°	700lm	1005844	730lm	1005898
		55°	720lm	1005847	730lm	1005901
	4000K	20°	750lm	1005859	790lm	1005913
		40°	730lm	1005862	790lm	1005916
		55°	740lm	1005865	790lm	1005919
	2700K	20°	670lm	1005824	690lm	1005878
		40°	650lm	1005827	690lm	1005881
		55°	670lm	1005830	690lm	1005884
	3000K	20°	730lm	1005842	700lm	1005896
		40°	700lm	1005845	700lm	1005899
		55°	720lm	1005848	700lm	1005902
	4000K	20°	750lm	1005860	750lm	1005914
		40°	730lm	1005863	750lm	1005917
		55°	740lm	1005866	750lm	1005920



M 500mA
Power consumption: 17.5W
Material: aluminium/polycarbonate (PC)

L 700mA
Power consumption: 25.4W
Material: aluminium/polycarbonate (PC)

XL 1000/1050mA
Power consumption: 37.4W
Material: aluminium/polycarbonate (PC)

	2700K	20°	1460lm	1005921	2150lm	1005975	3300lm	1006029
		40°	1460lm	1005924	2150lm	1005978	3300lm	1006032
		55°	1460lm	1005927	2150lm	1005981	3300lm	1006035
	3000K	20°	1500lm	1005939	2150lm	1005993	3300lm	1006047
		40°	1500lm	1005942	2150lm	1005996	3300lm	1006050
		55°	1500lm	1005945	2150lm	1005999	3300lm	1006053
	4000K	20°	1600lm	1005957	2350lm	1006011	3600lm	1006065
		40°	1600lm	1005960	2350lm	1006014	3600lm	1006068
		55°	1600lm	1005963	2350lm	1006017	3600lm	1006071
	2700K	20°	1600lm	1005922	2250lm	1005976	3500lm	1006030
		40°	1600lm	1005925	2250lm	1005979	3500lm	1006033
		55°	1600lm	1005928	2250lm	1005982	3500lm	1006036
	3000K	20°	1600lm	1005940	2300lm	1005994	3550lm	1006048
		40°	1600lm	1005943	2300lm	1005997	3550lm	1006051
		55°	1600lm	1005946	2300lm	1006000	3550lm	1006054
	4000K	20°	1750lm	1005958	2450lm	1006012	3800lm	1006066
		40°	1750lm	1005961	2450lm	1006015	3800lm	1006069
		55°	1750lm	1005964	2450lm	1006018	3800lm	1006072
	2700K	20°	1550lm	1005923	2150lm	1005977	3400lm	1006031
		40°	1550lm	1005926	2150lm	1005980	3400lm	1006034
		55°	1550lm	1005929	2150lm	1005983	3400lm	1006037
	3000K	20°	1550lm	1005941	2200lm	1005995	3500lm	1006049
		40°	1550lm	1005944	2200lm	1005998	3500lm	1006052
		55°	1550lm	1005947	2200lm	1006001	3500lm	1006055
	4000K	20°	1660lm	1005959	2350lm	1006013	3750lm	1006067
		40°	1660lm	1005962	2350lm	1006016	3750lm	1006070
		55°	1660lm	1005965	2350lm	1006019	3750lm	1006073
	2700K	20°	1460lm	1005930	2150lm	1005984	3300lm	1006038
		40°	1460lm	1005933	2150lm	1005987	3300lm	1006041
		55°	1460lm	1005936	2150lm	1005990	3300lm	1006044
	3000K	20°	1500lm	1005948	2150lm	1006002	3300lm	1006056
		40°	1500lm	1005951	2150lm	1006005	3300lm	1006059
		55°	1500lm	1005954	2150lm	1006008	3300lm	1006062
	4000K	20°	1600lm	1005966	2350lm	1006020	3600lm	1006074
		40°	1600lm	1005969	2350lm	1006023	3600lm	1006077
		55°	1600lm	1005972	2350lm	1006026	3600lm	1006080
	2700K	20°	1600lm	1005931	2250lm	1005985	3500lm	1006039
		40°	1600lm	1005934	2250lm	1005988	3500lm	1006042
		55°	1600lm	1005937	2250lm	1005991	3500lm	1006045
	3000K	20°	1600lm	1005949	2300lm	1006003	3550lm	1006057
		40°	1600lm	1005952	2300lm	1006006	3550lm	1006060
		55°	1600lm	1005955	2300lm	1006009	3550lm	1006063
	4000K	20°	1750lm	1005967	2450lm	1006021	3800lm	1006075
		40°	1750lm	1005970	2450lm	1006024	3800lm	1006078
		55°	1750lm	1005973	2450lm	1006027	3800lm	1006081
	2700K	20°	1550lm	1005932	2150lm	1005986	3400lm	1006040
		40°	1550lm	1005935	2150lm	1005989	3400lm	1006043
		55°	1550lm	1005938	2150lm	1005992	3400lm	1006046
	3000K	20°	1550lm	1005950	2200lm	1006004	3500lm	1006058
		40°	1550lm	1005953	2200lm	1006007	3500lm	1006061
		55°	1550lm	1005956	2200lm	1006010	3500lm	1006064
	4000K	20°	1660lm	1005968	2350lm	1006022	3750lm	1006076
		40°	1660lm	1005971	2350lm	1006025	3750lm	1006079
		55°	1660lm	1005974	2350lm	1006028	3750lm	1006082

NUMINOS® PROJECTOR
1006978





NUMINOS® PROJECTOR Downlight (DL)



The application of the
NUMINOS® PROJECTOR
can be individually chosen



Expansion of the
NUMINOS® series
in sizes XS-L



NUMINOS® PROJECTOR DL Move



Low-voltage plug

XS 200mA
Power consumption: 7W Material:
aluminium

S 250mA
Power consumption: 8.6W
Material: aluminium









	2700K	20°	640lm	1006867	670lm	1006921
		40°	620lm	1006870	670lm	1006924
		55°	640lm	1006873	670lm	1006927
	3000K	20°	700lm	1006885	690lm	1006939
		40°	670lm	1006888	690lm	1006942
		55°	690lm	1006891	690lm	1006945
	2700K	20°	730lm	1006868	730lm	1006922
		40°	700lm	1006871	730lm	1006925
		55°	720lm	1006874	730lm	1006928
	3000K	20°	670lm	1006886	690lm	1006940
		40°	650lm	1006889	690lm	1006943
		55°	670lm	1006892	690lm	1006946
	2700K	20°	670lm	1006869	720lm	1006923
		40°	650lm	1006872	720lm	1006926
		55°	670lm	1006875	720lm	1006929
	3000K	20°	730lm	1006887	730lm	1006941
		40°	700lm	1006890	730lm	1006944
		55°	720lm	1006893	730lm	1006947
	2700K	20°	700lm	1006876	690lm	1006930
		40°	670lm	1006879	690lm	1006933
		55°	690lm	1006882	690lm	1006936
	3000K	20°	670lm	1006894	690lm	1006948
		40°	650lm	1006897	690lm	1006951
		55°	670lm	1006900	690lm	1006954
	2700K	20°	670lm	1006877	720lm	1006931
		40°	650lm	1006880	720lm	1006934
		55°	670lm	1006883	720lm	1006937
	3000K	20°	730lm	1006895	730lm	1006949
		40°	700lm	1006898	730lm	1006952
		55°	720lm	1006901	730lm	1006955
	2700K	20°	670lm	1006878	690lm	1006932
		40°	650lm	1006881	690lm	1006935
		55°	670lm	1006884	690lm	1006938
	3000K	20°	730lm	1006896	700lm	1006950
		40°	700lm	1006899	700lm	1006953
		55°	720lm	1006902	700lm	1006956

These lights are also available as 4000K versions on request (except XS).
Please note the different delivery times and minimum order quantities.



M 500mA
Power consumption: 17.5W
Material: aluminium

L 700mA
Power consumption: 25.4W
Material: aluminium

	2700K	20°	1460lm	1006975	2150lm	1007029
		40°	1460lm	1006978	2150lm	1007032
		55°	1460lm	1006981	2150lm	1007035
	3000K	20°	1500lm	1006993	2150lm	1007047
		40°	1500lm	1006996	2150lm	1007050
		55°	1500lm	1006999	2150lm	1007053
	2700K	20°	1600lm	1006976	2300lm	1007030
		40°	1600lm	1006979	2300lm	1007033
		55°	1600lm	1006982	2300lm	1007036
	3000K	20°	1550lm	1006994	2150lm	1007048
		40°	1550lm	1006997	2150lm	1007051
		55°	1550lm	1007000	2150lm	1007054
	2700K	20°	1600lm	1006977	2250lm	1007031
		40°	1600lm	1006980	2250lm	1007034
		55°	1600lm	1006983	2250lm	1007037
	3000K	20°	1600lm	1006995	2300lm	1007049
		40°	1600lm	1006998	2300lm	1007052
		55°	1600lm	1007001	2300lm	1007055
	2700K	20°	1500lm	1006984	2150lm	1007038
		40°	1500lm	1006987	2150lm	1007041
		55°	1500lm	1006990	2150lm	1007044
	3000K	20°	1550lm	1007002	2150lm	1007056
		40°	1550lm	1007005	2150lm	1007059
		55°	1550lm	1007008	2150lm	1007062
	2700K	20°	1600lm	1006985	2250lm	1007039
		40°	1600lm	1006988	2250lm	1007042
		55°	1600lm	1006991	2250lm	1007045
	3000K	20°	1600lm	1007003	2300lm	1007057
		40°	1600lm	1007006	2300lm	1007060
		55°	1600lm	1007009	2300lm	1007063
	2700K	20°	1550lm	1006986	2150lm	1007040
		40°	1550lm	1006989	2150lm	1007043
		55°	1550lm	1006992	2150lm	1007046
	3000K	20°	1550lm	1007004	2200lm	1007058
		40°	1550lm	1007007	2200lm	1007061
		55°	1550lm	1007010	2200lm	1007064

These lights are also available as 4000K versions on request (except XS).
Please note the different delivery times and minimum order quantities.

MATCHING DRIVER

XS S M L XL



LED driver 200mA, 10W QC	white	5,8W / 8,4W	-	IP20	L: 6.5 cm, W: 3.9 cm, H: 3.5 cm	1005610
LED driver 200mA, 10W, PHASE QC	white	6W / 8,4W	PHASE C		L: 8.5 cm, W: 4.1 cm, H: 3 cm	1005609
LED driver 200mA, 10W, DALI QC	white	3,8W / 13,5W	DALI		L: 18 cm, W: 4.5 cm, H: 3 cm	1005611
LED driver 200mA, 12W, DALI + RF Interface QC	white	1,5W / 12W	DALI + RF		L: 14.2 cm, W: 4.4 cm, H: 3 cm	1006457
LED driver 250mA, 10W	white	6,5W / 10W	-	IP20	L: 6.5 cm, W: 3.9 cm, H: 2 cm	1004058
LED driver 250mA, 10W, PHASE	white	7,5W / 10W	PHASE C		L: 8.5 cm, W: 3.9 cm, H: 3 cm	1004055
LED driver 250mA, 20W, DALI	white	1,5W / 15W	DALI		L: 15 cm, W: 5.2 cm, H: 2.8 cm	1004067
LED driver 250mA, 12W, DALI + RF Interface QC	white	1,5W / 12W	DALI + RF		L: 14.2 cm, W: 4.4 cm, H: 3 cm	1006458
LED driver 500mA, 30W	white	15W / 29,5W	-	IP20	L: 14.7 cm, W: 4.3 cm, H: 3 cm	1004064
LED driver 500mA, 30W, PHASE	white	12,5W / 21W	PHASE C		L: 11.5 cm, W: 4.1 cm, H: 2.5 cm	1004054
LED driver 500mA, 40W, DALI,	white	1,5W / 40,6W	DALI		L: 12.3 cm, W: 7.9 cm, H: 2.4 cm	1004069
LED driver 500mA, 42W, DALI + RF Interface QC	white	3,5W / 42W	DALI + RF		L: 12.3 cm, W: 7.9 cm, H: 3 cm	1006459
LED driver 700mA, 30W	white	15W / 29,5W	-	IP20	L: 14.7 cm, W: 4.3 cm, H: 3 cm	1004062
LED driver 700mA, 30W, PHASE	white	21W / 29,4W	PHASE C		L: 11.5 cm, W: 4.4 cm, H: 3 cm	1004065
LED driver 700mA, 40W, DALI	white	1,5W / 40,6W	DALI		L: 12.3 cm, W: 7.9 cm, H: 2.4 cm	1004070
LED driver 700mA, 42W, DALI + RF Interface QC	white	3,5W / 42W	DALI + RF		L: 12.3 cm, W: 7.9 cm, H: 3 cm	1006460
LED driver 1050mA, 40W	white	24W / 44W	-	IP20	L: 9.7 cm, W: 4.3 cm, H: 3 cm	1004059
LED driver 1000mA, 40W, PHASE	white	26,3W / 42W	PHASE C		L: 14.5 cm, W: 4 cm, H: 3 cm	1004066
LED driver 1050mA, 50W, DALI	white	4,2W / 50W	DALI		L: 12.3 cm, W: 7.9 cm, H: 2.4 cm	1004071



An old recessed ceiling light, often still fitted with conventional bulbs, should give way to an energy-efficient and cost-effective alternative. When removing the old fitting, a larger ceiling cut-out will often be required than before.

SLV has the perfect solution for this: the reducer ring completely covers the larger ceiling cut-out, while at the same time providing perfect support for your new, compact, recessed ceiling light. Our reducer rings are also perfectly coordinated with the NUMINOS® downlight and spotlight system.



DIFFUSERS AND REDUCER RINGS

XS S M L XL



Diffuser NUMINOS® XS	Ellipse	IP20	Diameter: 3.2 cm, H 0.2 cm	1005612
	Prism			1005613
	Frosted			1005614
	Honeycomb			1005615
Diffuser NUMINOS® S	Ellipse	IP20	Diameter: 4 cm, H: 0.2 cm	1004786
	Prism			1004787
	Frosted			1004788
	Honeycomb			1004789
Diffuser NUMINOS® M	Ellipse	IP20	Diameter: 4.75 cm, H 0.2 cm	1004790
	Prism			1004791
	Frosted			1004792
	Honeycomb			1004793
Diffuser NUMINOS® L	Ellipse	IP20	Diameter: 5.65 cm, H: 0.2 cm	1004794
	Prism			1004795
	Frosted			1004796
	Honeycomb			1004797
Diffuser NUMINOS® XL	Ellipse	IP20	Diameter: 7.1 cm, H: 0.2 cm	1004798
	Prism			1004799
	Frosted			1004800
	Honeycomb			1004801



Reducer ring <i>Round</i>	black	Ceiling cut-out: 8.5-13 cm	Outer diameter: 16 cm, Inner diameter: 7 cm H: 5.3 cm	1006135
				white
	black	Ceiling cut-out: 12-15 cm	Outer diameter: 16 cm, Inner diameter: 9 cm H: 5.3 cm	1006139
				white
	black	Ceiling cut-out: 14-18 cm	Outer diameter: 24 cm, Inner diameter: 12 cm H: 5.3 cm	1006143
				white
	black	Ceiling cut-out: 17-20 cm	Outer diameter: 24 cm, Inner diameter: 15 cm H: 5.3 cm	1006147
				white
	black	Ceiling cut-out: 20-22 cm	Outer diameter: 24 cm, Inner diameter: 18 cm H: 5.3 cm	1006151
				white
Reducer ring <i>Square</i>	black	Ceiling cut-out: 8.5-13 cm	Inner diameter: 7 cm L: 16 cm, W: 16 cm, H: 5.3 cm	1006137
				white
	black	Ceiling cut-out: 12-15 cm	Inner diameter: 9 cm L: 16 cm, W: 16 cm, H: 5.3 cm	1006141
				white
	black	Ceiling cut-out: 14-18 cm	Inner diameter: 12 cm L: 24 cm, W: 24 cm, H: 5.3 cm	1006145
				white
	black	Ceiling cut-out: 17-20 cm	Inner diameter: 15 cm L: 24 cm, W: 24 cm, H: 5.3 cm	1006149
				white
	black	Ceiling cut-out: 20-22 cm	Inner diameter: 18 cm L: 24 cm, W: 24 cm, H: 5.3 cm	1006153
				white

NUMINOS® PROJECTOR

What to choose for your NUMINOS® PROJECTOR:

You can choose from six colour versions, four housing sizes with different total wattages, two light colours and three half-diffusion angles of 20°, 44° and 55°.

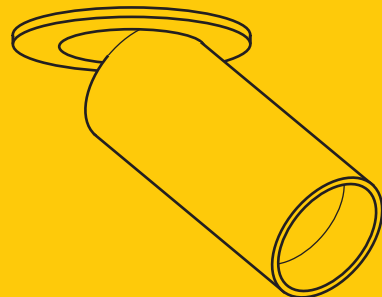
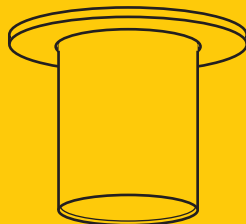
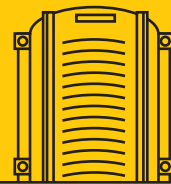
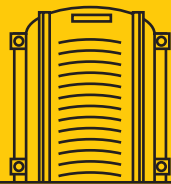
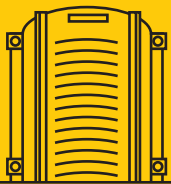

NUMINOS® is a perfectly coordinated lighting system that harmonises function, design and technology. For planners and doers. For every need. For maximum variety with minimum effort.



Discover the variety of
the NUMINOS® series
at slv.com

The new NUMINOS® PROJECTOR with a very high rotation and pivot range is a good complement to the NUMINOS® downlights, which have the same decorative and visual possibilities.

Available in four housing sizes with high-power LED module in two light colours.

LED drivers are available separately.

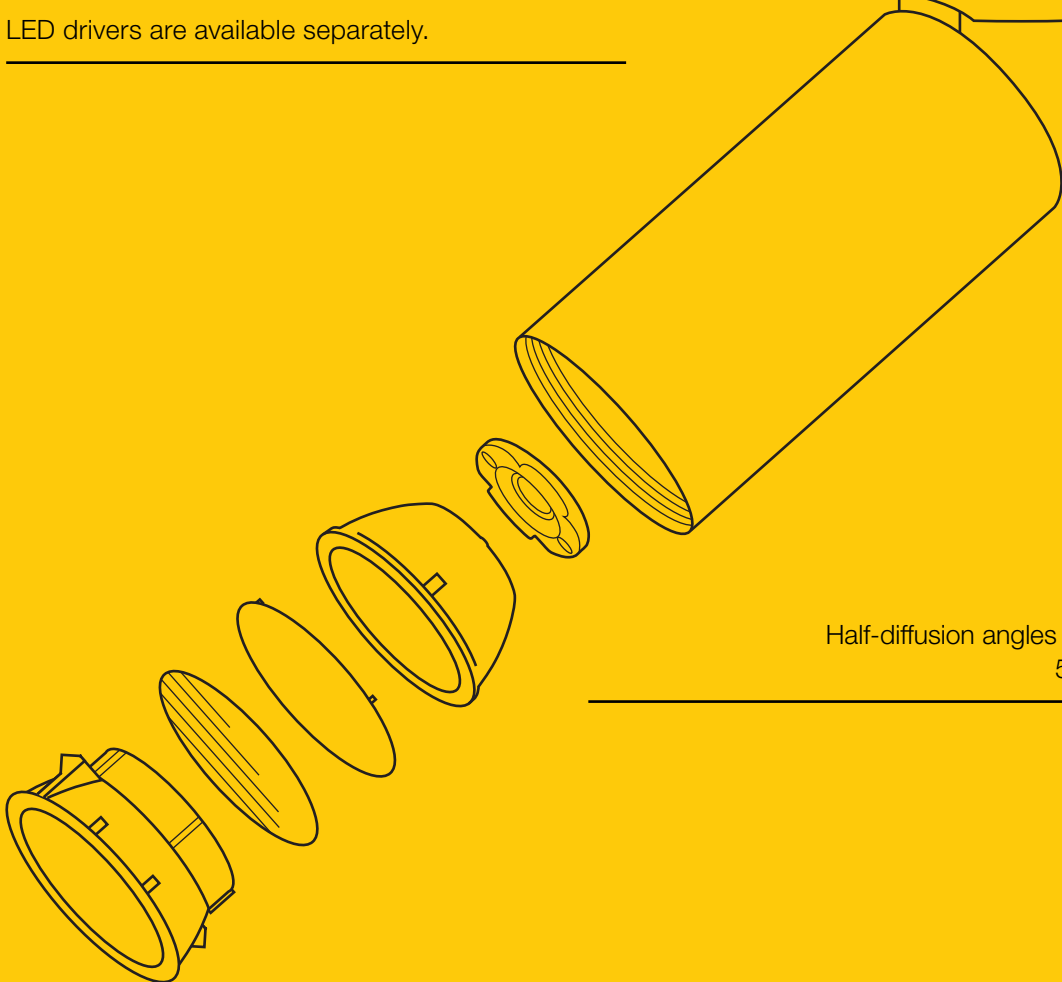
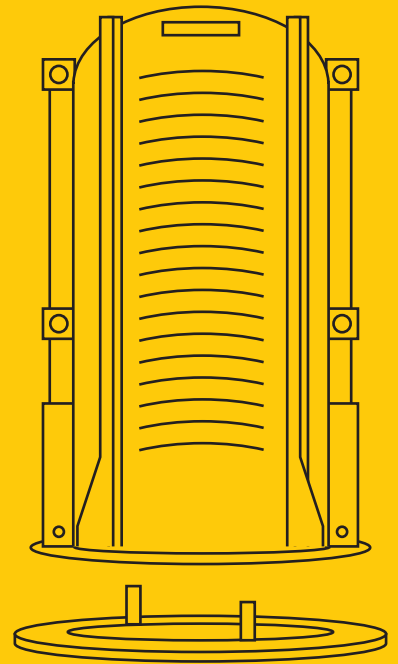

Half-diffusion angles of 20° | 40° |
55° available.

NUMINOS® CW
1004587

CLUB LOUNGE 1

TIVOLI





NUMINOS®
Ceiling and wall lights (CW)



NUMINOS® CW
Can be pivoted 90°
and rotated 350°

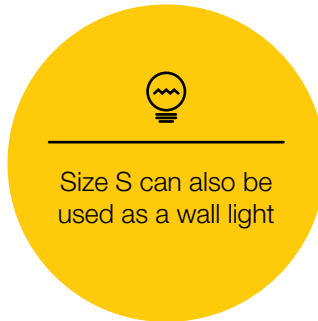

Decorative ring also
available in white



Decorative ring NUMINOS® S	Diameter: 6.2 cm, H: 2 cm	○	1006167
Decorative ring NUMINOS® M	Diameter: 8.2 cm, H: 2.4 cm	○	1006168
Decorative ring NUMINOS® L	Diameter: 9.65 cm, H: 2.5 cm	○	1006169
Decorative ring NUMINOS® XL	Diameter: 11.66 cm H: 2.85 cm	○	1006170



IP20













L80B50

350°

90°

S 220-240V ~50/60Hz | 250mA
Total wattage: 11W
Material: aluminium/polycarbonate (PC)

















M 220-240V ~50/60Hz | 500mA
Total wattage: 20W
Material: aluminium/polycarbonate (PC)

	2700K	24°	985lm	1004098	1925lm	1004194
		36°	985lm	1004099	1935lm	1004195
		60°	980lm	1004100	1885lm	1004196
	3000K	24°	1020lm	1004106	1955lm	1004202
		36°	1020lm	1004107	1970lm	1004203
		60°	1020lm	1004108	1880lm	1004204
	4000K	24°	1100lm	1004114	2125lm	1004210
		36°	1100lm	1004115	2120lm	1004211
		60°	1100lm	1004116	2060lm	1004212
	2700K	24°	985lm	1004386	1925lm	1004482
		36°	985lm	1004387	1935lm	1004483
		60°	980lm	1004388	1885lm	1004484
	3000K	24°	1020lm	1004394	1955lm	1004490
		36°	1020lm	1004395	1970lm	1004491
		60°	1020lm	1004396	1880lm	1004492
	4000K	24°	1100lm	1004402	2125lm	1004498
		36°	1100lm	1004403	2120lm	1004499
		60°	1100lm	1004404	2060lm	1004500
	2700K	24°	985lm	1004102	1925lm	1004198
		36°	985lm	1004103	1935lm	1004199
		60°	980lm	1004104	1885lm	1004200
	3000K	24°	1020lm	1004110	1955lm	1004206
		36°	1020lm	1004111	1970lm	1004207
		60°	1020lm	1004112	1880lm	1004208
	4000K	24°	1100lm	1004118	2125lm	1004214
		36°	1100lm	1004119	2120lm	1004215
		60°	1100lm	1004120	2060lm	1004216
	2700K	24°	985lm	1004390	1925lm	1004486
		36°	985lm	1004391	1935lm	1004487
		60°	980lm	1004392	1885lm	1004488
	3000K	24°	1020lm	1004398	1955lm	1004494
		36°	1020lm	1004399	1970lm	1004495
		60°	1020lm	1004400	1880lm	1004496
	4000K	24°	1100lm	1004406	2125lm	1004502
		36°	1100lm	1004407	2120lm	1004503
		60°	1100lm	1004408	2060lm	1004504



L 220-240V ~50/60Hz | 700mA
 Total wattage: 28W
 Material: aluminium/polycarbonate (PC)

XL 220-240V ~50/60Hz | 900mA
 Total wattage: 36W
 Material: aluminium/polycarbonate (PC)

		2700K	24°	2440lm	1004290	3290lm	1006083
			36°	2400lm	1004291	3250lm	1006084
			60°	2475lm	1004292	2980lm	1006085
		3000K	24°	2430lm	1004298	3530lm	1006089
			36°	2340lm	1004299	3490lm	1006090
			60°	2400lm	1004300	3210lm	1006091
		4000K	24°	2675lm	1004306	3800lm	1006095
			36°	2620lm	1004307	3760lm	1006096
			60°	2715lm	1004308	3460lm	1006097
		2700K	24°	2440lm	1004578	3290lm	1005741
			36°	2400lm	1004579	3250lm	1005742
			60°	2475lm	1004580	2980lm	1005743
		3000K	24°	2430lm	1004586	3530lm	1005747
			36°	2340lm	1004587	3490lm	1005748
			60°	2400lm	1004588	3210lm	1005749
		4000K	24°	2675lm	1004594	3800lm	1005753
			36°	2620lm	1004595	3760lm	1005754
			60°	2715lm	1004596	3460lm	1005755
		2700K	24°	2440lm	1004294	3290lm	1006086
			36°	2400lm	1004295	3250lm	1006087
			60°	2475lm	1004296	2980lm	1006088
		3000K	24°	2430lm	1004302	3530lm	1006092
			36°	2340lm	1004303	3490lm	1006093
			60°	2400lm	1004304	3210lm	1006094
		4000K	24°	2675lm	1004310	3800lm	1006098
			36°	2620lm	1004311	3760lm	1006099
			60°	2715lm	1004312	3460lm	1006100
		2700K	24°	2440lm	1004582	3290lm	1005744
			36°	2400lm	1004583	3250lm	1005745
			60°	2475lm	1004584	2980lm	1005746
		3000K	24°	2430lm	1004590	3530lm	1005750
			36°	2340lm	1004591	3490lm	1005751
			60°	2400lm	1004592	3210lm	1005752
		4000K	24°	2675lm	1004598	3800lm	1005756
			36°	2620lm	1004599	3760lm	1005757
			60°	2715lm	1004600	3460lm	1005758

NUMINOS® CL
1004227





NUMINOS®
Ceiling lights (CL)



Decorative ring also available in white



Decorative ring <i>NUMINOS® S</i>	Diameter: 6.2 cm, H: 2 cm	<input type="radio"/>	1006167
Decorative ring <i>NUMINOS® M</i>	Diameter: 8.2 cm, H: 2.4 cm	<input type="radio"/>	1006168
Decorative ring <i>NUMINOS® L</i>	Diameter: 9.65 cm, H: 2.5 cm	<input type="radio"/>	1006169
Decorative ring <i>NUMINOS® XL</i>	Diameter: 11.66 cm H: 2.85 cm	<input type="radio"/>	1006170

Detailed measurements and assembly information can be found on pages 118–119



IP20 L80B50

S 220-240V ~50/60Hz | 250mA
Total wattage: 11W
Material: aluminium/polycarbonate (PC)

















M 220-240V ~50/60Hz | 500mA
Total wattage: 20W
Material: aluminium/polycarbonate (PC)

	2700K	24°	985lm	1004122	1925lm	1004218
		36°	985lm	1004123	1935lm	1004219
		60°	980lm	1004124	1885lm	1004220
	3000K	24°	1020lm	1004130	1955lm	1004226
		36°	1020lm	1004131	1970lm	1004227
		60°	1020lm	1004132	1880lm	1004228
	4000K	24°	1100lm	1004138	2125lm	1004234
		36°	1100lm	1004139	2120lm	1004235
		60°	1100lm	1004140	2060lm	1004236
	2700K	24°	985lm	1004410	1925lm	1004506
		36°	985lm	1004411	1935lm	1004507
		60°	980lm	1004412	1885lm	1004508
	3000K	24°	1020lm	1004418	1955lm	1004514
		36°	1020lm	1004419	1970lm	1004515
		60°	1020lm	1004420	1880lm	1004516
	4000K	24°	1100lm	1004426	2125lm	1004522
		36°	1100lm	1004427	2120lm	1004523
		60°	1100lm	1004428	2060lm	1004524
	2700K	24°	985lm	1004126	1925lm	1004222
		36°	985lm	1004127	1935lm	1004223
		60°	980lm	1004128	1885lm	1004224
	3000K	24°	1020lm	1004134	1955lm	1004230
		36°	1020lm	1004135	1970lm	1004231
		60°	1020lm	1004136	1880lm	1004232
	4000K	24°	1100lm	1004142	2125lm	1004238
		36°	1100lm	1004143	2120lm	1004239
		60°	1100lm	1004144	2060lm	1004240
	2700K	24°	985lm	1004414	1925lm	1004510
		36°	985lm	1004415	1935lm	1004511
		60°	980lm	1004416	1885lm	1004512
	3000K	24°	1020lm	1004422	1955lm	1004518
		36°	1020lm	1004423	1970lm	1004519
		60°	1020lm	1004424	1880lm	1004520
	4000K	24°	1100lm	1004430	2125lm	1004526
		36°	1100lm	1004431	2120lm	1004527
		60°	1100lm	1004432	2060lm	1004528



L 220-240V ~50/60Hz | 700mA
 Total wattage: 28W
 Material: aluminium/polycarbonate (PC)

XL 220-240V ~50/60Hz | 900mA
 Total wattage: 36W
 Material: aluminium/polycarbonate (PC)

		2700K	24°	2440lm	1004314	3290lm	1005687
			36°	2400lm	1004315	3250lm	1005688
			60°	2475lm	1004316	2980lm	1005689
		3000K	24°	2430lm	1004322	3530lm	1005693
			36°	2340lm	1004323	3490lm	1005694
			60°	2400lm	1004324	3210lm	1005695
		4000K	24°	2675lm	1004330	3800lm	1005699
			36°	2620lm	1004331	3760lm	1005700
			60°	2715lm	1004332	3460lm	1005701
		2700K	24°	2440lm	1004602	3290lm	1005759
			36°	2400lm	1004603	3250lm	1005760
			60°	2475lm	1004604	2980lm	1005761
		3000K	24°	2430lm	1004610	3530lm	1005765
			36°	2340lm	1004611	3490lm	1005766
			60°	2400lm	1004612	3210lm	1005767
		4000K	24°	2675lm	1004618	3800lm	1005771
			36°	2620lm	1004619	3760lm	1005772
			60°	2715lm	1004620	3460lm	1005773
		2700K	24°	2440lm	1004318	3290lm	1005690
			36°	2400lm	1004319	3250lm	1005691
			60°	2475lm	1004320	2980lm	1005692
		3000K	24°	2430lm	1004326	3530lm	1005696
			36°	2340lm	1004327	3490lm	1005697
			60°	2400lm	1004328	3210lm	1005698
		4000K	24°	2675lm	1004334	3800lm	1005702
			36°	2620lm	1004335	3760lm	1005703
			60°	2715lm	1004336	3460lm	1005704
		2700K	24°	2440lm	1004606	3290lm	1005762
			36°	2400lm	1004607	3250lm	1005763
			60°	2475lm	1004608	2980lm	1005764
		3000K	24°	2430lm	1004614	3530lm	1005768
			36°	2340lm	1004615	3490lm	1005769
			60°	2400lm	1004616	3210lm	1005770
		4000K	24°	2675lm	1004622	3800lm	1005774
			36°	2620lm	1004623	3760lm	1005775
			60°	2715lm	1004624	3460lm	1005776

NUMINOS® PD
1005787





NUMINOS®
Pendant lights (PD)



Decorative ring also available in white



Decorative ring <i>NUMINOS® S</i>	Diameter: 6.2 cm, H: 2 cm	<input type="radio"/>	1006167
Decorative ring <i>NUMINOS® M</i>	Diameter: 8.2 cm, H: 2.4 cm	<input type="radio"/>	1006168
Decorative ring <i>NUMINOS® L</i>	Diameter: 9.65 cm, H: 2.5 cm	<input type="radio"/>	1006169
Decorative ring <i>NUMINOS® XL</i>	Diameter: 11.66 cm, H: 2.85 cm	<input type="radio"/>	1006170

Detailed measurements and assembly information can be found on pages 118–119

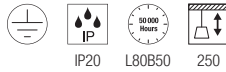

<p>S 220-240V ~50/60Hz 250mA Total wattage: 11W Material: aluminium/polycarbonate (PC)</p>	<p>M 220-240V ~50/60Hz 500mA Total wattage: 20W Material: aluminium/polycarbonate (PC)</p>
---	---

	2700K	24°	985lm	1004146	1925lm	1004242
		36°	985lm	1004147	1935lm	1004243
		60°	980lm	1004148	1885lm	1004244
	3000K	24°	1020lm	1004154	1955lm	1004250
		36°	1020lm	1004155	1970lm	1004251
		60°	1020lm	1004156	1880lm	1004252
	4000K	24°	1100lm	1004162	2125lm	1004258
		36°	1100lm	1004163	2120lm	1004259
		60°	1100lm	1004164	2060lm	1004260
	2700K	24°	985lm	1004434	1925lm	1004530
		36°	985lm	1004435	1935lm	1004531
		60°	980lm	1004436	1885lm	1004532
	3000K	24°	1020lm	1004442	1955lm	1004538
		36°	1020lm	1004443	1970lm	1004539
		60°	1020lm	1004444	1880lm	1004540
	4000K	24°	1100lm	1004450	2125lm	1004546
		36°	1100lm	1004451	2120lm	1004547
		60°	1100lm	1004452	2060lm	1004548
	2700K	24°	985lm	1004150	1925lm	1004246
		36°	985lm	1004151	1935lm	1004247
		60°	980lm	1004152	1885lm	1004248
	3000K	24°	1020lm	1004158	1955lm	1004254
		36°	1020lm	1004159	1970lm	1004255
		60°	1020lm	1004160	1880lm	1004256
	4000K	24°	1100lm	1004166	2125lm	1004262
		36°	1100lm	1004167	2120lm	1004263
		60°	1100lm	1004168	2060lm	1004264
	2700K	24°	985lm	1004438	1925lm	1004534
		36°	985lm	1004439	1935lm	1004535
		60°	980lm	1004440	1885lm	1004536
	3000K	24°	1020lm	1004446	1955lm	1004542
		36°	1020lm	1004447	1970lm	1004543
		60°	1020lm	1004448	1880lm	1004544
	4000K	24°	1100lm	1004454	2125lm	1004550
		36°	1100lm	1004455	2120lm	1004551
		60°	1100lm	1004456	2060lm	1004552



L 220-240V ~50/60Hz | 700mA
 Total wattage: 28W
 Material: aluminium/polycarbonate (PC)

XL 220-240V ~50/60Hz | 900mA
 Total wattage: 36W
 Material: aluminium/polycarbonate (PC)

	2700K	24°	2440lm	1004338	3290lm	1005705
		36°	2400lm	1004339	3250lm	1005706
		60°	2475lm	1004340	2980lm	1005707
	3000K	24°	2430lm	1004346	3530lm	1005711
		36°	2340lm	1004347	3490lm	1005712
		60°	2400lm	1004348	3210lm	1005713
	4000K	24°	2675lm	1004354	3800lm	1005717
		36°	2620lm	1004355	3760lm	1005718
		60°	2715lm	1004356	3460lm	1005719
	2700K	24°	2440lm	1004626	3290lm	1005777
		36°	2400lm	1004627	3250lm	1005778
		60°	2475lm	1004628	2980lm	1005779
	3000K	24°	2430lm	1004634	3530lm	1005783
		36°	2340lm	1004635	3490lm	1005784
		60°	2400lm	1004636	3210lm	1005785
	4000K	24°	2675lm	1004642	3800lm	1005789
		36°	2620lm	1004643	3760lm	1005790
		60°	2715lm	1004644	3460lm	1005791
	2700K	24°	2440lm	1004342	3290lm	1005708
		36°	2400lm	1004343	3250lm	1005709
		60°	2475lm	1004344	2980lm	1005710
	3000K	24°	2430lm	1004350	3530lm	1005714
		36°	2340lm	1004351	3490lm	1005715
		60°	2400lm	1004352	3210lm	1005716
	4000K	24°	2675lm	1004358	3800lm	1005720
		36°	2620lm	1004359	3760lm	1005721
		60°	2715lm	1004360	3460lm	1005722
	2700K	24°	2440lm	1004630	3290lm	1005780
		36°	2400lm	1004631	3250lm	1005781
		60°	2475lm	1004632	2980lm	1005782
	3000K	24°	2430lm	1004638	3530lm	1005786
		36°	2340lm	1004639	3490lm	1005787
		60°	2400lm	1004640	3210lm	1005788
	4000K	24°	2675lm	1004646	3800lm	1005792
		36°	2620lm	1004647	3760lm	1005793
		60°	2715lm	1004648	3460lm	1005794

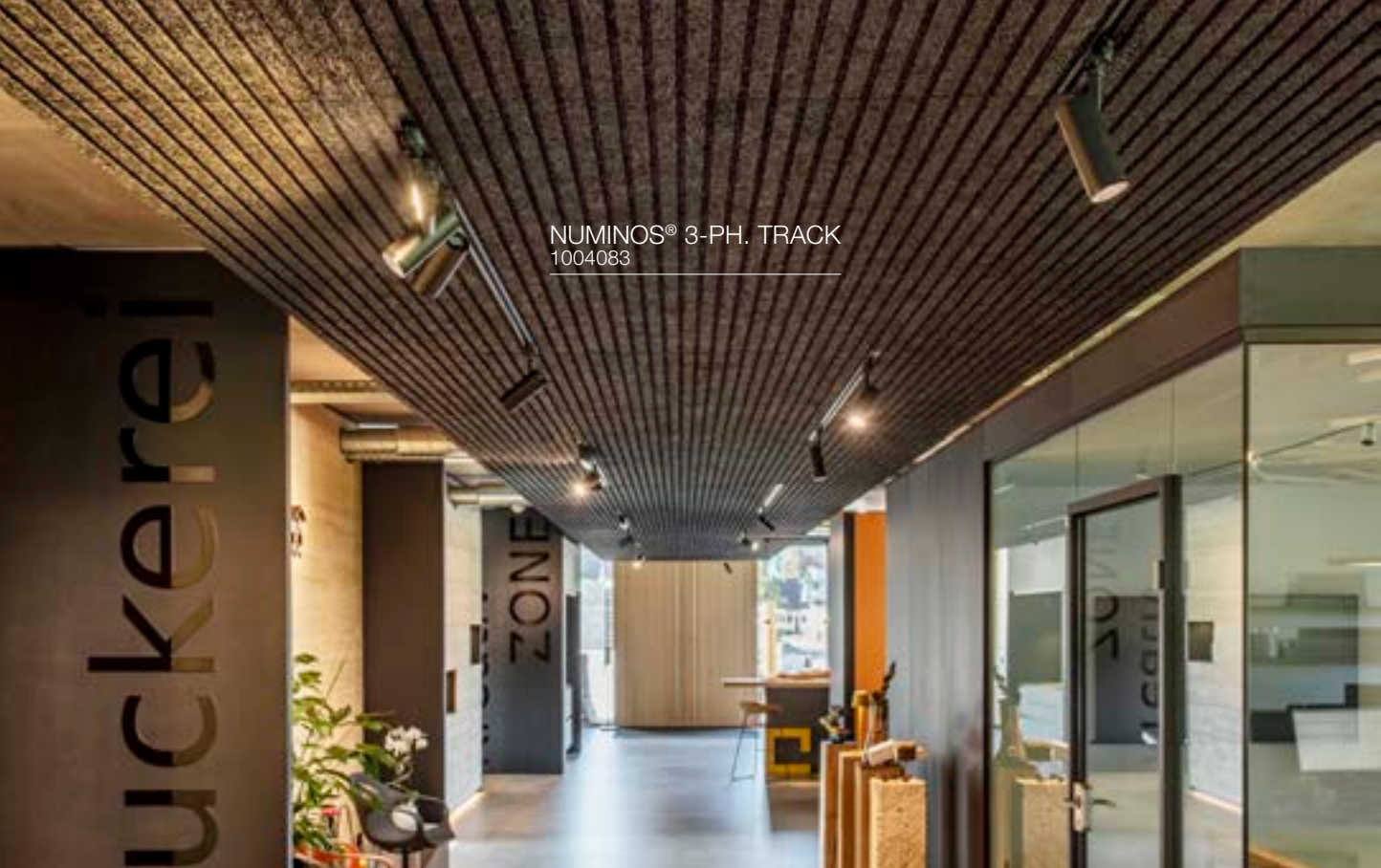

NUMINOS® 3-PH. TRACK
1004083



NUMINOS®
3-phase track system



Discover NUMINOS®
lights for the
48V system on
pages 468–471



NUMINOS® 3-PH. TRACK
1004082

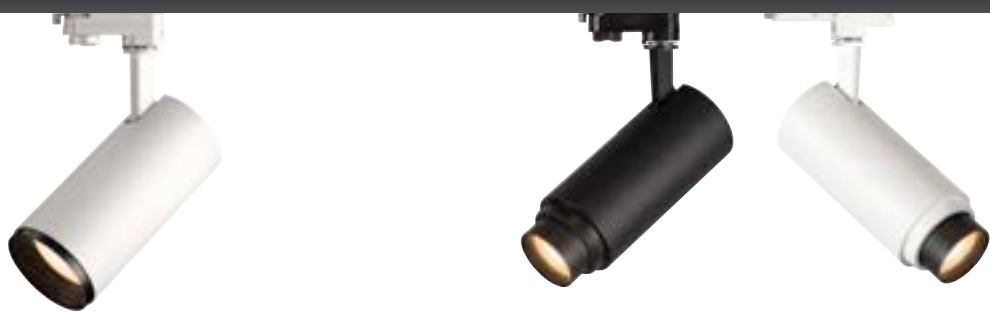

Decorative ring also available in white









Decorative ring NUMINOS® S	Diameter: 6.2 cm, H: 2 cm	○	1006167
Decorative ring NUMINOS® M	Diameter: 8.2 cm, H: 2.4 cm	○	1006168
Decorative ring NUMINOS® L	Diameter: 9.65 cm, H: 2.5 cm	○	1006169
Decorative ring NUMINOS® XL	Diameter: 11.66 cm H: 2.85 cm	○	1006170

Detailed measurements and assembly information can be found on pages 118–119



S 220-240V ~50/60Hz | 250mA
Total wattage: 11W
Material: aluminium/polycarbonate (PC)















M 220-240V ~50/60Hz | 500mA
Total wattage: 20W
Material: aluminium/polycarbonate (PC)

	2700K	24°	985lm	1004074	1925lm	1004170
		36°	985lm	1004075	1935lm	1004171
		60°	980lm	1004076	1885lm	1004172
	3000K	24°	1020lm	1004082	1955lm	1004178
		36°	1020lm	1004083	1970lm	1004179
		60°	1020lm	1004084	1880lm	1004180
	4000K	24°	1100lm	1004090	2125lm	1004186
		36°	1100lm	1004091	2120lm	1004187
		60°	1100lm	1004092	2060lm	1004188
	2700K	24°	985lm	1004362	1925lm	1004458
		36°	985lm	1004363	1935lm	1004459
		60°	980lm	1004364	1885lm	1004460
	3000K	24°	1020lm	1004370	1955lm	1004466
		36°	1020lm	1004371	1970lm	1004467
		60°	1020lm	1004372	1880lm	1004468
	4000K	24°	1100lm	1004378	2125lm	1004474
		36°	1100lm	1004379	2120lm	1004475
		60°	1100lm	1004380	2060lm	1004476
	2700K	24°	985lm	1004078	1925lm	1004174
		36°	985lm	1004079	1935lm	1004175
		60°	980lm	1004080	1885lm	1004176
	3000K	24°	1020lm	1004086	1955lm	1004182
		36°	1020lm	1004087	1970lm	1004183
		60°	1020lm	1004088	1880lm	1004184
	4000K	24°	1100lm	1004094	2125lm	1004190
		36°	1100lm	1004095	2120lm	1004191
		60°	1100lm	1004096	2060lm	1004192
	2700K	24°	985lm	1004366	1925lm	1004462
		36°	985lm	1004367	1935lm	1004463
		60°	980lm	1004368	1885lm	1004464
	3000K	24°	1020lm	1004374	1955lm	1004470
		36°	1020lm	1004375	1970lm	1004471
		60°	1020lm	1004376	1880lm	1004472
	4000K	24°	1100lm	1004382	2125lm	1004478
		36°	1100lm	1004383	2120lm	1004479
		60°	1100lm	1004384	2060lm	1004480



L 220-240V ~50/60Hz | 700mA
 Total wattage: 28W
 Material: aluminium/polycarbonate (PC)

XL 220-240V ~50/60Hz | 900mA
 Total wattage: 36W
 Material: aluminium/polycarbonate (PC)

		2700K	24°	2440lm	1004266	3290lm	1005723
			36°	2400lm	1004267	3250lm	1005724
			60°	2475lm	1004268	2980lm	1005725
		3000K	24°	2430lm	1004274	3530lm	1005729
			36°	2340lm	1004275	3490lm	1005730
			60°	2400lm	1004276	3210lm	1005731
		4000K	24°	2675lm	1004282	3800lm	1005735
			36°	2620lm	1004283	3760lm	1005736
			60°	2715lm	1004284	3460lm	1005737
		2700K	24°	2440lm	1004554	3290lm	1005795
			36°	2400lm	1004555	3250lm	1005796
			60°	2475lm	1004556	2980lm	1005797
		3000K	24°	2430lm	1004562	3530lm	1005801
			36°	2340lm	1004563	3490lm	1005802
			60°	2400lm	1004564	3210lm	1005803
		4000K	24°	2675lm	1004570	3800lm	1005807
			36°	2620lm	1004571	3760lm	1005808
			60°	2715lm	1004572	3460lm	1005809
		2700K	24°	2440lm	1004270	3290lm	1005726
			36°	2400lm	1004271	3250lm	1005727
			60°	2475lm	1004272	2980lm	1005728
		3000K	24°	2430lm	1004278	3530lm	1005732
			36°	2340lm	1004279	3490lm	1005733
			60°	2400lm	1004280	3210lm	1005734
		4000K	24°	2675lm	1004286	3800lm	1005738
			36°	2620lm	1004287	3760lm	1005739
			60°	2715lm	1004288	3460lm	1005740
		2700K	24°	2440lm	1004558	3290lm	1005798
			36°	2400lm	1004559	3250lm	1005799
			60°	2475lm	1004560	2980lm	1005800
		3000K	24°	2430lm	1004566	3530lm	1005804
			36°	2340lm	1004567	3490lm	1005805
			60°	2400lm	1004568	3210lm	1005806
		4000K	24°	2675lm	1004574	3800lm	1005810
			36°	2620lm	1004575	3760lm	1005811
			60°	2715lm	1004576	3460lm	1005812

NUMINOS® ZOOM
1006117



short. Smile while you still have tact





NUMINOS® ZOOM
3-phase track system



M 220-240V ~50/60Hz | 500mA
Total wattage: 20W
Material: aluminium/polycarbonate (PC)



		2700K	15°-60°	680-1650lm	1006108
		3000K	15°-60°	750-1800lm	1006110
		4000K	15°-60°	780-1900lm	1006112
		2700K	15°-60°	680-1650lm	1006114
		3000K	15°-60°	750-1800lm	1006116
		4000K	15°-60°	780-1900lm	1006118
		2700K	15°-60°	680-1650lm	1006109
		3000K	15°-60°	750-1800lm	1006111
		4000K	15°-60°	780-1900lm	1006113
		2700K	15°-60°	680-1650lm	1006115
		3000K	15°-60°	750-1800lm	1006117
		4000K	15°-60°	780-1900lm	1006119



Half-peak divergence
adjustable from 15°-60°

Detailed measurements and assembly information can be found on pages 118–119

CONFIGURE YOUR NUMINOS®

SELECT YOUR

SYSTEM

COLOUR

NUMINOS® DL

NUMINOS® MOVE

NUMINOS® GIMBLE

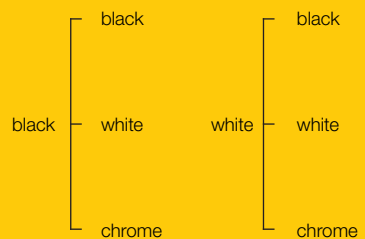

NUMINOS® PROJECTOR

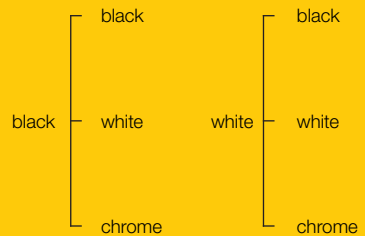

NUMINOS® PD

NUMINOS® CL

NUMINOS® SPOT



NUMINOS® TRACK

NUMINOS® ZOOM



The NUMINOS® lighting system offers constant lighting characteristics and modern design for all uses: hotels and offices to commercial and private spaces. From application to technology to detailed design: one great feature is that the modular downlights and spotlights can be configured exactly as required, depending on the design or space in question. The more multifaceted your project, the more you can benefit from the NUMINOS® lighting system.



SIZE

PERFORMANCE

DIFFUSERS

XS **S** **M** **L** **XL**

- XS** 200mA
Power consumption: 7W
- S** 250mA
Power consumption: 8.6W
- M** 500mA
Power consumption: 17.5W
- L** 700mA
Power consumption: 25.4W
- XL** 1050mA
Power consumption: 37.4W

ELLIPTICAL
Vertically distributed light, reduced glare, perfect for corridor use

PRISMATIC
Wide beam, low glare, perfect for lights at specific distances

XS **S** **M** **L**

- XS** 200 mA
Power consumption: 7W
- S** 250 mA
Power consumption: 8.6W
- M** 500 mA
Power consumption: 17.5W
- L** 700 mA
Power consumption: 25.4W

FROSTED
Wide beam, superior illumination, perfect for low ceilings

HONEYCOMB
Narrow beam, reduced glare, perfect for computer work

Matching drivers can be found on pages 94–95

S **M** **L** **XL**

- S** 250mA
Power consumption: 11W
- M** 500mA
Power consumption: 20W
- L** 700mA
Power consumption: 28W
- XL** 900mA
Power consumption: 36W

S **M** **L** **XL**

NUMINOS® Zoom only available in size M

NUMINOS® SIZES

DOWNLIGHTS

XS

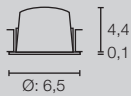

Installation dimensions:
Diameter: 5.5 cm D: 11.0 cm

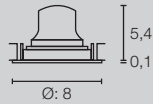

Installation dimensions:
Diameter: 6.8 cm D: 8 cm

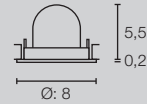

Installation dimensions:
Diameter: 6.8 cm D: 8 cm

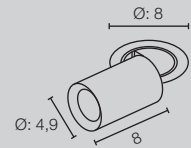

Installation dimensions:
Diameter: 6.8 cm D: 10 cm

S

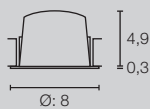

Installation dimensions:
Diameter: 6.8 cm D: 5.5 cm

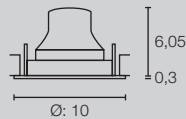

Installation dimensions:
Diameter: 9 cm D: 8.5 cm

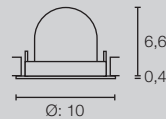

Installation dimensions:
Diameter: 9 cm D: 7 cm

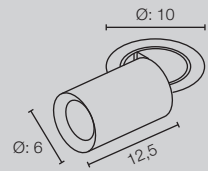

Installation dimensions:
Diameter: 8.8 cm D: 15 cm

M

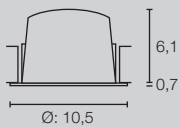

Installation dimensions:
Diameter: 9 cm D: 7.5 cm

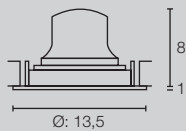

Installation dimensions:
Diameter: 12 cm D: 10 cm

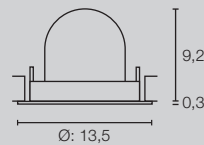

Installation dimensions:
Diameter: 12 cm D: 10 cm

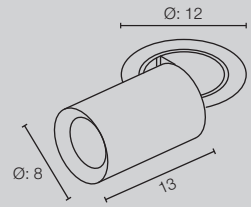

Installation dimensions:
Diameter: 10.5 cm D: 15 cm

L

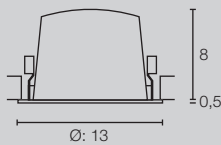

Installation dimensions:
Diameter: 11.7 cm D: 9 cm

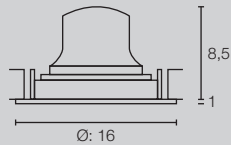

Installation dimensions:
Diameter: 14.5 cm D: 10.5 cm

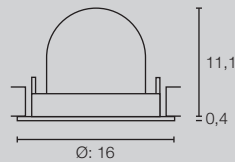

Installation dimensions:
Diameter: 14.5 cm D: 11.5 cm

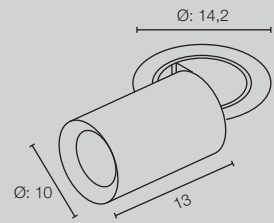

Installation dimensions:
Diameter: 13 cm D: 15 cm

XL

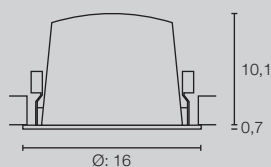

Installation dimensions:
Diameter: 14.5 cm D: 11.5 cm

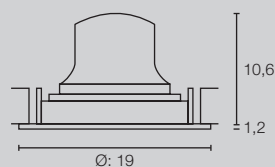

Installation dimensions:
Diameter: 17.5 cm D: 13 cm

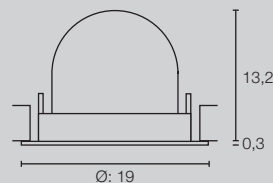

Installation dimensions:
Diameter: 17.5 cm D: 13.5 cm

**NUMINOS®
DL**

**NUMINOS®
MOVE**

**NUMINOS®
GIMBLE**

**NUMINOS®
PROJECTOR**

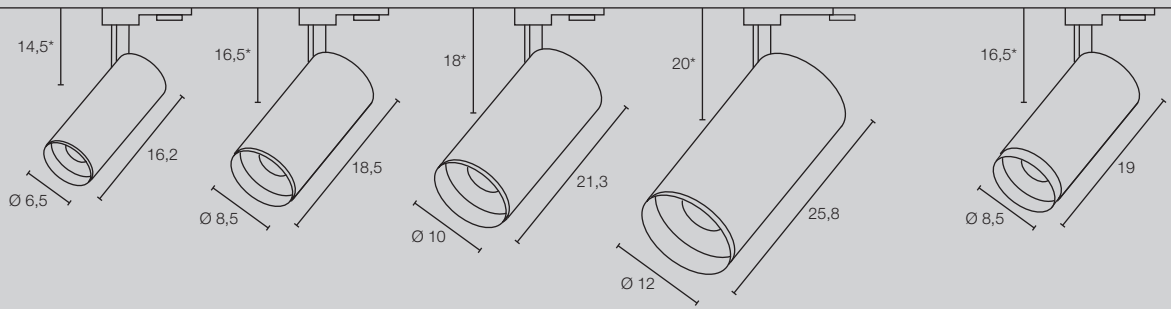
S**M****L****XL****M****NUMINOS® TRACK**

*For angles less than 90°

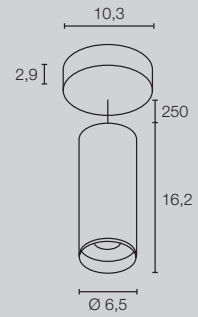
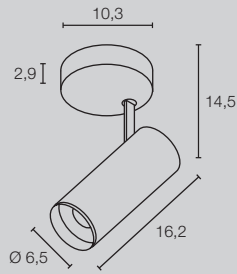
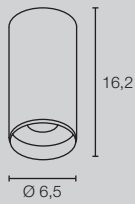
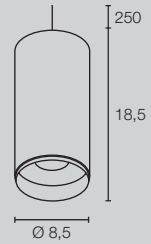
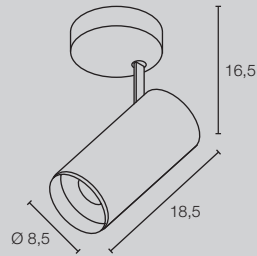
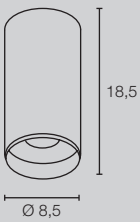
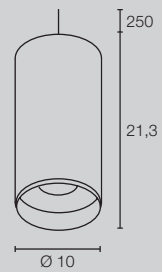
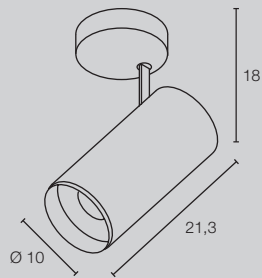
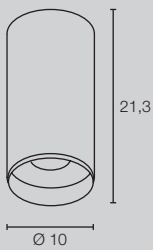
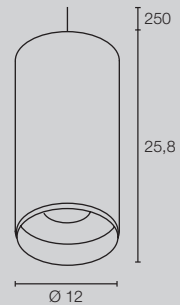
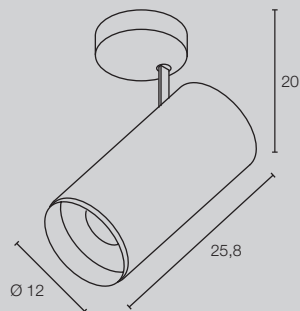
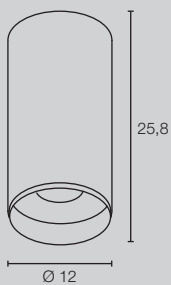
NUMINOS® ZOOM**CEILING AND WALL LIGHTS****S****M****L****XL****NUMINOS®
CL****NUMINOS®
CW****NUMINOS®
PD**

NUMINOS®

DOWN-/SPOTLIGHTS



Discover the
NUMINOS®
Configurator
at slv.com

Available in seven versions
with high-performance LED
module in three light colours
and glare ratings.

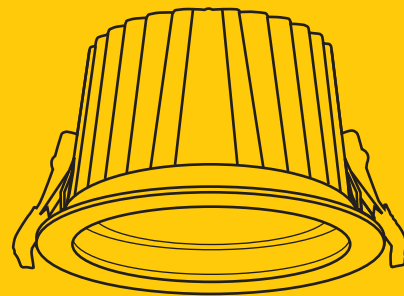

Selectable reflectors with
half beam angles of 20°-55°.

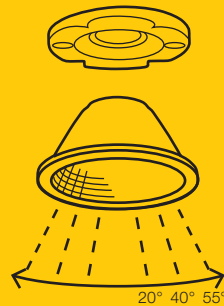

Various effect filters available
as accessories.



The decorative ring can be
selected as a visible border.



DOWNLIGHTS

NUMINOS® downlights are available as fixed or swivelling versions.

NUMINOS® ONE LIGHTING SYSTEM – A THOUSAND POSSIBILITIES. The freely configurable lighting system that casts a good light on every setting. No two projects are the same. However, many projects demand a coherent lighting and design concept. NUMINOS® is a perfectly coordinated lighting system that harmonises function, design and technology. For planners and doers. For every need. For maximum variety with minimum effort.

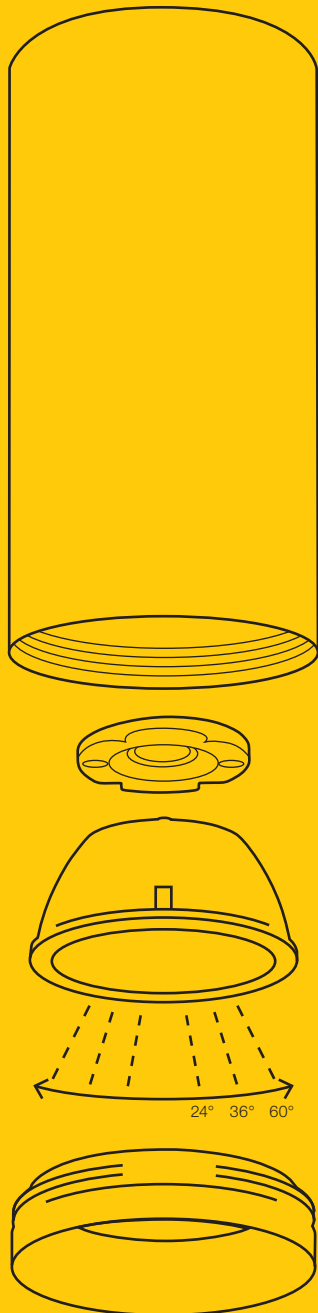

Available in three housing sizes with high-power LED module in three light colours.

Thanks to the built-in LED driver, all spotlights are suitable for direct connection to 230V mains voltage.

Choice of lenses with half beam angles of 24°-60°.

The decorative ring can be selected as a visible border.

SPOTLIGHTS

NUMINOS® spotlights are available as swivelling or fixed ceiling spots, pendant lights and as spots for 3-phase track systems.

NEW TRIA®
1007334

COMBINE



GU10 socket or LED module

+



Mounting ring available in black, white, pink gold and aluminium

=





NEW TRIA® Downlight (DL)



NEW



Modular Plug & Play system for maximum flexibility



Outstanding colour rendering index >90

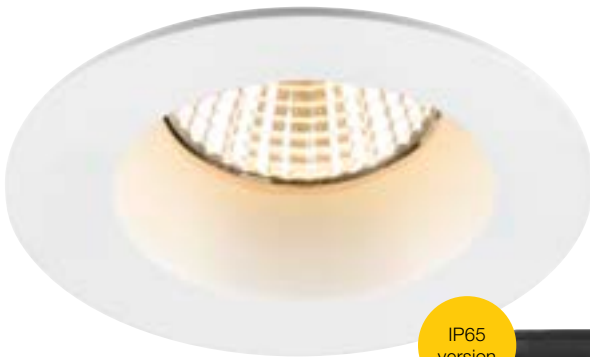

IP65
version

Easy to install thanks to Quick Connector



NEW TRIA® SETS

You'll find out top selling combined sets on pages 132 – 139

LED MODULE FOR 68 AND 75 mm RING INSTALLATION DIAMETER



NEW TRIA® DL, LED module, Phase



220-240V ~50/60Hz
Material: aluminium

	IP20	200mA	8,3W	2700K	705lm	1007381 ●
				3000K	750lm	1007383 ●



NEW TRIA® DL, LED module, Phase



220-240V ~50/60Hz
Material: aluminium

	IP20	200mA	8,3W	2700K	705lm	1007382 ●
				3000K	750lm	1007384 ●



DIM-TO-WARM MODULE FOR 68 AND 75 mm RING INSTALLATION DIAMETER

NEW TRIA® DL, LED module, DTW, Phase



220-240V ~50/60Hz
Material: aluminium

	IP20	250mA	11W	1800 - 3000K	700lm	1007421 ●
--	------	-------	-----	--------------	-------	-----------



NEW TRIA® DL, LED module, DTW, Phase



220-240V ~50/60Hz
Material: aluminium

	IP20	250mA	11W	1800 - 3000 K	700lm	1007422 ●
--	------	-------	-----	---------------	-------	-----------



DIM-TO-WARM (DTW)

The dim-to-warm feature lets you adjust the colour temperature and brightness of the light. When dimmed, the light changes from a bright, cool-white colour to a warm colour.

All Watt measurements are based on the total wattage.

Detailed measurements and assembly information can be found on pages 128–129



MULTI WATTAGE 3 CCT MODULE FOR 68 AND 75 mm RING INSTALLATION DIAMETER

NEW TRIA® UNIVERSAL DL, LED module, Phase



220-240V ~50/60Hz
Material: aluminium

● ○ IP20 100 - 180mA 4,6 - 8,6W CCT 2500 / 3000 / 4000K 540 / 600 / 600lm 1007431 ●



NEW TRIA® UNIVERSAL DL, LED module, Phase



220-240V ~50/60Hz
Material: aluminium

● ○ IP20 100 - 180mA 4,6 - 8,6W CCT 2500 / 3000 / 4000K 540 / 600 / 600lm 1007432 ●



GU10 MODULE FOR 68 AND 75 mm RING INSTALLATION DIAMETER

GU10 LED CONNECTION BOX with base



220-240V ~50/60Hz
Material: aluminium

● - IP20 - <10W - - 1007283 ●

Matching lamps can be found on page 860



LED MODULE FOR 95 mm RING INSTALLATION DIAMETER

NEW TRIA® DL, LED module, Phase



220-240V ~50/60Hz
Material: aluminium

● ○ IP20 350mA 13,3W 2700K 1130lm 1007409 ●
● ○ IP20 350mA 13,3W 3000K 1200lm 1007410 ●



NEW TRIA® DL, LED module, Phase



220-240V ~50/60Hz
Material: aluminium







● ○ IP20 350mA 13,3W 2700K 1130lm 1007411 ●
● ○ IP20 350mA 13,3W 3000K 1200lm 1007412 ●





CHOOSE A MOUNTING RING:



SUITABLE FOR ALL 68/75 INSTALLATION DIAMETER MODULE AND GU10 FITTING

NEW TRIA® 68 <i>Round ring, GU10/LED module</i>	black	IP20	Diameter: 8.2 cm, H: 2.6 cm	1007332	
	white			1007333	
	pink gold			1007334	
	aluminium			1007335	
NEW TRIA® 68 <i>Square ring, GU10/LED module</i>	black	IP20	L: 8.2 cm, W: 8.2 cm, H: 2.6 cm	1007329	
	white			1007328	
	pink gold			1007331	
	aluminium			1007330	
NEW TRIA® 68 <i>Round ring, GU10/LED module</i>	black	IP20	Diameter: 8.2 cm, H: 4.4 cm	1007451	
	white			1007453	
NEW TRIA® 68 <i>Round ring, GU10/LED module</i>	black	IP65	Diameter: 8.2 cm, H: 3.4 cm	1007345	
	white			1007346	
NEW TRIA® 68 <i>Square ring, GU10/LED module</i>	black	IP65	L: 8.2 cm, W: 8.2 cm, H: 3.4 cm	1007347	
	white			1007348	
NEW TRIA® 68 <i>Round ring, GU10/LED module with decorative glass cover</i>	black	IP65	Diameter: 8.3 cm, H: 3.6 cm	1007336	
	white			1007337	
NEW TRIA® 68 <i>Square ring, GU10/LED module with decorative glass cover</i>	black	IP65	L: 8.3 cm, W: 8.3 cm, H: 3.6 cm	1007338	
	white			1007339	
NEW TRIA® 75 <i>Round ring, GU10/LED module</i>	black	IP20	Diameter: 9.3 cm H: 2.6 cm	1007343	
	white			1007342	
	pink gold			1007344	
	aluminium			1007351	
NEW TRIA® 75 <i>Square ring, GU10/LED module</i>	black	IP20	L: 9 cm, W: 9 cm, H: 2.6 cm	1007340	
	white			1007349	
	pink gold			1007341	
	aluminium			1007350	
NEW TRIA® 75 <i>Round ring, GU10/LED module Recessed with rim</i>	black	IP20	Diameter: 8.2 cm, H: 4.9 cm	1007449	
	white			1007450	
NEW TRIA® 75 <i>Round ring, GU10/LED module Recessed</i>	black	IP20	Diameter: 8.2 cm, H: 4.3 cm	1007488	
	white			1007489	
NEW TRIA® 75 XL <i>Round ring, GU10/LED module</i>	black	IP20	Diameter: 11 cm, H: 2.6 cm	1007631	
	white			1007630	
	pink gold			1007633	
	aluminium			1007632	
NEW TRIA® 75 XL <i>Square ring, GU10/LED module</i>	black	IP20	L: 11 cm, W: 11 cm, H: 2.6 cm	1007635	
	white			1007634	
	pink gold			1007637	
	aluminium			1007636	

SUITABLE FOR ALL 95 sets MODULE INSTALLATION DIAMETER

NEW TRIA® 95 <i>Round ring, LED module</i>	black	IP20	Diameter: 11 cm, H: 2.6 cm	1007444	
	white			1007443	
	pink gold			1007447	
	aluminium			1007445	
NEW TRIA® 95 <i>Round ring, LED module</i>	black	IP20	Diameter: 10.3 cm H: 5.5 cm	1007452	
	white			1007454	
NEW TRIA® 95 <i>Square ring, LED module</i>	black	IP20	L: 11 cm, W: 11 cm, H: 2.6 cm	1007446	
	white			1007448	



With decorative glass cover



30° pivot angle

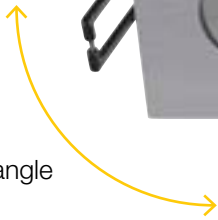

30° rotation and pivot angle



Recessed with rim



Recessed



NEW TRIA® SIZES

LED MODULE FOR 68 and 75 mm RING INSTALLATION DIAMETER

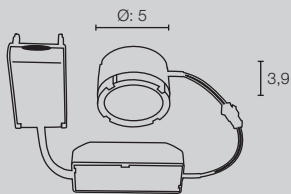

1007381 - 384

NEW TRIA®
DL, LED MODULE, PHASE

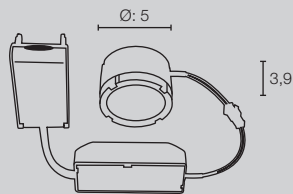

1007421 - 422

NEW TRIA®
DL, LED MODULE, DTW, PHASE

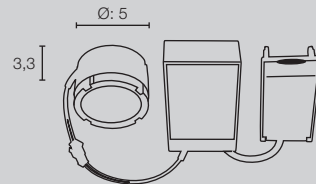

1007431 - 432

NEW TRIA® UNIVERSAL
DL, LED MODULE, PHASE

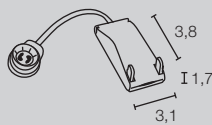

1007283

GU10 LED CONNECTION BOX
WITH BASE

LED MODULE FOR 95 mm
RING INSTALLATION DIAMETER

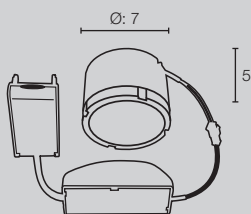

1007409, 1007410 - 412

NEW TRIA®
DL, LED MODULE, PHASE

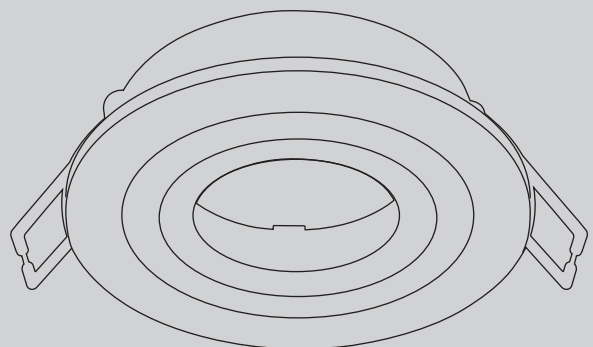
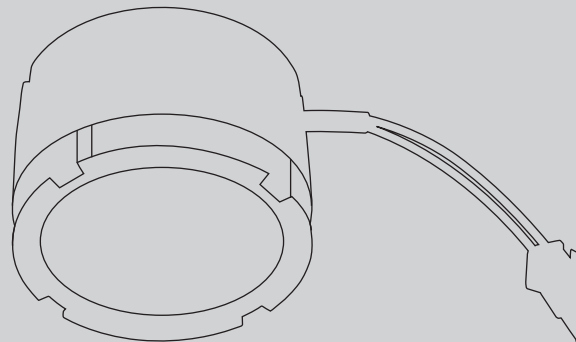

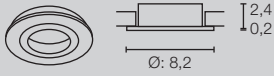

Installation dimensions:
Diameter: 6.8 cm
1007332 - 335

NEW TRIA® 68
ROUND RING, GU10/LED MODULE

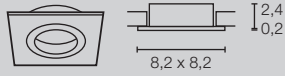

Installation dimensions:
Diameter: 6.8 cm
1007328 - 331

NEW TRIA® 68
SQUARE RING, GU10/LED MODULE

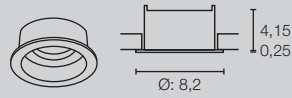

Installation dimensions:
Diameter: 6.8 cm
1007451, 1007453

NEW TRIA® 68
ROUND RING, GU10/LED MODULE

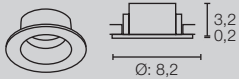

Installation dimensions:
Diameter: 6.8 cm
1007345 - 346

NEW TRIA® 68
ROUND RING, GU10/LED MODULE

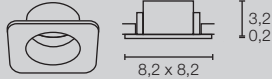

Installation dimensions:
Diameter: 6.8 cm
1007347 - 348

NEW TRIA® 68
SQUARE RING, GU10/LED MODULE

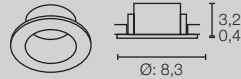

Installation dimensions:
Diameter: 6.8 cm
1007336 - 337

NEW TRIA® 68
ROUND RING, GU10/LED MODULE

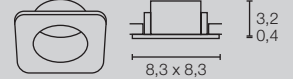

Installation dimensions:
Diameter: 6.8 cm
1007338 - 339

NEW TRIA® 68
SQUARE RING, GU10/LED MODULE



Installation dimensions:
Diameter: 7.5 cm
1007342 - 344, 1007351

NEW TRIA® 75
ROUND RING, GU10/LED MODULE

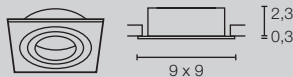

Installation dimensions:
Diameter: 7.5 cm
1007340 - 341, 1007349 - 350

NEW TRIA® 75
SQUARE RING, GU10/LED MODULE

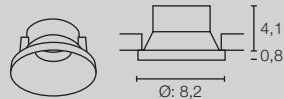

Installation dimensions:
Diameter: 7.5 cm
1007449 - 450

NEW TRIA® 75
ROUND RING, GU10/LED MODULE

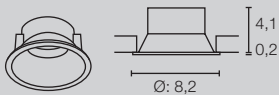

Installation dimensions:
Diameter: 7.5 cm
1007488 - 489

NEW TRIA® 75
ROUND RING, GU10/LED MODULE

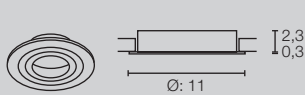

Installation dimensions:
Diameter: 7.5 cm
1007630 - 633

NEW TRIA® 75 XL
ROUND RING, GU10/LED MODULE

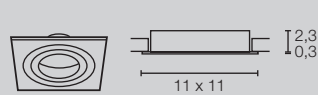

Installation dimensions:
Diameter: 7.5 cm
1007634 - 637

NEW TRIA® 75 XL
SQUARE RING, GU10/LED MODULE

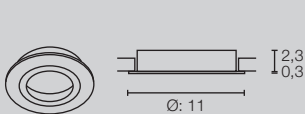

Installation dimensions:
Diameter: 9.5 cm
1007443 - 445, 1007447

NEW TRIA® 95
RING, ROUND, LED MODULE

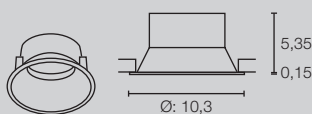

Installation dimensions:
Diameter: 9.5 cm
1007452, 1007454

NEW TRIA® 95
RING, ROUND, LED MODULE

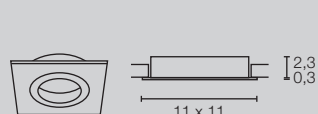

Installation dimensions:
Diameter: 9.5 cm
1007446, 1007448

NEW TRIA® 95
RING, SQUARE, LED MODULE

CONFIGURE YOUR NEW TRIA®

More modularity for greater flexibility: with the latest NEW TRIA® downlights
The series offers versatile design in a new light. Simply choose the right options
and benefit from rapid installation.

CHOOSE YOUR PREFERRED MOUNTING RING ...

- 1 Use  *pivoting, rotating and pivoting, IP65*
Diameter cutout of 68, 75 or 95 mm
- 2 Colour
black, white, pink gold or aluminium
- 3 round or square

CHOOSE YOUR PREFERRED MODULE ...

- 1 68 / 75 or 95 mm
- 2 Colour temperature
2700K or 3000K, 1800–3000K or CCT 2500 / 3000 / 4000K
- 3 Beam angle
38° / 60°

DONE!



IP20

IP65



Mounting ring



Available as a pivoting, rotating and pivoting, or IP65 version with 68, 75 or 95 mm installation diameter



Available in black, white, pink gold or aluminium



Available in round or square design

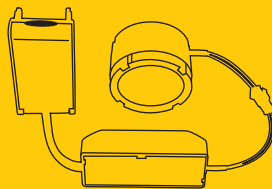

LED MODULE



GU10



NEW TRIA® 68

NEW TRIA® 75

NEW TRIA® 95



Colour temperature
2700 / 3000K, DTW 1800–3000K or multi



Beam angle
38° / 60°

NEW TRIA® 68
1007388





NEW TRIA®
Downlight (DL)



NEW

GU10
version



NEW TRIA® 75
DL, round, QPAR51



NEW TRIA® 68
DL, round, Phase

IP65
version



NEW TRIA® 68
DL, square, Phase



NEW TRIA® 75
DL, square, QPAR51

DTW
version



NEW TRIA® 68
DL, round, DTW, Phase

NEW TRIA® SETS

All NEW TRIA® Sets include perfectly matching components for fast and easy installation. Whether dim-to-warm, multi CCT or the GU10 version, you'll be optimally equipped with the NEW TRIA®.

Detailed measurements and assembly information can be found on pages 128–129

NEW

COMPLETE SETS (MOUNTING RING + LED MODULE)

NEW TRIA® 68 DL, round, Phase



220-240V ~50/60Hz
Material: aluminium

		IP20	200mA	8,3W	2700K	705lm	1007386 ●
							1007385 ●
		IP20	200mA	8,3W	3000K	750lm	1007390 ●
							1007389 ●



NEW TRIA® 68 DL, round, Phase



220-240V ~50/60Hz
Material: aluminium

		IP20	200mA	8,3W	2700K	705lm	1007388 ●
							1007387 ●
		IP20	200mA	8,3W	3000K	750lm	1007392 ●
							1007391 ●



NEW TRIA® 68 DL, square, Phase



220-240V ~50/60Hz
Material: aluminium

		IP20	200mA	8,3W	2700K	705lm	1007394 ●
							1007393 ●
		IP20	200mA	8,3W	3000K	750lm	1007398 ●
							1007397 ●



NEW TRIA® 68 DL, square, Phase



220-240V ~50/60Hz
Material: aluminium

		IP20	200mA	8,3W	2700K	705lm	1007396 ●
							1007395 ●
		IP20	200mA	8,3W	3000K	750lm	1007400 ●
							1007399 ●



All Watt measurements are based on the total wattage.

Detailed measurements and assembly information can be found on pages 146–147



NEW TRIA® 68 DL, round, Phase

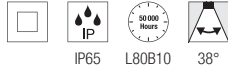

220-240V ~50/60Hz
Material: aluminium

		IP65	200mA	8,3W	2700K	460lm	1007406 ●
		IP65	200mA	8,3W	3000K	530lm	1007405 ●
		IP65	200mA	8,3W	3000K	500lm	1007408 ●
		IP65	200mA	8,3W	3000K	570lm	1007407 ●



DIM-TO-WARM



NEW TRIA® 68 DL, round, DTW, Phase



220-240V ~50/60Hz
Material: aluminium

		IP20	250mA	11W	1800 - 3000K	700lm	1007424 ●
		IP20	250mA	11W	1800 - 3000K	700lm	1007423 ●



NEW TRIA® 68 DL, round, DTW, Phase



220-240V ~50/60Hz
Material: aluminium

		IP20	250mA	11W	1800 - 3000K	700lm	1007426 ●
		IP20	250mA	11W	1800 - 3000K	700lm	1007425 ●



NEW TRIA® 68 DL, square, DTW, Phase



220-240V ~50/60Hz
Material: aluminium

		IP20	250mA	11W	1800 - 3000K	700lm	1007428 ●
		IP20	250mA	11W	1800 - 3000K	700lm	1007427 ●



NEW TRIA® 68 DL, square, DTW, Phase



220-240V ~50/60Hz
Material: aluminium

		IP20	250mA	11W	1800 - 3000K	700lm	1007430 ●
		IP20	250mA	11W	1800 - 3000K	700lm	1007429 ●





Multi CCT/Multi wattage

NEW TRIA® UNIVERSAL 68 DL, round, Phase



220-240V ~50/60Hz
Material: aluminium

  IP20 100 - 180mA 4,6 - 8,6W CCT 2500 / 3000 / 4000K 540 / 600 / 600lm

1007434 ●
1007433 ●



NEW TRIA® UNIVERSAL 68 DL, round, Phase



220-240V ~50/60Hz
Material: aluminium

  IP20 100 - 180mA 4,6 - 8,6W CCT 2500 / 3000 / 4000K 540 / 600 / 600lm

1007436 ●
1007435 ●



NEW TRIA® UNIVERSAL 68 DL, square, Phase



220-240V ~50/60Hz
Material: aluminium

  IP20 100 - 180mA 4,6 - 8,6W CCT 2500 / 3000 / 4000K 540 / 600 / 600lm

1007438 ●
1007437 ●





NEW TRIA® UNIVERSAL 68 DL, square, Phase



220-240V ~50/60Hz
Material: aluminium



IP20

100 -
180mA

4,6 - 8,6W

CCT
2500 / 3000 / 4000K

540 / 600 / 600lm

1007440 ●

1007439 ●



NEW TRIA® UNIVERSAL 68 DL, round, Phase



220-240V ~50/60Hz
Material: aluminium



IP65

100 -
180mA

4,6 - 8,6W

CCT
2500 / 3000 / 4000K

370 / 410 / 410lm

1007442 ●

430 / 470 / 470lm

1007441 ●



NEW TRIA® 75 DL, round, Phase



220-240V ~50/60Hz
Material: aluminium



IP20

200mA

8,3W

2700K

705lm

1007402 ●

1007401 ●



IP20

200mA

8,3W

3000K

750lm

1007404 ●

1007403 ●



All Watt measurements are based on the total wattage.

Detailed measurements and assembly information can be found on pages 146–147



Complete sets (mounting ring + GU10 version)

NEW TRIA® 68 DL, round, QPAR51

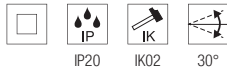

220-240V ~50/60Hz
Material: aluminium

	-	IP20	-	<10W	1xGU10	-	1007369 ●
	-	IP20	-	<10W	1xGU10	-	1007368 ●
	-	IP20	-	<10W	1xGU10	-	1007370 ●



NEW TRIA® 68 DL, square, QPAR51

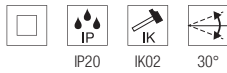

220-240V ~50/60Hz
Material: aluminium

	-	IP20	-	<10W	1xGU10	-	1007372 ●
	-	IP20	-	<10W	1xGU10	-	1007371 ●
	-	IP20	-	<10W	1xGU10	-	1007373 ●



NEW TRIA® 75 DL, round, QPAR51

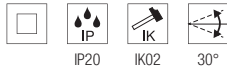

220-240V ~50/60Hz
Material: aluminium

	-	IP20	-	<10W	1xGU10	-	1007375 ●
	-	IP20	-	<10W	1xGU10	-	1007374 ●
	-	IP20	-	<10W	1xGU10	-	1007376 ●



NEW TRIA® 75 DL, square, QPAR51

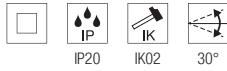

220-240V ~50/60Hz
Material: aluminium

	-	IP20	-	<10W	1xGU10	-	1007378 ●
	-	IP20	-	<10W	1xGU10	-	1007377 ●
	-	IP20	-	<10W	1xGU10	-	1007379 ●





NEW TRIA® 75 XL
DL, round, QPAR51

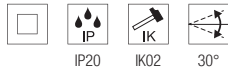

220-240V ~50/60Hz
Material: aluminium



IP20

-

<10W

1xGU10

-

1007625 ●

1007624 ●

1007626 ●



NEW TRIA® 75 XL
DL, square, QPAR51

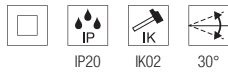

220-240V ~50/60Hz
Material: aluminium



IP20

-

<10W

1xGU10

-

1007628 ●

1007627 ●

1007629 ●



LED GU10
38°, EEK=F, 6kWh/1000h



6W

2700K

450lm

51 mm

1005077



NEW TRIA®
113890

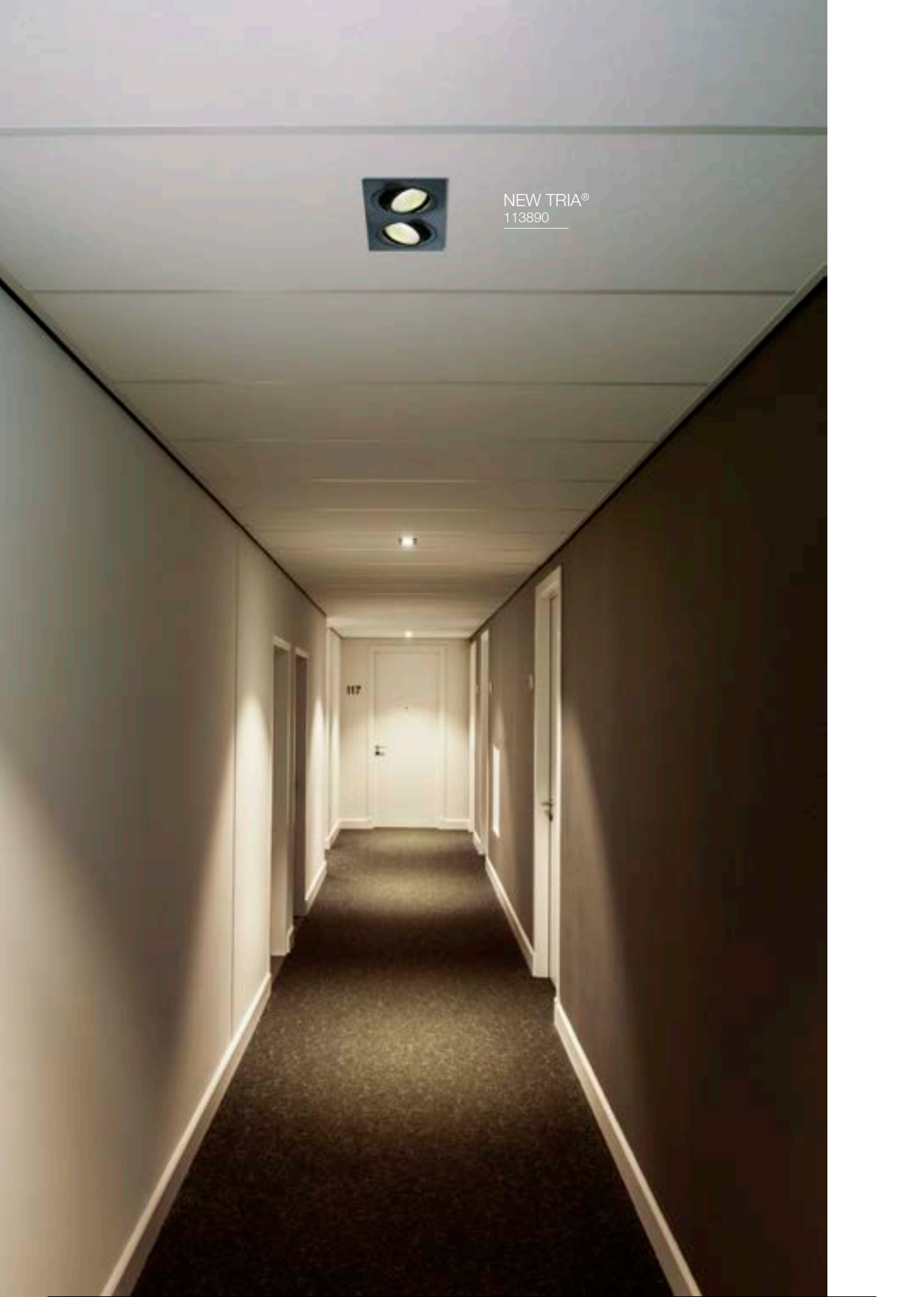



NEW TRIA®
Downlight (DL)



NEW TRIA® 155
DL, Double



NEW TRIA® 45
DL, round



NEW TRIA® 45
DL, round

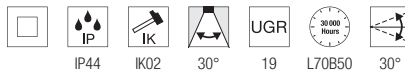

220-240V ~50/60Hz
Material: aluminium



- IP44 700mA 3,4W 3000K 190lm

113970

113971

113976



NEW TRIA® 155
DL, Double

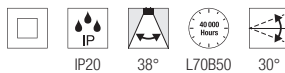

220-240V ~50/60Hz
Material: aluminium



- IP20 350mA 14W 2700K 1160lm

113890

113891



Detailed measurements and assembly information can be found on pages 146–147

NEW TRIA®
113550

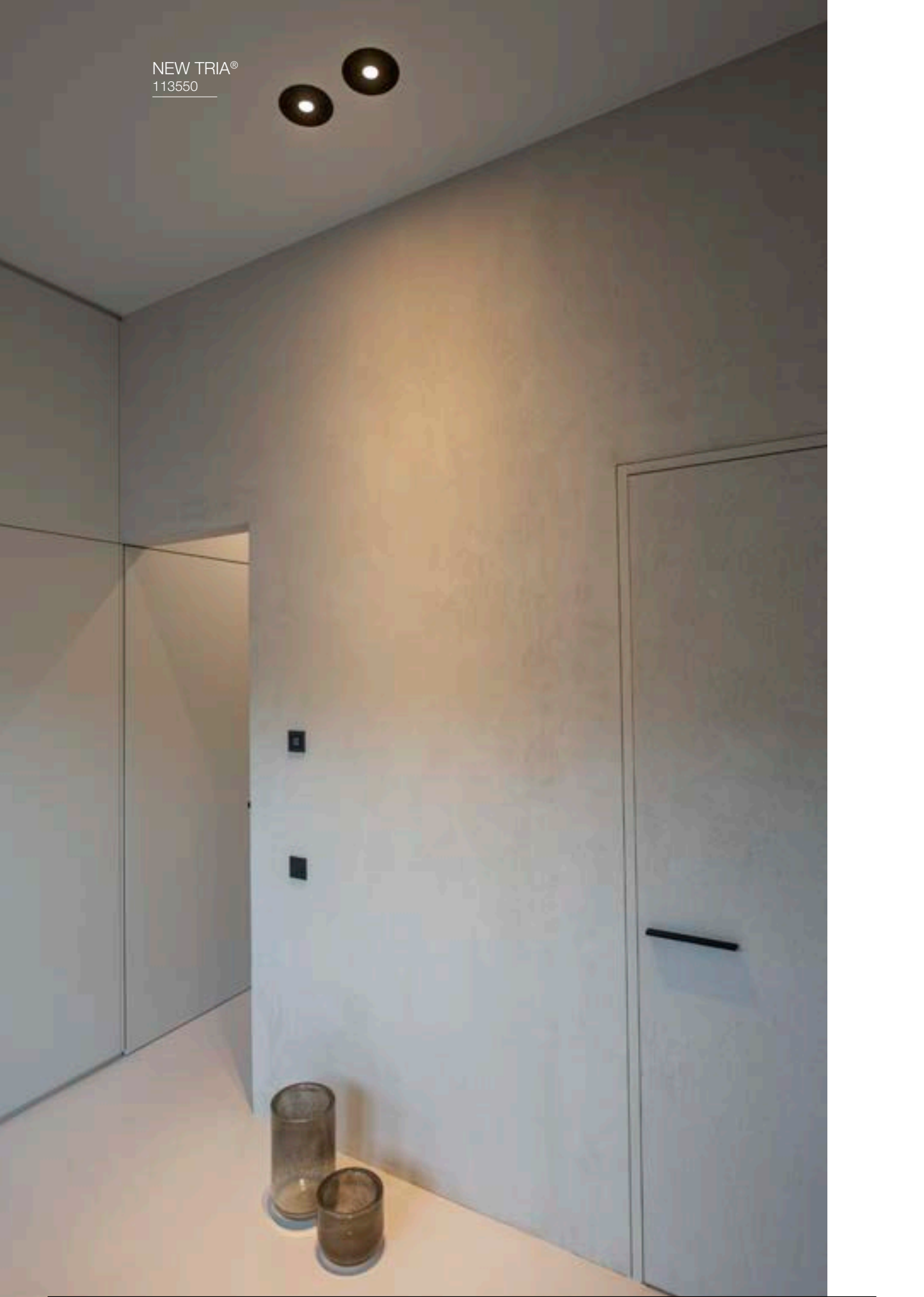



NEW TRIA® Downlight (DL)

**SOCKET
INSIDE**

NEW TRIA® 150
DL, round



NEW TRIA® 150
DL, square



NEW TRIA® 155
DL, Double



NEW TRIA® 300
DL, Double



NEW TRIA®
113840





NEW TRIA® 150
DL, round, QPAR111

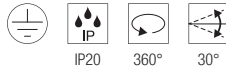

220-240V ~50/60Hz
Material: aluminium

—	-	IP20	-	<75W	1xGU10	-	113550
—							113540



NEW TRIA® 150
DL, square, QPAR111

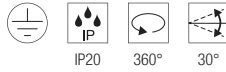

220-240V ~50/60Hz
Material: aluminium

—	-	IP20	-	<75W	1xGU10	-	113830
—							113541



NEW TRIA® 155
DL, Double, QPAR51

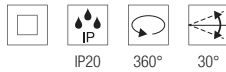

220-240V ~50/60Hz
Material: aluminium

—	-	IP20	-	<50W	2xGU10	-	113492
—							113512
—							111362



NEW TRIA® 300
DL, Double, QPAR111

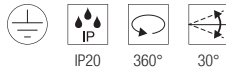

220-240V ~50/60Hz
Material: aluminium

—	-	IP20	-	<75W	2xGU10	-	113840
—							113841
—							111382



LED GU10 38°, EEK=F, 6kWh/1000h For NEW TRIA® 155		6W	2700K	450lm	51 mm	1005077
QPAR111 38°, EEK=F, 8kWh/1000h For NEW TRIA® 150/300		8W	2700K	680lm	-	1005274
LED GU10 40°, EEK=G, 8kWh/1000h For NEW TRIA® 150/300		7,3W	2700K	500lm	111 mm	1005294
QPAR111 30°, EEK=F, 13kWh/1000h For NEW TRIA® 150/300		12,5W	2700K	950lm	-	1005276

NEW TRIA[®] SIZES

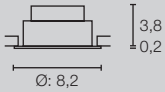

Installation dimensions:
Diameter: 6.8 cm D: 4 cm

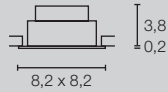

Installation dimensions:
Diameter: 6.8 cm D: 4 cm

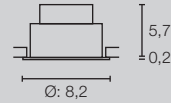

Installation dimensions:
Diameter: 6.8 cm D: 6 cm

IP65
version

NEW TRIA[®] 68 DL, ROUND, PHASE

NEW TRIA[®] 68 DL, SQUARE, PHASE

NEW TRIA[®] 68 DL, ROUND, PHASE

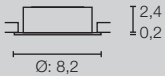

Installation dimensions:
Diameter: 6.8 cm D: 6.5 cm

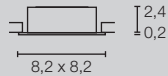

Installation dimensions:
Diameter: 6.8 cm D: 6.5 cm

NEW TRIA[®] 68 DL, ROUND, QPAR51

NEW TRIA[®] 68 DL, SQUARE, QPAR51

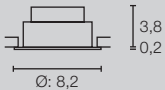

Installation dimensions:
Diameter: 6.8 cm D: 4.5 cm

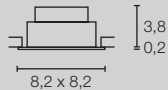

Installation dimensions:
Diameter: 6.8 cm D: 4.5 cm

NEW TRIA[®] 68 DL, ROUND, DTW, PHASE

NEW TRIA[®] 68 DL, SQUARE, DTW, PHASE

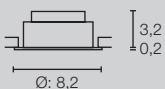

Installation dimensions:
Diameter: 6.8 cm D: 4 cm

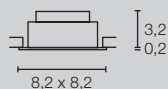

Installation dimensions:
Diameter: 6.8 cm D: 4 cm

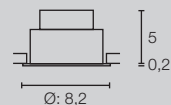

Installation dimensions:
Diameter: 6.8 cm D: 5.5 cm

IP65
version

NEW TRIA[®] UNIVERSAL 68 DL, ROUND, PHASE

NEW TRIA[®] UNIVERSAL 68 DL, SQUARE, PHASE

NEW TRIA[®] UNIVERSAL 68 DL, ROUND, PHASE

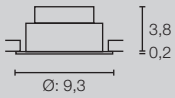

Installation dimensions:
Diameter: 7.5 cm T: 4 cm

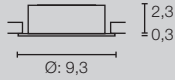

Installation dimensions:
Diameter: 7.5 cm D: 6.5 cm

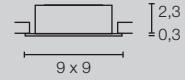

Installation dimensions:
Diameter: 7.5 cm D: 6.5 cm

NEW TRIA® 75

DL, ROUND, PHASE

NEW TRIA® 75

DL, ROUND, QPAR51

NEW TRIA® 75

DL, SQUARE, QPAR51

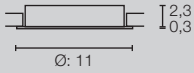

Installation dimensions:
Diameter: 7.5 cm D: 6.5 cm

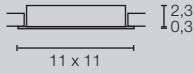

Installation dimensions:
Diameter: 7.5 cm D: 6.5 cm

NEW TRIA® 75 XL

DL, ROUND, QPAR51

NEW TRIA® 75 XL

DL, SQUARE, QPAR51

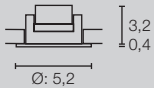

Installation dimensions:
Diameter: 4.5 cm D: 4 cm

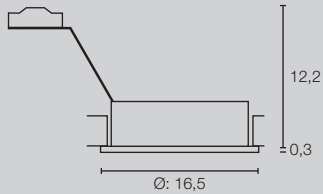

Installation dimensions:
Diameter: 15 cm D: 12.5 cm

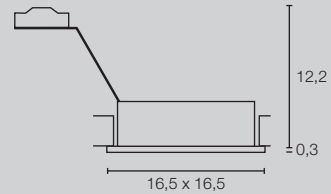

Installation dimensions:
Diameter: 15 cm D: 12.5 cm

NEW TRIA® 45

DL, ROUND

NEW TRIA® 150

DL, ROUND, QPAR111

NEW TRIA® 150

DL, SQUARE, QPAR111

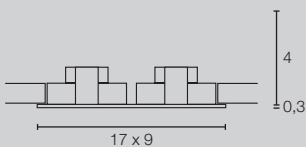

Installation dimensions:
L: 15.5, W: 8 cm D: 4 cm

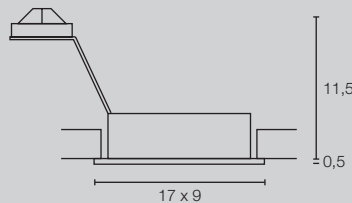

Installation dimensions:
L: 15 cm, W: 7.8 cm, D: 12.5 cm

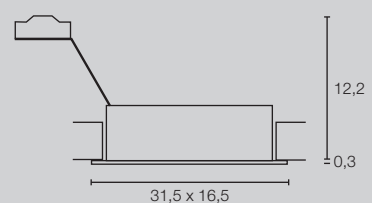

Installation dimensions:
L: 30 cm, W: 15.5 cm, D: 12.5 cm

NEW TRIA® 155

DL, DOUBLE

NEW TRIA® 155

DL, DOUBLE, QPAR51

NEW TRIA® 300

DL, DOUBLE, QPAR111

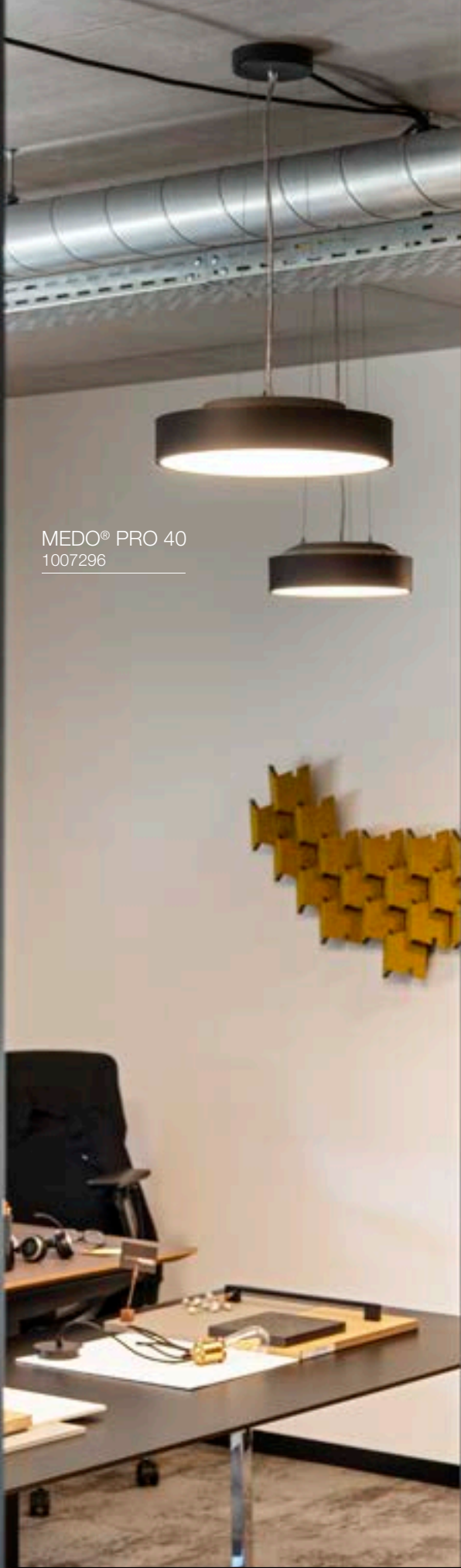

MEDO® PRO 40
1007296

Discover the entire
MEDO® family



MEDO® PRO CW



MEDO® PRO (DC) CW



MEDO® CW



MEDO® CL



MEDO® RING PD



MEDO® EL



MEDO® PRO Wall and ceiling lights (CW)



NEW

Suspension kit not included

Also available in prismatic design and particularly glare-free with UGR<19

Outstanding colour rendering index CRI>90

Colour temperature selection via CCT switch (3000/4000K)

The transparent rear diffuses light more indirectly



Easy and fast to install thanks to EasyBase

ATMOSPHERIC LIGHTING

The new MEDO® options let the background radiate too thanks to their indirect light dispersion. This creates a pleasant, even and glare-free lighting in your rooms.

PRISMATIC DESIGN (UGR<19)

MEDO® PRO 30 CW, DALI, UGR<19



220-240V ~50/60Hz
Material: aluminium/polystyrene (PS)

		IP50	250mA	10W	CCT 3000 / 4000K	1250 / 1250lm	1007284 ●
							1007285 ●



MEDO® PRO 30 CW, Phase, UGR<19



220-240V ~50/60Hz
Material: aluminium/polystyrene (PS)

		IP50	250mA	10W	CCT 3000 / 4000K	1250 / 1250lm	1007288 ●
							1007289 ●



MEDO® PRO 40 CW, DALI, UGR<19



220-240V ~50/60Hz
Material: aluminium/polystyrene (PS)

		IP50	500mA	19W	CCT 3000 / 4000K	2400 / 2500lm	1007292 ●
							1007293 ●



MEDO® PRO 40 CW, Phase, UGR<19



220-240 V ~50/60Hz
Material: aluminium/polystyrene (PS)

		IP50	500mA	19W	CCT 3000 / 4000K	2400 / 2500lm	1007296 ●
							1007297 ●





MEDO® PRO 60
CW, DALI, UGR<19



220-240V ~50/60Hz
Material: aluminium/polystyrene (PS)

		IP50	1000mA	39W	CCT 3000 / 4000K	5000 / 5100lm	1007300 ●
							1007301 ●



MEDO® PRO 60
CW, Phase, UGR<19



220-240V ~50/60Hz
Material: aluminium/polystyrene (PS)

		IP50	1000mA	37W	CCT 3000 / 4000K	5000 / 5100lm	1007304 ●
							1007305 ●



MEDO® PRO 90
CL, DALI, UGR<19



220-240V ~50/60Hz
Material: aluminium/polystyrene (PS)

		IP50	1000mA	75W	CCT 3000 / 4000K	9400 / 9700lm	1007308 ●
							1007309 ●



MEDO® PRO 90
CL, Phase, UGR<19



220-240V ~50/60Hz
Material: aluminium/polystyrene (PS)

		IP50	1000mA	74W	CCT 3000 / 4000K	9400 / 9700lm	1007312 ●
							1007313 ●



OPAL DESIGN (UGR<25)

MEDO® PRO 30 CW, DALI



220-240V ~50/60Hz
Material: aluminium/polystyrene (PS)

		IP50	250mA	10W	CCT 3000 / 4000K	1350 / 1350lm	1007286 ●
							1007287 ●



MEDO® PRO 30 CW, Phase



220-240V ~50/60Hz
Material: aluminium/polystyrene (PS)

		IP50	250mA	10W	CCT 3000 / 4000K	1350 / 1350lm	1007290 ●
							1007291 ●



MEDO® PRO 40 CW, DALI



220-240V ~50/60Hz
Material: aluminium/polystyrene (PS)

		IP50	500mA	19W	CCT 3000 / 4000K	2650 / 2650lm	1007294 ●
							1007295 ●



MEDO® PRO 40 CW, Phase



220-240V ~50/60Hz
Material: aluminium/polystyrene (PS)

		IP50	500mA	19W	CCT 3000 / 4000K	2650 / 2650lm	1007298 ●
							1007299 ●





MEDO® PRO 60 CW, DALI



220-240V ~50/60Hz
Material: aluminium/polystyrene (PS)

		IP50	1000mA	39W	CCT 3000 / 4000K	5450 / 5500lm	1007302 ●
							1007303 ●



MEDO® PRO 60 CW, Phase



220-240V ~50/60Hz
Material: aluminium/polystyrene (PS)

		IP50	1000mA	37W	CCT 3000 / 4000K	5450 / 5500lm	1007306 ●
							1007307 ●



MEDO® PRO 90 CL, DALI



220-240V ~50/60Hz
Material: aluminium/polystyrene (PS)

		IP50	1000mA	75W	CCT 3000 / 4000K	11000 / 11200lm	1007310 ●
							1007311 ●



MEDO® PRO 90 CL, Phase



220-240V ~50/60Hz
Material: aluminium/polystyrene (PS)

		IP50	1000mA	74W	CCT 3000 / 4000K	11000 / 11200lm	1007314 ●
							1007315 ●



Suspension kit 1.5 m	black	135250
	white	135251
	grey	135254
Suspension kit 5 m	black	1001952
	white	1001950
	grey	1001951

MEDO® PRO 60
1006417 (DC)

MEDO® PRO 40
1006414 (DC)



ATMOSPHERIC LIGHTING

The new MEDO® options let the background radiate too thanks to their indirect light dispersion. This creates a pleasant, even and glare-free lighting in your rooms.



MEDO® PRO

Wall and ceiling lights (CW), DC



NEW

Suspension kit not included



Easy and fast
to install thanks
to EasyBase



With prismatic design
and particularly glare-free
with UGR<19

The transparent rear
diffuses light
more indirectly

Outstanding colour
rendering index CRI>90



EMERGENCY LIGHTING

MEDO PRO DC® lets you benefit from all the technical advantages of the prismatic MEDO® PRO version with UGR<19. Thanks to the integrated, DC-compatible driver, you can rest assured that your lights will still function and guide the way during a power outage.

MEDO® PRO 60
1006417 (DC)

MEDO® PRO 30
1006411 (DC)



Find more
inspiration in
our MEDO®
brochure



MEDO® PRO 30 CW, DALI, UGR<19, DC



220-240V ~50/60Hz
Material: aluminium/polystyrene (PS)



		IP50	250mA	10W	CCT 3000 / 4000K	1250 / 1250lm	1006411 ●
							1006412 ●

MEDO® PRO 40 CW, DALI, UGR<19, DC



220-240V ~50/60Hz
Material: aluminium/polystyrene (PS)



		IP50	500mA	19W	CCT 3000 / 4000K	2400 / 2500lm	1006414 ●
							1006415 ●

MEDO® PRO 60 CW, DALI, UGR<19, DC



220-240V ~50/60Hz
Material: aluminium/polystyrene (PS)



		IP50	1000mA	37W	CCT 3000 / 4000K	5000 / 5100lm	1006417 ●
							1006418 ●

MEDO® PRO 90 CL, DALI, UGR<19, DC



220-240V ~50/60Hz
Material: aluminium/polystyrene (PS)



		IP50	1000mA	75W	CCT 3000 / 4000K	9400 / 9700lm	1006420 ●
							1006421 ●



	black	135250
Suspension kit 1.5 m	white	135251
	grey	135254
	black	1001952
Suspension kit 5m	white	1001950
	grey	1001951

MEDO® 60
1007322

MEDO® 90
1007325



ATMOSPHERIC LIGHTING

The new MEDO® options let the background radiate too thanks to their indirect light dispersion. This creates a pleasant, even and glare-free lighting in your rooms.



MEDO®
Wall and ceiling lights (CW)



NEW

Suspension kit not included

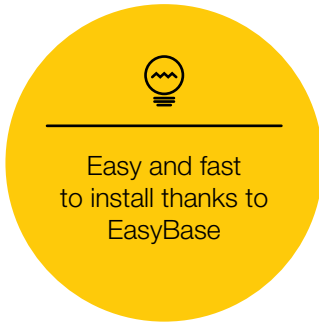

Outstanding colour rendering index CRI>90

Colour temperature selection via CCT switch (2700/3000/4000K)

The transparent rear diffuses light more indirectly



MEDO® 30
1007317





MEDO® 30 CW, Phase



220-240V ~50/60Hz
Material: aluminium/polystyrene (PS)



IP50 250mA 12W CCT 2700 / 3000 / 4000K 1050 / 1100 / 1200lm

1007316 ●
1007317 ●
1007318 ●



MEDO® 40 CW, Phase



220-240V ~50/60Hz
Material: aluminium/polystyrene (PS)



IP50 500mA 20W CCT 2700 / 3000 / 4000K 2100 / 2200 / 2350lm

1007319 ●
1007320 ●
1007321 ●



MEDO® 60 CW, Phase



220-240V ~50/60Hz
Material: aluminium/polystyrene (PS)



IP50 1000mA 39W CCT 2700 / 3000 / 4000K 4050 / 4250 / 4550lm

1007322 ●
1007323 ●
1007324 ●



MEDO® 90 CL, Phase



220-240V ~50/60Hz
Material: aluminium/polystyrene (PS)



IP50 1000mA 79W CCT 2700 / 3000 / 4000K 8300 / 8700 / 9350m

1007325 ●
1007326 ●
1007327 ●



Suspension kit 1.5 m	black	135250
	white	135251
	grey	135254
Suspension kit 5 m	black	1001952
	white	1001950
	grey	1001951

MEDO®:

HOW TO INSTALL

The new MEDO® versions are all easy and quick to install thanks to our EasyBase. Use the EasyBase directly as a template for your drill holes and wire it straight after fixing in place. Next, simply select the colour temperature using the CCT switch on the light, look for the green markings and easily click the light into place.

CEILING LIGHTS



Screw EasyBase to the ceiling

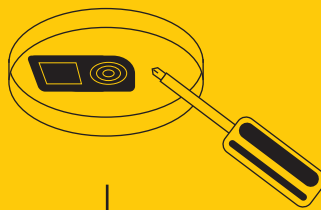

Wire EasyBase



Select the colour temperature using the CCT switch on the light, look for the green markings

MEDO® 60 and MEDO® 90 are also attached using the safety chain provided

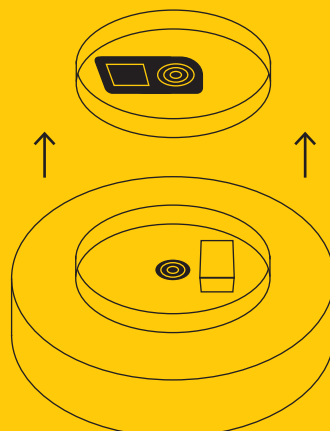

RECESSED LIGHTS
FRAMELESS

RECESSED LIGHTS
MOUNTING FRAME

Place recessed fixing kit in the ceiling

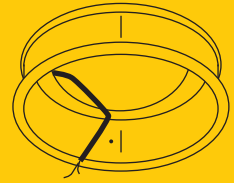
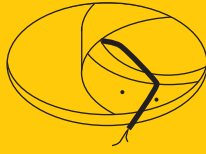

Position and secure mounting plates

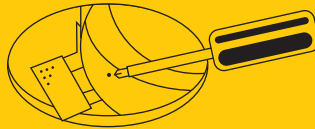

Screw mounting plate to the ceiling
and fill in the ceiling

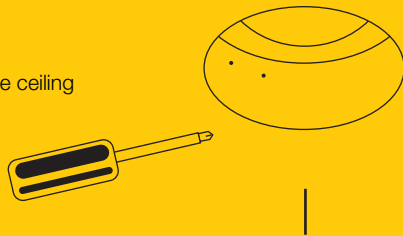

Connect LED driver

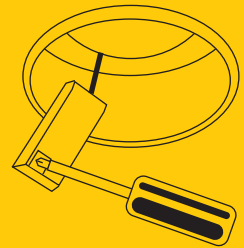
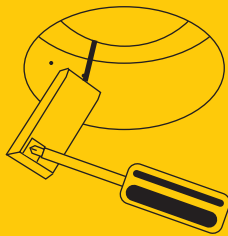

Insert LED module and select colour
temperature via the CCT switch

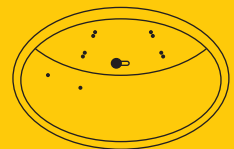

Replace cover

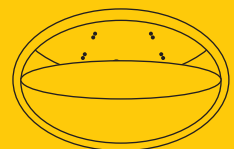

MEDO® 60
1002882

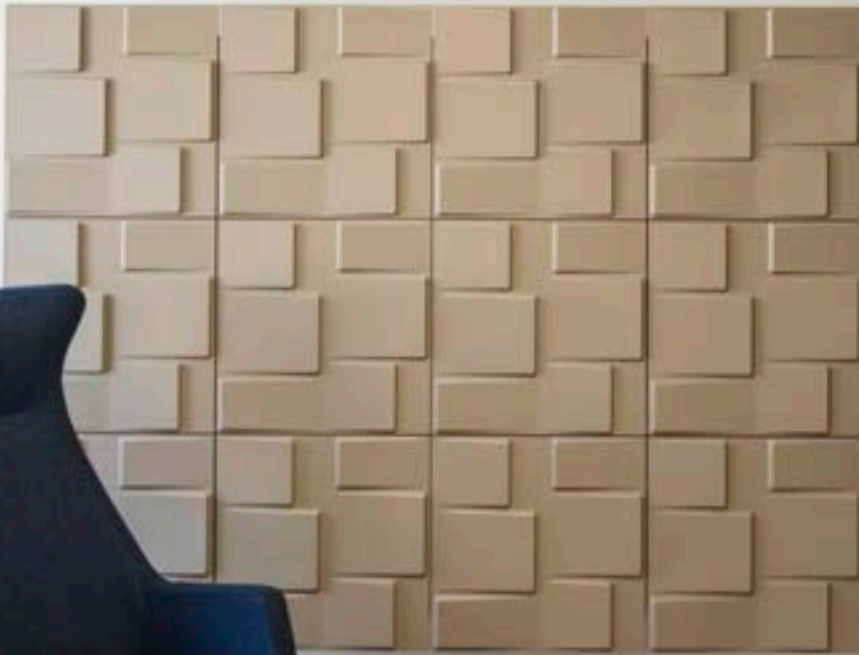



MEDO®
Ceiling lights (CL)



Suspension kit not included

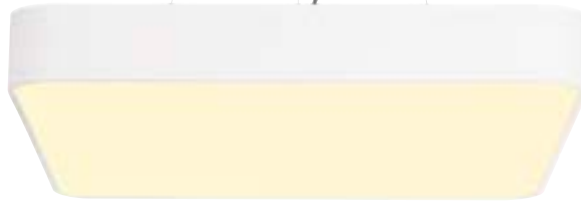

MEDO® 60
CL, Square, 1-10V



220-240V ~50/60Hz
Material: aluminium/acrylic

IP20 1000mA 39W 3000K 3800lm **1000726**

MEDO® 60
CL, Square, DALI



220-240V ~50/60Hz
Material: aluminium/acrylic

IP20 1000mA 39W 3000K 3800lm **1002882**

⊕	Suspension kit 1.5 m	black	135250
		white	135251
		grey	135254
⊕	Suspension kit 5 m	black	1001952
		white	1001950
		grey	1001951

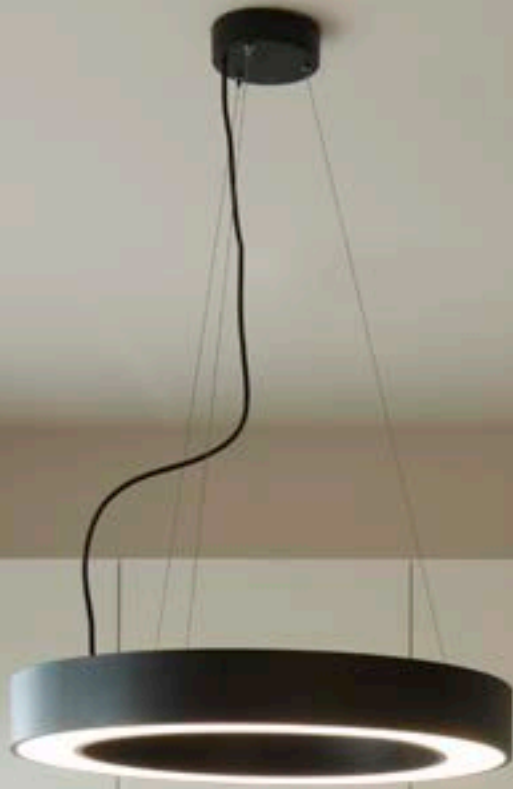

MEDO® RING 60
133840



MEDO® RING Pendant lights (PD)



MEDO® RING
in sizes 60 and 90



MEDO® RING 60 PD, 1-10V

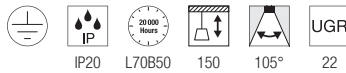

220-240V ~50/60Hz
Material: aluminium/polymethylacrylate (PMMA)

		IP20	700mA	33W	3000K	2200lm	133840	
							133841	

MEDO® RING 90 PD, 1-10V

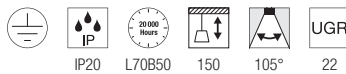

220-240V ~50/60Hz
Material: aluminium/polymethylacrylate (PMMA)

		IP20	1200mA	56W	3000K	4900lm	133850	
							133851	

MEDO® RING 60 PD, DALI

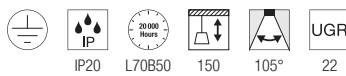

220-240V ~50/60Hz
Material: aluminium/polymethylacrylate (PMMA)

		IP20	700mA	34W	3000K	2200lm	1002890	
							1002891	

MEDO® 60
1001907

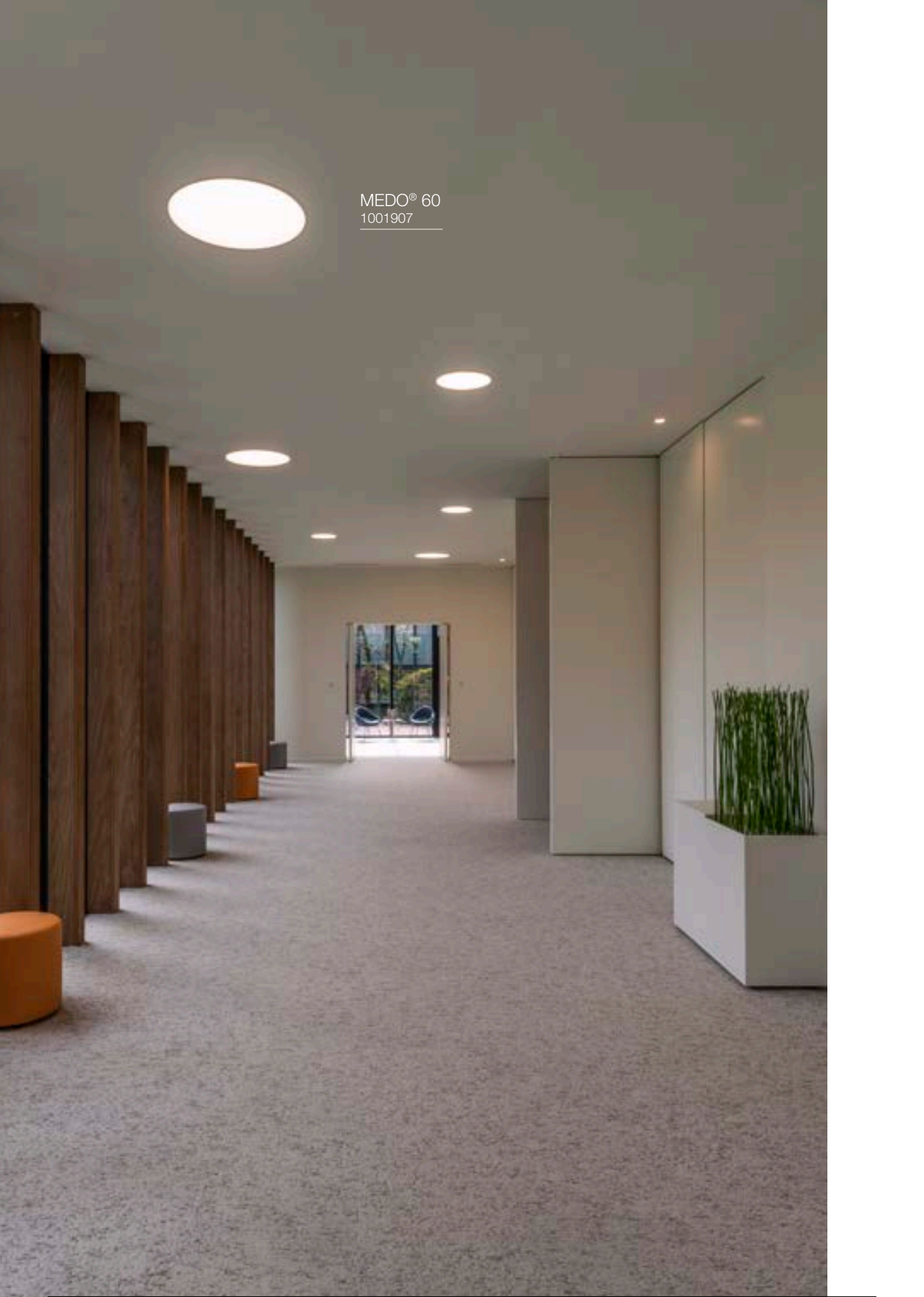



MEDO®
Recessed lights (EL)



MEDO® 30, 40 and 60
RL, frameless

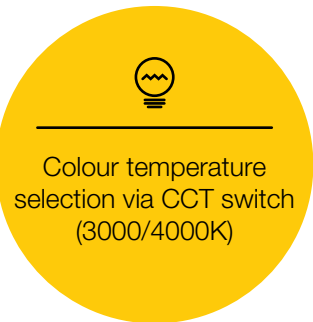

MEDO® 30, 40 and 60
RL, mounting frame



FRAMELESS

MEDO® 30 EL, Frameless

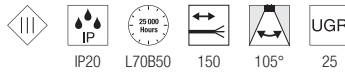

Material: aluminium/polymethylacrylate (PMMA)

○ - IP20 350mA 14W CCT 3000 / 4000K 1500 / 1600lm **1001901**



MEDO® 40 EL, Frameless

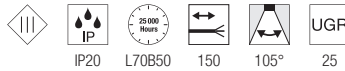

Material: aluminium/polymethylacrylate (PMMA)

○ - IP20 700mA 28W CCT 3000 / 4000K 3100 / 3300lm **1001902**



MEDO® 60 EL, Frameless



Material: aluminium/polymethylacrylate (PMMA)

○ - IP20 1000 / 1050mA 36W CCT 3000 / 4000K 4700 / 5000lm **1001903**



LED drivers are not included and must be ordered separately.
You can find suitable drivers here:





MOUNTING FRAME

MEDO® 30 EL, Mounting frame



Material: aluminium/polymethylacrylate (PMMA)

○ - IP20 350mA 14W CCT 3000 / 4000K 1500 / 1600lm **1001905**



MEDO® 40 EL, Mounting frame



Material: aluminium/polymethylacrylate (PMMA)

○ - IP20 700mA 28W CCT 3000 / 4000K 3100 / 3300lm **1001906**



MEDO® 60 EL, Mounting frame

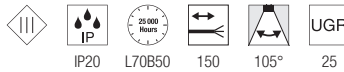

Material: aluminium/polymethylacrylate (PMMA)

○ - IP20 1000 / 1050mA 38W CCT 3000 / 4000K 4700 / 5000lm **1001907**



LED DRIVER



LED DRIVER 250-700mA, 1-10V / DALI INCLUDING STRAIN RELIEF MEDO® 30 + 60	white	20W	1-10V / DALI		L: 15 cm, W: 5.2 cm, H: 2.8 cm	1002423
LED DRIVER 500-1050mA, 1-10V / DALI INCLUDING STRAIN RELIEF MEDO® 40	white	40W	1-10V / DALI		L: 14.2 cm, W: 4.4 cm, H: 3 cm	1002424
LED DRIVER 700mA INCLUDING STRAIN RELIEF MEDO® 40	white	40W	C	-	L: 14.5 cm, W: 4 cm, H: 3 cm	1005446
LED DRIVER 1050mA INCLUDING STRAIN RELIEF MEDO® 30 + 60	white	40W	C		L: 16.6 cm W: 5.2 cm H: 2.4 cm	464804
LED DRIVER 700 / 900 / 1000mA INCLUDING STRAIN RELIEF MEDO® 30 + 40 + 60	white	40W	-		L: 12.3 cm, W: 7.9 cm, H: 3 cm	1006120

MEDO® OVERVIEW



MEDO® PRO
CW

MEDO® PRO (DC)
CW

MEDO®
CW

Sizes	30 40 60 90	30 40 60 90	30 40 60 90
Suspension kit	1.5 5 m (not included)	1.5 5 m (not included)	1.5 5 m (not included)
EasyBase	✓	✓	✓
CCT switch	✓	✓	✓
DALI	✓	✓	-
Phase	C	-	C
1-10V	-	-	-
UGR	19 25	19	22 25
DC	-	✓	-

LED drivers are not included
and must be ordered separately

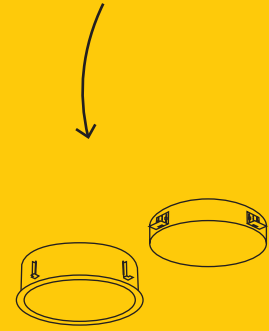
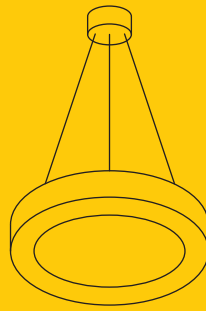

MEDO®
CL, SQUARE

MEDO® RING
PD

MEDO®
EL, FRAMELESS | MOUNTING FRAME

	60	60	30 40 60
	1.5 5 m (not included)	1.5 m (included)	-
	-	-	-
	-	-	✓
	✓	✓	✓*
	-	-	✓*
	✓	✓	✓*
	22	22	25
	-	-	-

*Requires driver

MEDO® SIZES

RECESSED LIGHTS

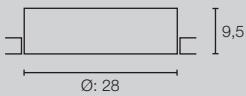

Installation dimensions:
Diameter: 29 cm D: 13 cm

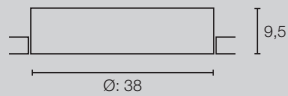

Installation dimensions:
Diameter: 39 cm D: 13 cm

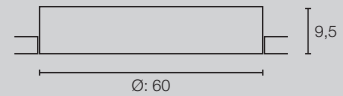

Installation dimensions:
Diameter: 61 cm D: 16 cm

MEDO® 30
EL, FRAMELESS

MEDO® 40
EL, FRAMELESS

MEDO® 60
EL, FRAMELESS

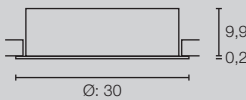

Installation dimensions:
Diameter: 29 cm D: 13 cm

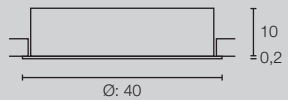

Installation dimensions:
Diameter: 39 cm D: 13 cm

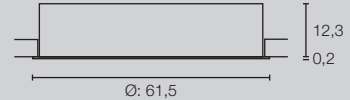

Installation dimensions:
Diameter: 61 cm D: 16 cm

MEDO® 30
EL, MOUNTING FRAME

MEDO® 40
EL, MOUNTING FRAME

MEDO® 60
EL, MOUNTING FRAME

CEILING LIGHT

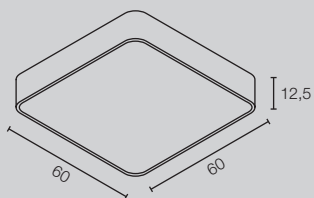

MEDO® 60
CL, SQUARE

PENDANT LIGHTS

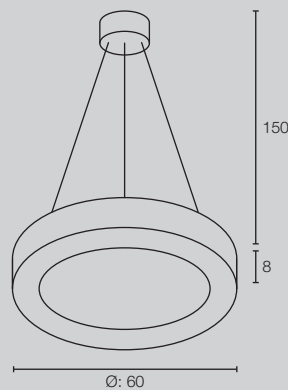

MEDO® RING 60
PD

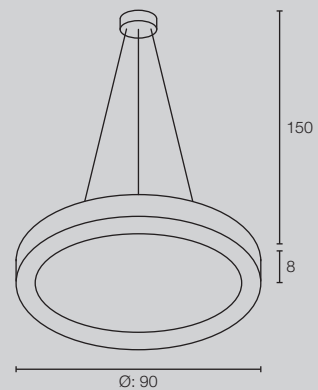

MEDO® RING 90
PD



All ceiling lights
can also be used as
pendant lights

WALL AND CEILING LIGHTS

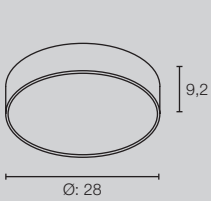

MEDO® PRO 30
CW, DC

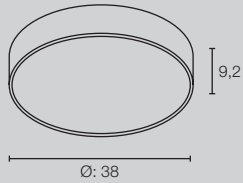

MEDO® PRO 40
CW, DC

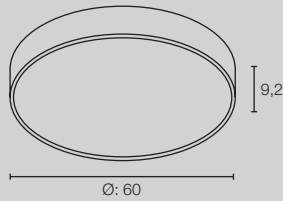

MEDO® PRO 60
CW, DC

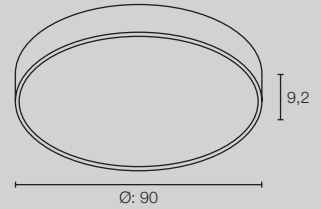

MEDO® PRO 90
CL, DC

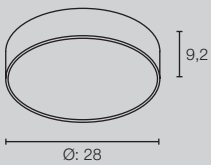

MEDO® PRO 30
CW

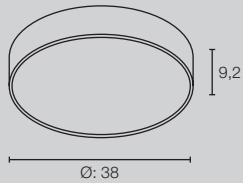

MEDO® PRO 40
CW

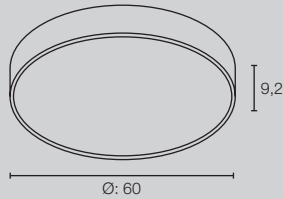

MEDO® PRO 60
CW

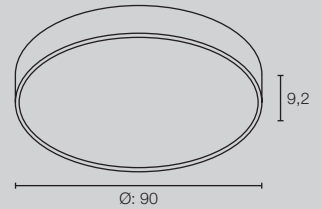

MEDO® PRO 90
CL

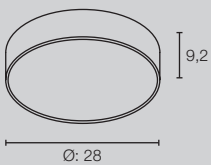

MEDO® 30
CW

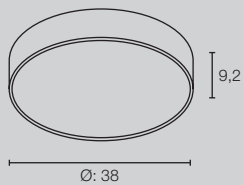

MEDO® 40
CW

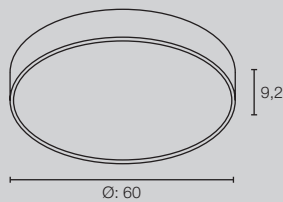

MEDO® 60
CW

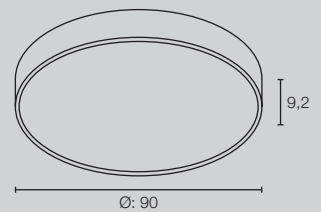

MEDO® 90
CL

LALU®
1007550





LALU®
Pendant lights (PD)

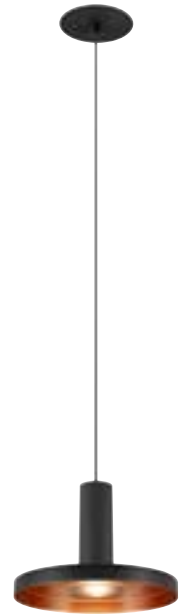
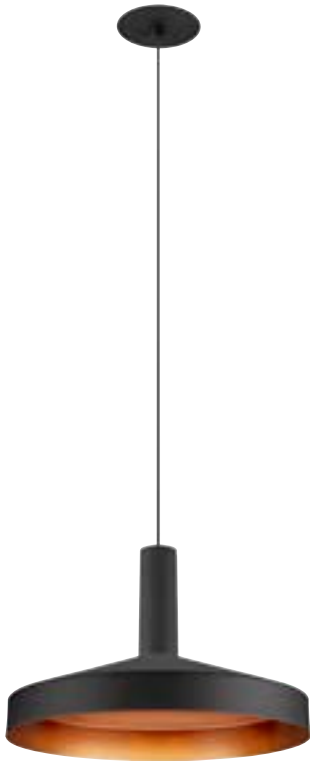

Combine the colours and shapes of the LALU® Pendant lights

LALU®
PD, LED Base, Phase



220-240V ~50/60Hz
Material: aluminium/steel

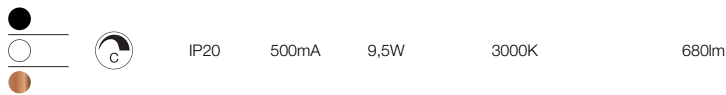

- 1007518 ●
- 1007519 ●
- 1007520 ●



LALU®
PD, LED Base, Phase, Recessed



220-240V ~50/60Hz
Material: aluminium/steel

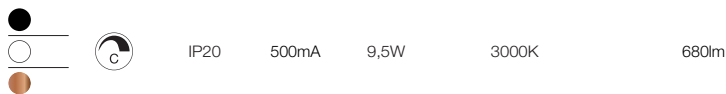

- 1007548 ●
- 1007549 ●
- 1007550 ●



CHOOSE MATCHING LAMPSHADES



LALU® TETRA 14	black/antique bronze	IP20	Diameter: 14 cm, H: 4.9 cm	1007523	
	white/gold			1007522	
	antique bronze			1007521	
LALU® TETRA 24	black/antique bronze	IP20	Diameter: 24 cm, H: 6.7 cm	1007526	
	white/gold			1007525	
	antique bronze			1007524	
LALU® TETRA 36	black/antique bronze	IP20	Diameter: 36 cm, H: 8.9 cm	1007529	
	white/gold			1007528	
	antique bronze			1007527	
LALU® CONE 15	black/antique bronze	-	Diameter: 15.2 cm, H 17 cm	1007532	
	white/gold			1007531	
	antique bronze			1007530	
LALU® ELYPSE 15	black/antique bronze	-	Diameter: 15 cm, H 1.4 cm	1007535	
	white/gold			1007534	
	antique bronze			1007533	
LALU® ELYPSE 22	black/antique bronze	-	Diameter: 22 cm, H 2.8 cm	1007538	
	white/gold			1007537	
	antique bronze			1007536	
LALU® ELYPSE 33	black/antique bronze	-	Diameter: 3.5 cm L: 8 cm	1007541	
	white/gold			1007540	
	antique bronze			1007539	
LALU® PLATE 15	black/antique bronze	-	Diameter: 15 cm, H 1.5 cm	1007544	
	white/gold			1007543	
	antique bronze			1007542	
LALU® PLATE 22	black/antique bronze	-	Diameter: 22 cm, H 1.5 cm	1007547	
	white/gold			1007546	
	antique bronze			1007545	



MIX & MATCH

LALU®

LALU® TETRA 14

black | 1007523
white | 1007522
antique bronze | 1007521



LALU® CONE 15

black | 1007532
white | 1007531
antique bronze | 1007530

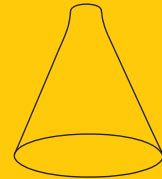

LALU® TETRA 24

black | 1007526
white | 1007525
antique bronze | 1007524



LALU® TETRA 36

black | 1007529
white | 1007528
antique bronze | 1007527



LALU®

PD, LED BASE, PHASE

black | 1007518
white | 1007519
antique bronze | 1007520



LALU®

PD, LED BASE, PHASE, RECESSED

black | 1007548
white | 1007549
antique bronze | 1007550



LALU® ELYPSE 15

black	1007535
white	1007534
antique bronze	1007533



LALU® PLATE 15

black	1007544
white	1007543
antique bronze	1007542



LALU® ELYPSE 22

black	1007538
white	1007537
antique bronze	1007536



LALU® PLATE 22

black	1007547
white	1007546
antique bronze	1007545



LALU® ELYPSE 33

black	1007541
white	1007540
antique bronze	1007539



LALU®

PD, LED BASE, 48V, DALI

black	1007749
white	1007748
antique bronze	1007747



Mix and match products in the LALU® family to suit your taste. Perfectly coordinated, you can mix and match the shapes, sizes and colours or create a setup with multiple lights. Get creative – You can recognise SLV Mix & Match products by the following symbol:



MIX
match

LALU®
1007658





LALU®
Pendant light (PD)

SOCKET
INSIDE



LALU®
PD, E27



IP20

150

220-240V ~50/60Hz
Material: aluminium

● - IP20 - 10W 1xE27 - 1007658 ●



LALU®
Shade, E27 Base

black/antique bronze

antique bronze

Diameter: 33 cm H: 3.5 cm

1007659 ●

1007660 ●



A60
180°, EEK=F, 8kWh/1000h



7,5W

2700K

720lm

-

1005305

LALU® SIZES

PENDANT LIGHTS

MIX
match



LALU® TETRA 14
PD, SHADE

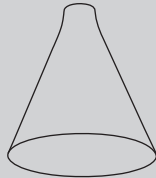

LALU® CONE 15
PD, SHADE



LALU® ELYPSE 15
PD, SHADE



LALU® PLATE 15
PD, SHADE



LALU® TETRA 24
PD, SHADE



LALU® ELYPSE 22
PD, SHADE



LALU® PLATE 22
PD, SHADE

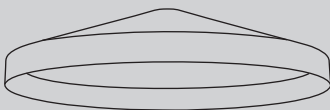

LALU® TETRA 36
PD, SHADE



LALU® ELYPSE 33
PD, SHADE

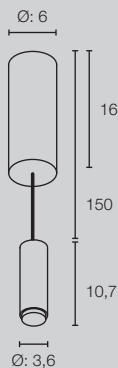

LALU®
PD, LED BASE, PHASE

Installation dimensions:
Diameter: 6.8 cm D: 5 cm

LALU®
PD, LED BASE, PHASE, RECESSED

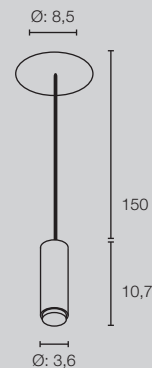

Ø: 3,6

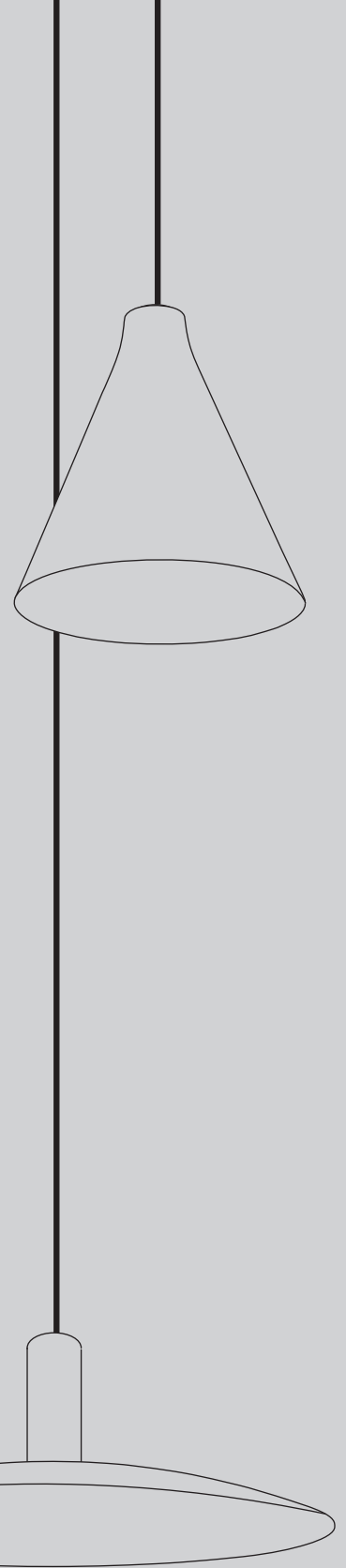
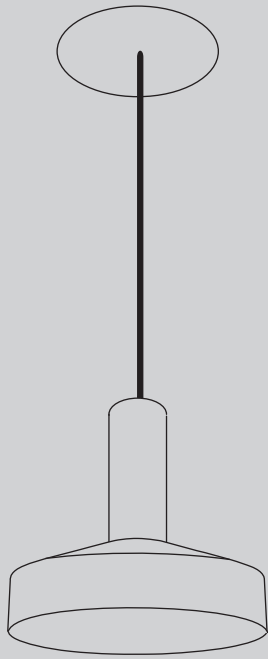

LALU®
PD, SHADE

SOCKET
INSIDE

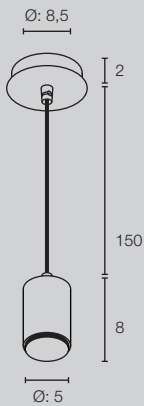

LALU®
PD, E27

ONE® 60
1005177





ONE®
Pendant lights (PD)



ONE® TRIPLE DALI



ONE® 60 DALI



ONE® DOUBLE
PD DALI UP/DOWN



ONE® CUBE
DALI UP/DOWN

ONE® 60 PD, Dali



220-240V ~50/60Hz
Material: aluminium/steel

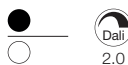

IP20 600mA 24W CCT 3000 / 4000K 1480 / 1550lm

1002909

1002910



ONE® 60 PD, Up/Down, Dali

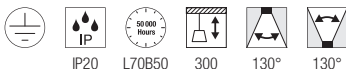

220-240V ~50/60Hz
Material: aluminium/steel

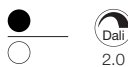

IP20 600mA 25W CCT 3000 / 4000K 400 / 410lm
800 / 820lm

1004761

1004762



ONE® 60 PD, Up/Down, Phase



220-240V ~50/60Hz
Material: aluminium/steel



IP20 600mA 24W CCT 2700 / 3000K 410 / 415lm

1004759

1004760

1005177



ONE® 80 PD, Dali



220-240V ~50/60Hz
Material: aluminium/steel



IP20 800mA 32W CCT 3000 / 4000K 1930 / 2140lm

1002911

1002912



ONE® 80 PD, Up/Down, Dali

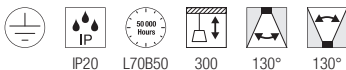

220-240V ~50/60Hz
Material: aluminium/steel



IP20 800mA 34W CCT 3000 / 4000K 615 / 635lm

1004763

1004764





ONE® DOUBLE PD, Up/Down, Dali

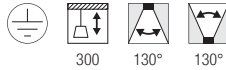

220-240V ~50/60Hz
Material: aluminium/steel

		-	1400mA	55W	CCT 3000 / 4000K	1050 / 1060lm	1004767
							1004768



ONE® DOUBLE PD, Up/Down, Phase

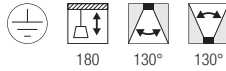

220-240V ~50/60Hz
Material: aluminium/steel

		-	900mA	35W	CCT 2700 / 3000K	615 / 635lm	1004765
							1004766
							1005178



ONE® TRIPLE PD, Dali

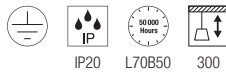

220-240V ~50/60Hz
Material: aluminium/steel

		IP20	1700mA	64W	CCT 3000 / 4000K	4040 / 4200lm	1002913
	2.0						1002914



ONE® CUBE PD, Dali



220-240V ~50/60Hz
Material: aluminium/steel

		IP20	1400mA	54W	3000K	4000lm	1007661 ●
							1007662 ●
	2.0	IP20	1400mA	54W	4000K	4300lm	1007663 ●
							1007664 ●



ONE® CUBE PD, Up/Down, Dali



220-240V ~50/60Hz
Material: aluminium/steel

		IP20	2100mA	80W	3000K	UP 2000lm DOWN 4000lm	1007665 ●
							1007666 ●
	2.0	IP20	2100mA	80W	4000K	UP 2200lm DOWN 4300lm	1007671 ●
							1007672 ●



ONE® LINEAR 140
1006190





ONE® LINEAR 100

ONE® LINEAR 140

ONE® LINEAR 100
PD, Up/Down, Phase

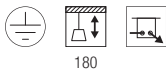

180

220-240V ~50/60Hz
Material: aluminium/steel

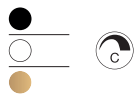

- 600mA 24W CCT 2700 / 3000K

UP 550 / 580lm
DOWN 670 / 700lm

1006185

1006186

1006187



ONE® LINEAR 140
PD, Up/Down, Phase



180

220-240V ~50/60Hz
Material: aluminium/steel

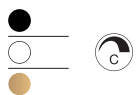

- 900mA 35W CCT 2700 / 3000K

UP 830 / 860lm
DOWN 980 / 1015lm

1006188

1006189

1006190



Detailed measurements and assembly information can be found on pages 200–201

ONE® 60
1002919



ONE® DOUBLE
1004766

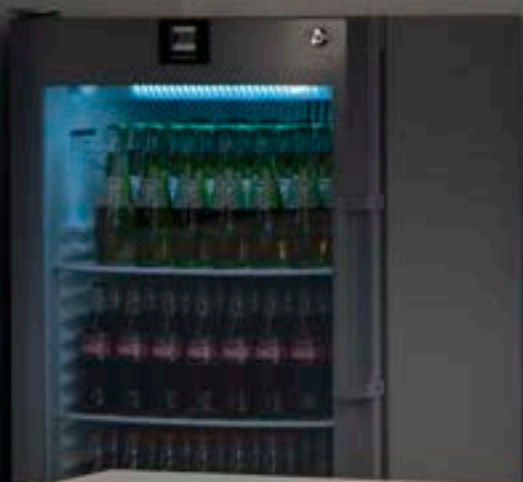
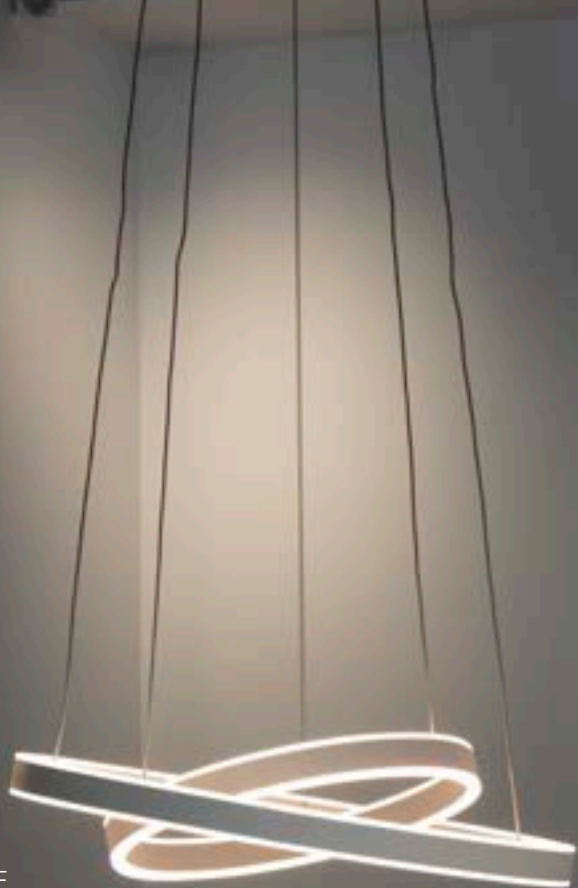



ONE®
Wall and ceiling lights (CW)

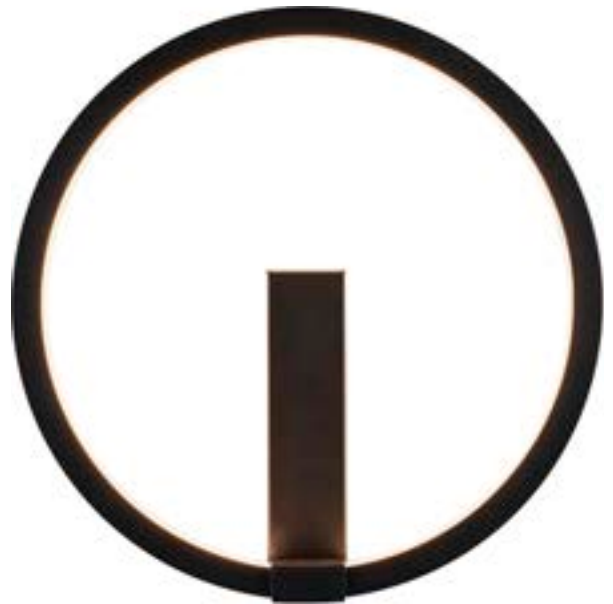

ONE® 40
CW, Dali



220-240V ~50/60Hz
Material: aluminium/steel



IP20

350mA

14W

CCT 3000 / 4000K

700 / 730lm

1002915

1002917



ONE® 60
CW, Dali



220-240V ~50/60Hz
Material: aluminium/steel



IP20

600mA

24W

CCT 3000 / 4000K

1350 / 1430lm

1002918

1002919



Detailed measurements and assembly information can be found on pages 200–201



ONE® 40 TRACK
1004769

ONE® 40 TRACK
Track 3Ph, Dali

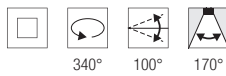

220-240V ~50/60Hz
Material: aluminium

●	-	350mA	15,2W	3000K	650lm	1004769
○	-	350mA	15,2W	4000K	670lm	1004770
●	-	350mA	15,2W	4000K	670lm	1004771
○	-	350mA	15,2W	4000K	670lm	1004772



Detailed measurements and assembly information can be found on pages 200–201



ONE® 40 TRACK
1004771

ONE® 40 TRACK
Track 3-phase system



Can be
pivoted 100° and
rotated 340°



ONE®
Floor lamps (FL)



ONE® STRAIGHT
FL, Up/Down

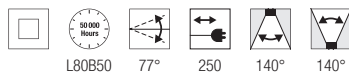

220-240V ~50/60Hz
Material: steel/polycarbonate (PC)



-

24V

22W

CCT 2700 / 3000K

UP 600 / 600lm
DOWN 600 / 600lm

UGR<22

1006355 ●

1006354 ●

1006353 ●











 Luminous flux of
 ring can be individually
 adjusted

NEW

ONE® BOW
FL, Up/Down

						
L80B50	50 000 Hours	60°	120°	250	140°	140°

220-240V ~50/60Hz
Material: steel/polycarbonate (PC)

  		-	24V	22W	CCT 2700 / 3000K	UP 600 / 600lm DOWN 600 / 600lm	UGR<22	1006352 ● 1006351 ● 1006350 ●
---	---	---	-----	-----	------------------	------------------------------------	--------	--

Detailed measurements and assembly information can be found on pages 200–201



ONE® STRAIGHT
1006353



ONE® BOW
1006351

ONE® SIZES

PENDANT LIGHTS

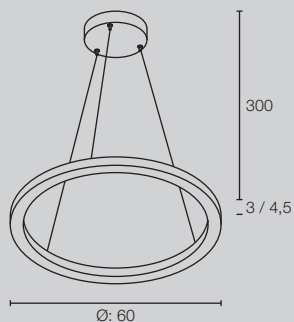

ONE® 60 / **ONE® 60**
PD, DALI / PD, UP/DOWN, DALI

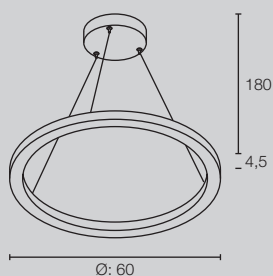

ONE® 60
PD, UP/DOWN, PHASE

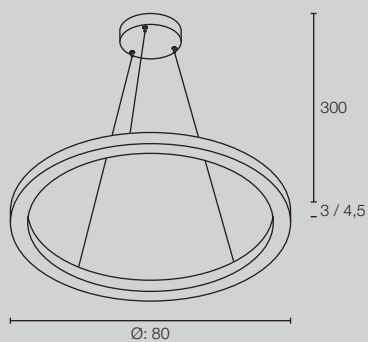

ONE® 80 / **ONE® 80**
PD, DALI / PD, UP/DOWN, DALI

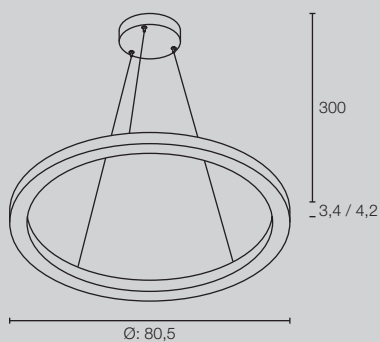

ONE® CUBE / **ONE® CUBE**
PD, DALI / PD, UP/DOWN, DALI

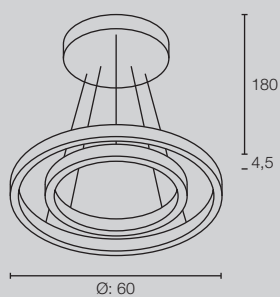

ONE® DOUBLE 60
PD, UP/DOWN, DALI

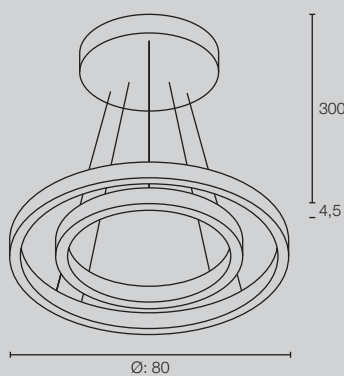

ONE® DOUBLE 80
PD, UP/DOWN, DALI

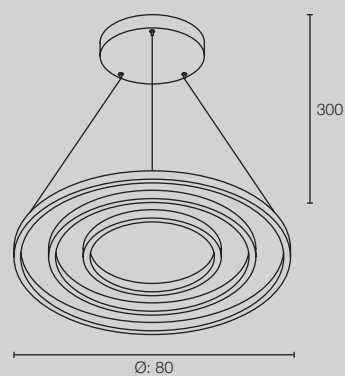

ONE® TRIPLE
PD, DALI

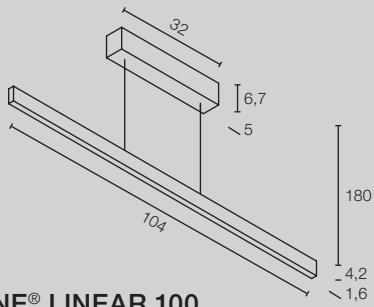

ONE® LINEAR 100
PD, UP/DOWN, DALI

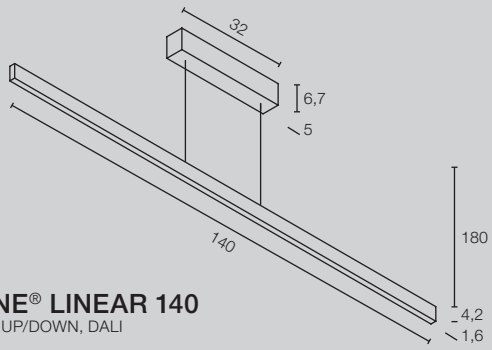

ONE® LINEAR 140
PD, UP/DOWN, DALI

WALL LIGHTS

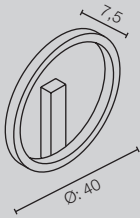

ONE® 40
CW, DALI

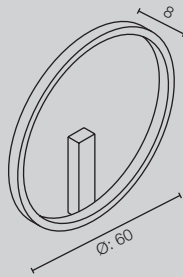

ONE® 60
CW, DALI

TRACK SYSTEM

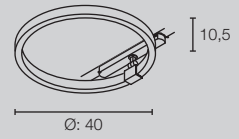

ONE® 40 TRACK
TRACK 3PH, DALI

FLOOR LAMPS

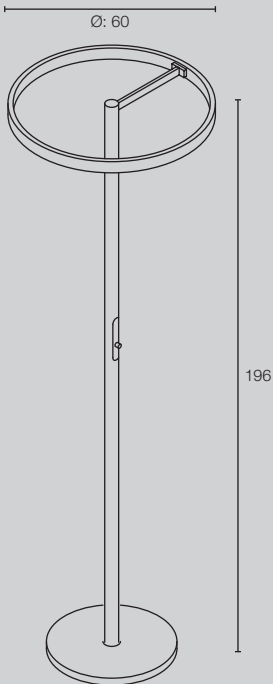

ONE® STRAIGHT
FL, UP/DOWN, SWITCH

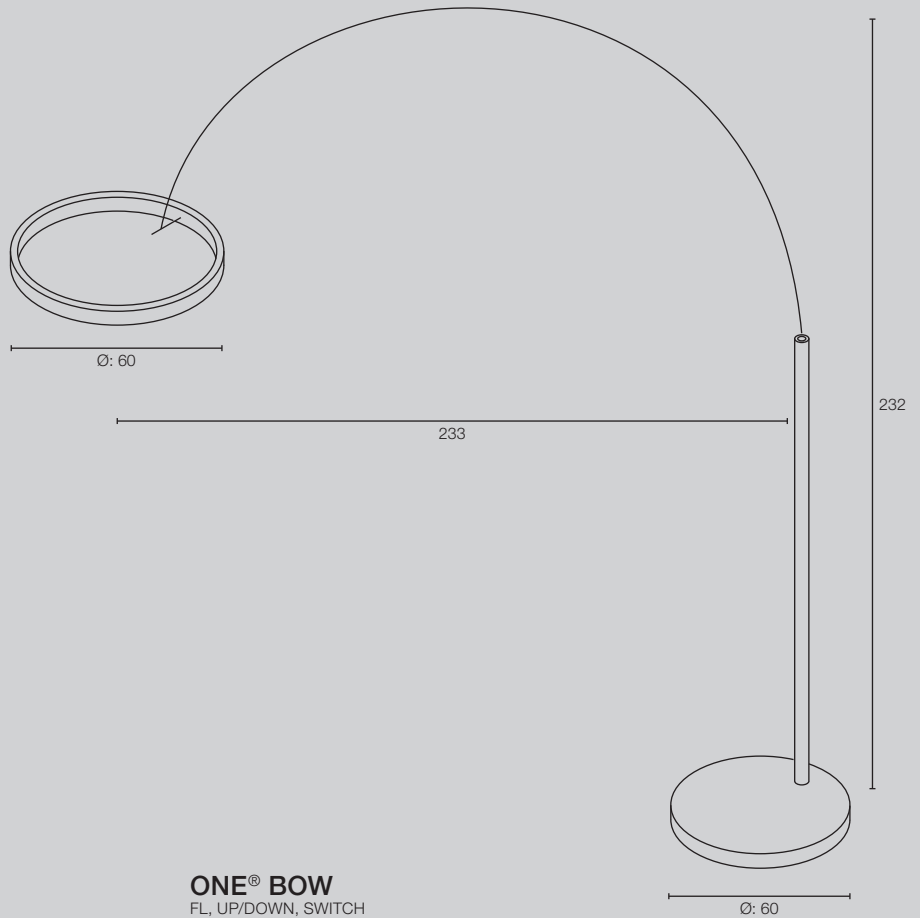

ONE® BOW
FL, UP/DOWN, SWITCH



NUMINOS®
can be found
on family pages
82–93

LED



NEW TRIA®
can be found
on family pages
122–147

LED



MEDO®
can be found
on family pages
168–171

LED



NEW

LED

UNIVERSAL
DOWNLIGHT | 205



NEW

LED

UNIVERSAL
DOWNLIGHT | 207



NEW

LED

UNIVERSAL
DOWNLIGHT | 208



NEW

LED

UNIVERSAL
DOWNLIGHT | 209



NEW

LED

KADUX | 213



NEW

LED

KADUX | 213



NEW

LED

KADUX | 213



SCKET

KADUX | 214



SCKET

KADUX | 214



SCKET

KADUX | 214



SCKET

KADUX | 215



SCKET

KADUX | 215



LED

MILANDOS 4 | 217



LED

MILANDOS 6 | 217



LED

MILANDOS 8 | 217



LED

HORN MINI | 218



SCKET

HORN | 219



SCKET

HORN | 219



SCKET

HORN | 219



SCKET

HORN | 220



SCKET

HORN | 220



SCKET

HORN | 220



SCKET

HORN-T | 221



LED

HORN MAGNA | 221



LED

SENER 12 | 223



LED

SENER 18 | 223



LED

SENER 24 | 223



LED

SENER 12 | 225



LED

SENER 18 | 225



LED

SENER 24 | 225



LED

VERLUX | 227



LED

VERLUX | 227



LED

DL 126 | 227



SCKET

PIKA | 228



SCKET

PIKA | 228



LED

OCULUS | 229



LED
OCCULDAS 14 | 230



LED
OCCULDAS 23 | 230



LED
CONTONE® | 231



LED
CONTONE® | 231



LED
H-LIGHT | 232



LED
KARPO 30 | 232



SCKET
PLASTRA | 233



SCKET
PLASTRA | 233



LED
DEKLED | 234



SCKET
VARU | 234



SCKET
DOLIX OUT | 235



SCKET
DOLIX OUT | 235



LED
KAMUELA ECO | 236



LED
KAMUELA ECO | 237



LED
KINI | 237



LED
AKALO D83 | 237



LED
FRAME BASIC SET | 238



LED
FRAME BASIC | 238



LED
FRAME BASIC | 238



LED
FRAME CURVE | 239



LED
FRAME CURVE | 239



LED
QUAD FRAME 9 | 240



LED
NOTAPO S | 241



LED
NOTAPO L | 241



LED
DOWNUNDER PUR 80 | 242



LED
DOWNUNDER PUR 150 | 242



LED
MOBALA | 243



LED
WORO | 243



LED
LED PANEL | 243



LED
PATTA-I | 244



LED
PATTA-I | 244



LED
PATTA-I | 245



LED
PATTA-I | 245



LED
PATTA-F | 246



LED
PATTA-F | 247

1007095 + 1007180 205

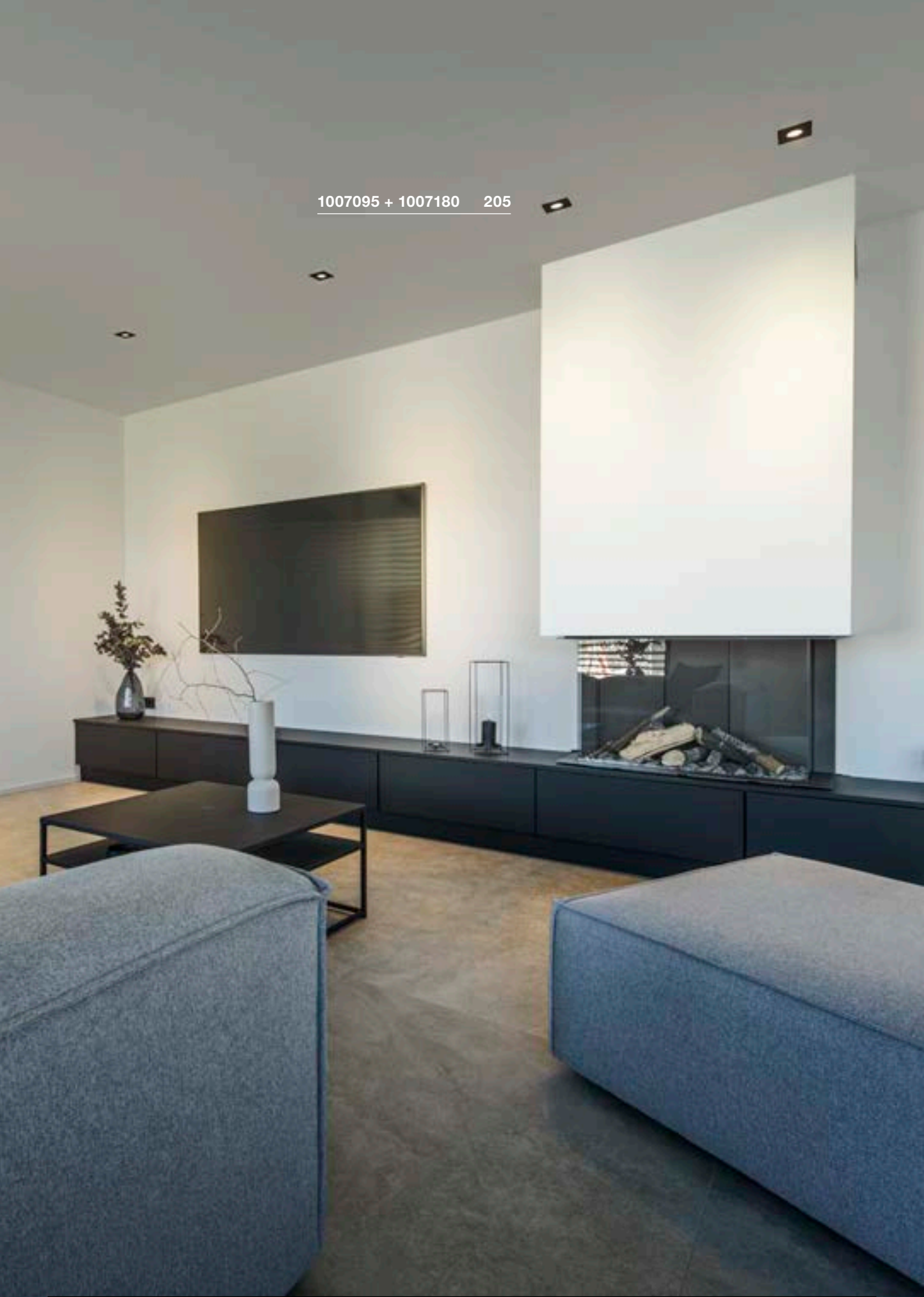



UNIVERSAL DOWNLIGHT Cover, round



Diameter: 8.8 cm
H: 0.35 cm
Material: polycarbonate (PC)

Options	Prod. no.
● black	1007096 ●
○ white	1007097 ●
● gold	1007099 ●
● matt gold	1007192 ●
● aluminium	1007098 ●

UNIVERSAL DOWNLIGHT DL, PHASE

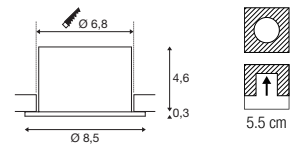

UNIVERSAL DOWNLIGHT Cover, square



L: 8.8 cm
W: 8.8 cm
H: 0.35 cm
Material: polycarbonate (PC)

Options	Prod. no.
● black	1007180 ●
○ white	1007181 ●
● gold	1007183 ●
● matt gold	1007193 ●
● aluminium	1007182 ●



220-240V ~50/60Hz | 60/90mA
Total wattage: 5W/8W
Material: steel

- Material thickness of mounting surface: max. 25 mm



5W	410lm	2700K
	430lm	3000K
	470lm	4000K
	440lm	6500K
8W	560lm	2700K
	610lm	3000K
	680lm	4000K
	640lm	6500K

Options	Prod. no.
● black	1007095 ●

1007090 + 1007184 205



WATCH OUT
MONSTER INSIDE



1002



UNIVERSAL DOWNLIGHT Cover, round



Diameter: 8.8 cm
H: 0.35 cm
Material: polycarbonate (PC)

Options	Prod. no.
● black	1007091 ●
○ white	1007092 ●
● gold	1007094 ●
● matt gold	1007191 ●
● aluminium	1007093 ●

UNIVERSAL DOWNLIGHT DL, Move, PHASE

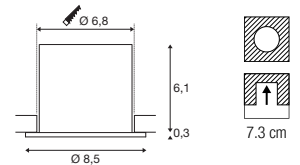

UNIVERSAL DOWNLIGHT Cover, square



L: 8.8 cm
W: 8.8 cm
H: 0.35 cm
Material: polycarbonate (PC)

Options	Prod. no.
● black	1007184 ●
○ white	1007185 ●
● gold	1007187 ●
● matt gold	1007194 ●
● aluminium	1007186 ●

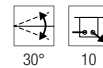

220-240V ~50/60Hz | 60/90mA
Total wattage: 5W/8W
Material: steel

- Material thickness of mounting surface: max. 25 mm



5W	410lm	2700K
	610lm	3000K
	680lm	4000K
	640lm	6500K
8W	560lm	2700K
	610lm	3000K
	680lm	4000K
	640lm	6500K

Options	Prod. no.
● black	1007090 ●

UNIVERSAL DOWNLIGHT
DL with Cover, Multipack

1007271 208

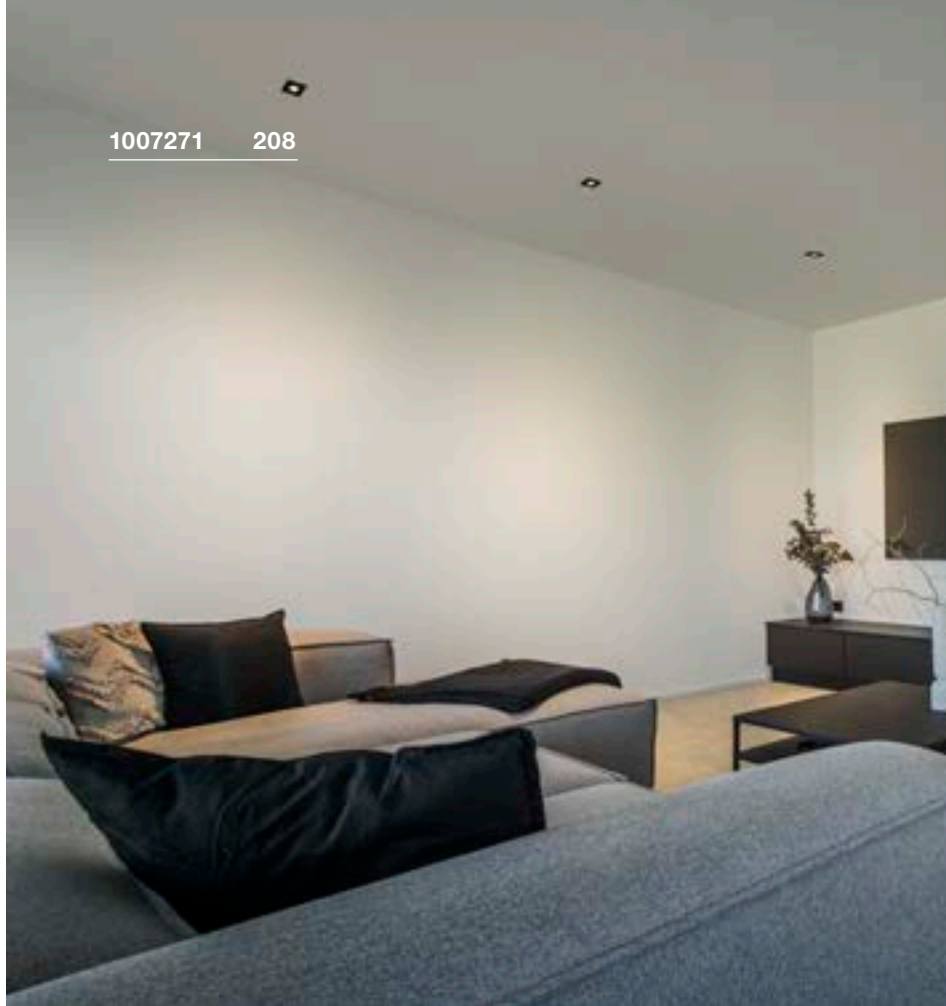
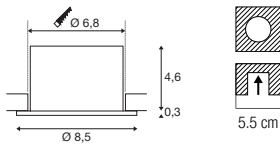

IP 20
IP 65

IK02

38°

UGR 28

L70B50

10

220-240V ~50/60Hz | 60/90mA
Total wattage: 5W/8W
Material: steel

- Material thickness of mounting surface:
max. 25 mm



5W	560lm	2700K
	610lm	3000K
	680lm	4000K
	640lm	6500K
8W	560lm	2700K
	610lm	3000K
	680lm	4000K
	640lm	6500K

Options	Prod. no.
● black	1007271
○ white	1007272

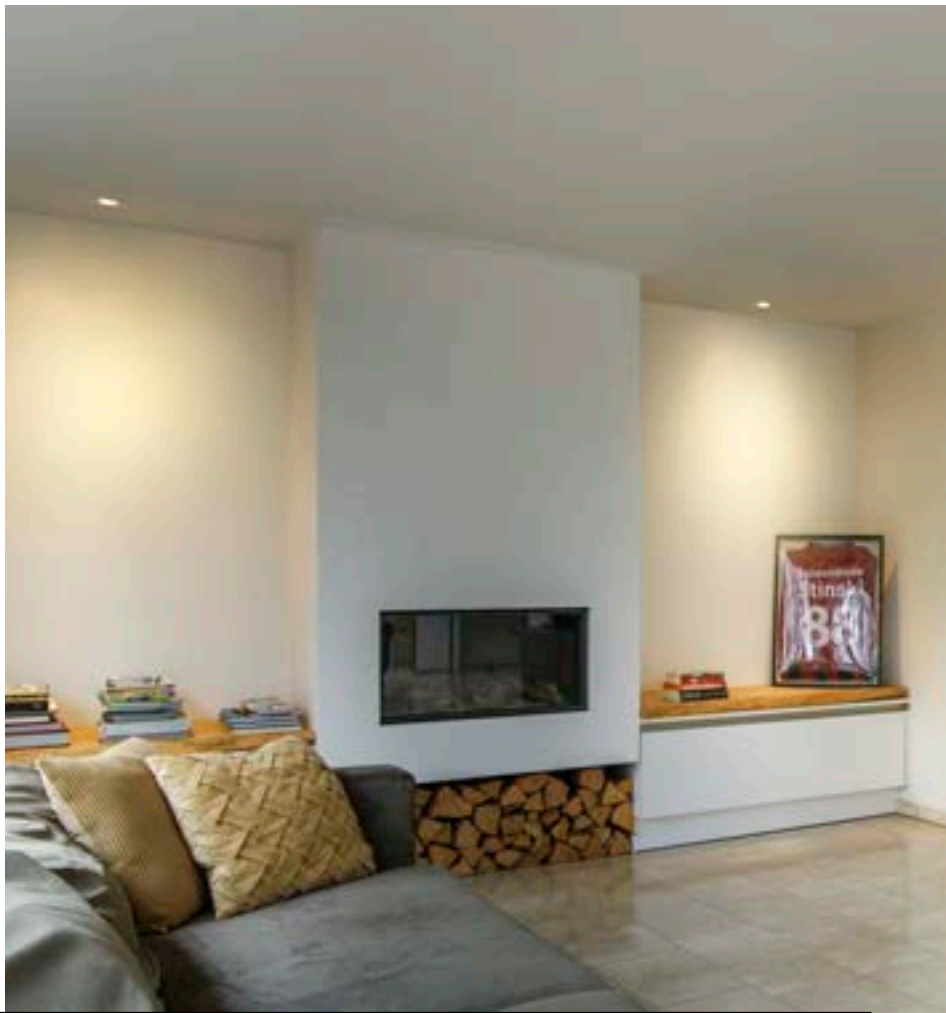



UNIVERSAL DOWNLIGHT DL with Cover, Multipack



NEW

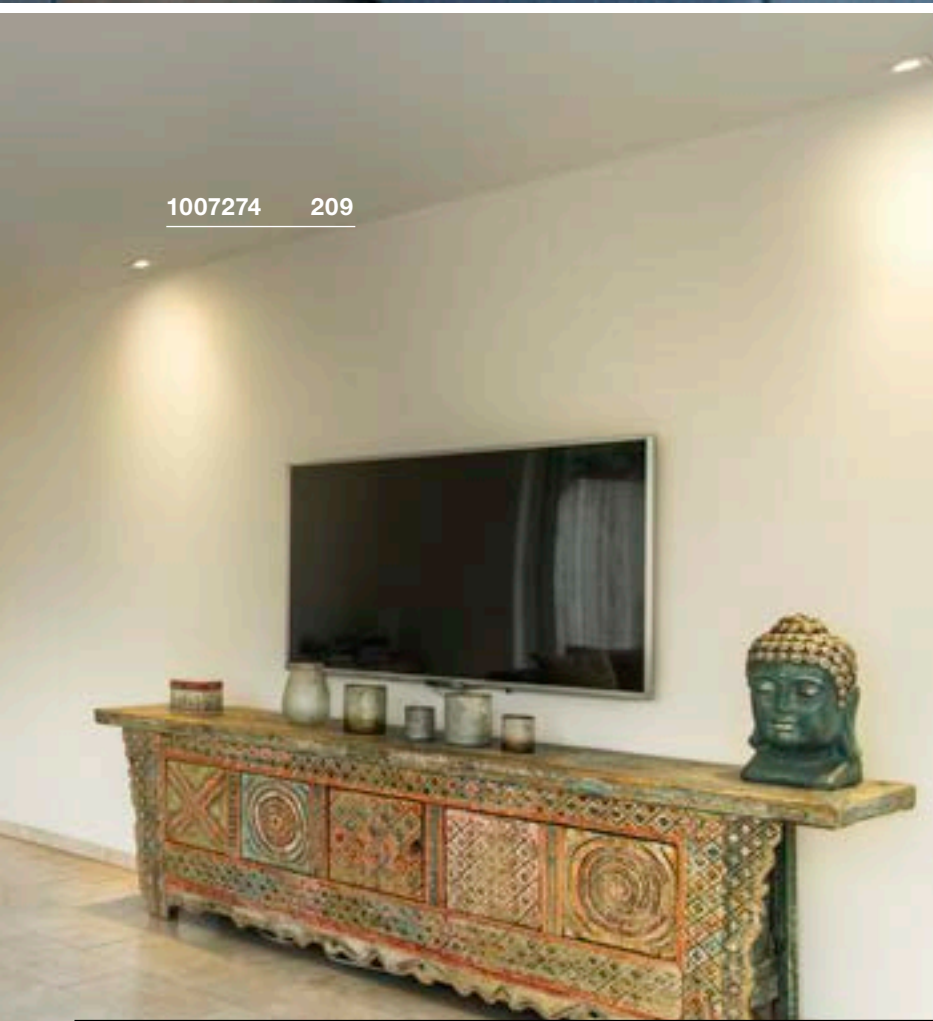
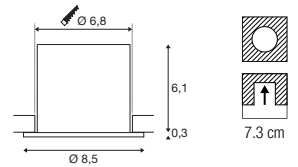

1007274 209

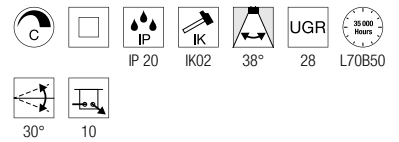

220-240V ~50/60Hz | 60/90mA
Total wattage: 5W/8W
Material: steel

- Material thickness of mounting surface: max. 25 mm



5W	410lm	2700K
	610lm	3000K
	680lm	4000K
	640lm	6500K
8W	560lm	2700K
	610lm	3000K
	680lm	4000K
	640lm	6500K

Options	Prod. no.
● black	1007273
○ white	1007274

DESIGN YOUR DOWNLIGHT

Unobtrusive and universally applicable: the UNIVERSAL DOWNLIGHT as a rigid and pivoting version are recessed lights that produce a targeted light with their narrow beam angle of 36 degrees. A wide range of colour temperature options (2700/3000/4000/6000K) can be selected via the CCT switch before installation. Natural colour reproduction is achieved with a CRI of over 90. The Quick Connector Box ensures the downlight is quick and easy to install. Complement your universal downlight with the separately available round or square cover, available in black, white, chrome, gold glossy and gold matt.

CHOOSE YOUR FAVOURITE ...

- 1 Version (rigid, pivoting)
- 2 Bezel (black, white, chrome, gold glossy, gold matt)
- 3 Colour temperature (2700, 3000, 4000, 6500K)
- 4 Total wattage (5W, 8W)



DONE!

UNIVERSAL DOWNLIGHT

UNIVERSAL DOWNLIGHT



Available as a square or round rigid version

UNIVERSAL DOWNLIGHT MOVE



Available as a square or round pivoting version

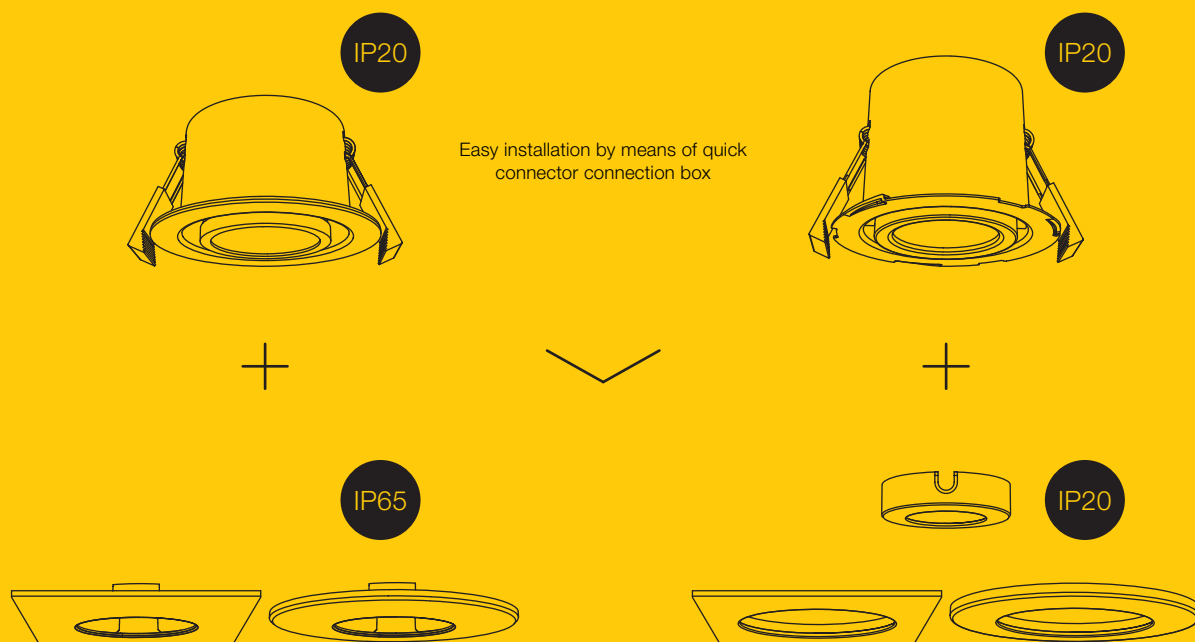

Replaceable bezel in square or round and in the colours black, white, chrome, gold glossy or gold matt

2700K 3000K 4000K 6500K Adjustable colour temperature 2700K 3000K 4000K 6500K

Adjustable total wattage 5W / 8W

High light quality and colour reproduction
thanks to LED with CRI90

1007560 213



1007567 213



1007551 213

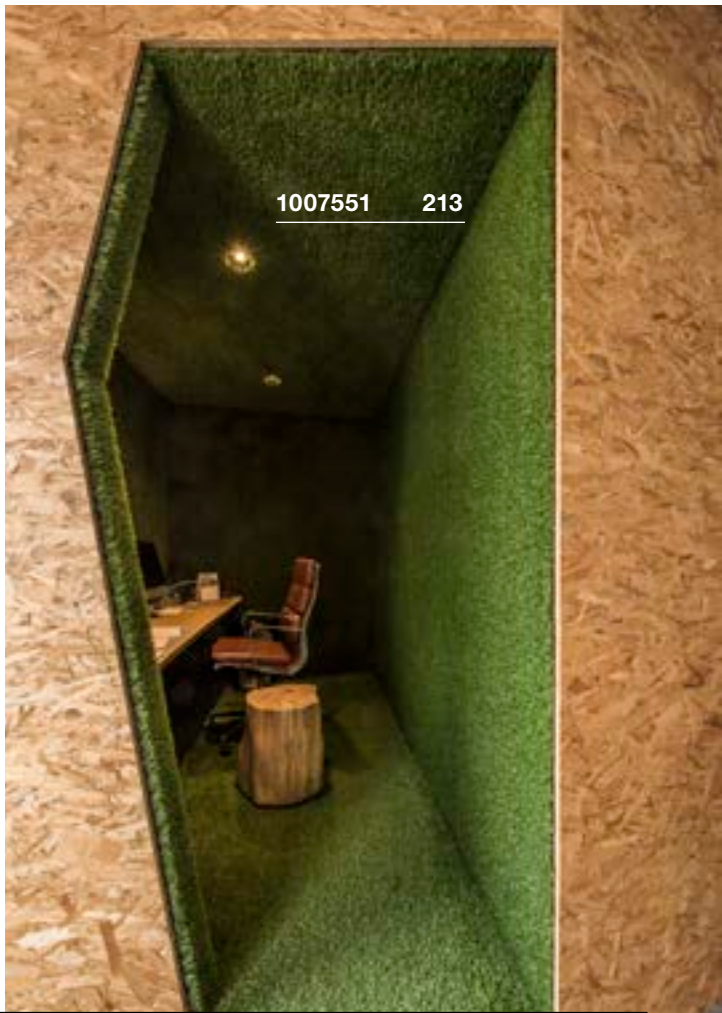



KADUX
DL, single, PHASE

KADUX
DL, double, PHASE

KADUX
DL, triple, PHASE

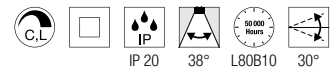
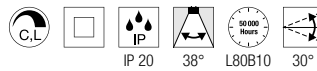
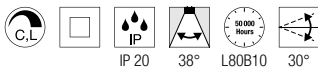
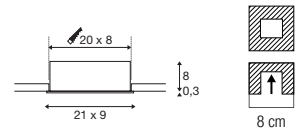
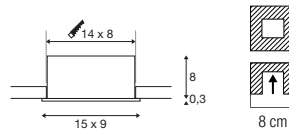
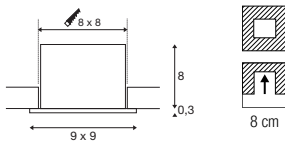

220-240V ~50/60Hz | 350mA
Total wattage: 7.5W
Material: aluminium/steel

220-240V ~50/60Hz | 350mA
Total wattage: 14W
Material: aluminium/steel

220-240V ~50/60Hz | 350mA
Total wattage: 20W
Material: aluminium/steel

- Spring clips
- Material thickness of mounting surface: max. 30 mm

- Spring clips
- Material thickness of mounting surface: max. 30 mm

- Spring clips
- Material thickness of mounting surface: max. 30 mm



Down 770lm | 3000K

Down 1510lm | 3000K

Down 2310lm | 3000K

Options	Prod. no.
● black	1007551 ●
○ white	1007552 ●

Options	Prod. no.
● black	1007559 ●
○ white	1007560 ●

Options	Prod. no.
● black	1007567 ●
○ white	1007568 ●

KADUX
EL, single, QPAR51

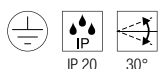
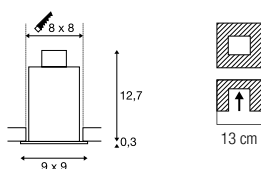

220-240V ~50/60Hz
Material: aluminium/steel

- Spring clips
- Material thickness of mounting surface: max. 30 mm



Base: 1xGU10

Options	Prod. no.
● black	115510
○ white	115511

LED GU10 51mm | 6W | 36°
 2200-2700K | 360lm | EEK=G
 6kWh/1000h

Prod. no.: 1005273

KADUX
EL, double, QPAR51

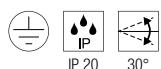
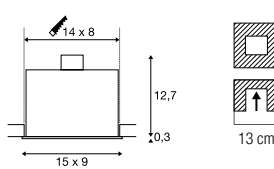

220-240V ~50/60Hz
Material: aluminium/steel

- Spring clips
- Material thickness of mounting surface: max. 30 mm



Base: 2xGU10

Options	Prod. no.
● black	115520
○ white	115521

LED GU10 51mm | 6W | 36°
 2200-2700K | 360lm | EEK=G
 6kWh/1000h

Prod. no.: 1005273

KADUX
EL, triple, QPAR51

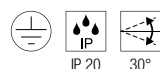
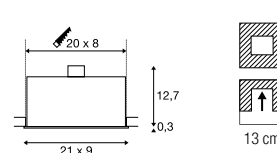

220-240V ~50/60Hz
Material: aluminium/steel

- Spring clips
- Material thickness of mounting surface: max. 30 mm



Base: 3xGU10

Options	Prod. no.
● black	115530
○ white	115531

LED GU10 51mm | 6W | 38°
 3000K | 470lm | EEK=F
 6kWh/1000h

Prod. no.: 1005079



115550 215

KADUX
EL, single, QPAR111

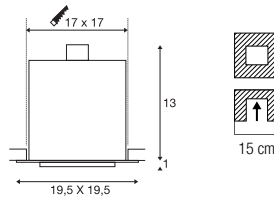

KADUX
EL, double, QPAR111

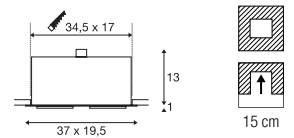

115531 214

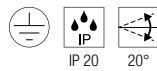

220-240V ~50/60Hz
Material: aluminium/steel

- Spring clips
- Material thickness of mounting surface: max. 25 mm



Base: 1xGU10

Options	Prod. no.
● black	115540
○ white	115541



QPAR111 | 8W | 38°
2700K | 680lm | EEK=F
8kWh/1000h

Prod. no.: 1005274

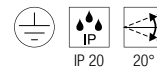

220-240V ~50/60Hz
Material: aluminium/steel

- Spring clips
- Material thickness of mounting surface: max. 25 mm



Base: 2xGU10

Options	Prod. no.
● black	115550
○ white	115551



QPAR111 | 8W | 38°
2700K | 680lm | EEK=F
8kWh/1000h

Prod. no.: 1005274







MILANDOS 4 DL

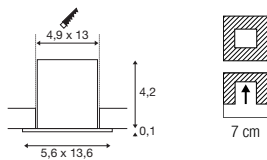

700mA
Power consumption: 8W
Material: aluminium/polycarbonate (PC)

- Spring clips
- Material thickness of mounting surface: max. 40mm



Down	510lm 2700K 520lm 3000K 650lm 3000K
------	---

Options	Prod. no.
● black 510lm 2700K	1005407
● black 520lm 3000K	1005408
○ white 650lm 3000K	1005410



Product	Prod. no.
LED driver 20W 250-700mA 1-10V/DALI dimmable inc. strain relief	
○ white	1002423
LED driver 10W 700mA dimmable inc. strain relief	
○ white	1007213 ●

MILANDOS 6 DL

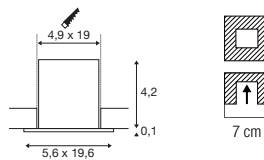

700mA
Power consumption: 12W
Material: aluminium/polycarbonate (PC)

- Spring clips
- Material thickness of mounting surface: max. 40mm



Down	770lm 2700K 780lm 3000K 980lm 3000K
------	---

Options	Prod. no.
● black 770lm 2700K	1005415
● black 780lm 3000K	1005416
○ white 980lm 3000K	1005418



Product	Prod. no.
LED driver 15W 700mA strain relief included	
○ white	1006202
LED driver 20W 700mA dimmable strain relief included	
○ white	1002423

MILANDOS 8 DL

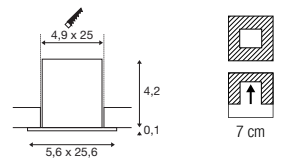

700mA
Power consumption: 16W
Material: aluminium/polycarbonate (PC)

- Spring clips
- Material thickness of mounting surface: max. 40mm



Down	1030lm 2700K 1040lm 3000K
------	----------------------------------

Options	Prod. no.
● black 1030lm 2700K	1005423
● black 1040lm 3000K	1005424



Product	Prod. no.
LED driver 20W 250-700mA 1-10V/DALI dimmable inc. strain relief	
○ white	1002423
LED driver 20W 700mA dimmable inc. strain relief	
○ white	1006202

HORN MINI EL

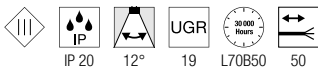
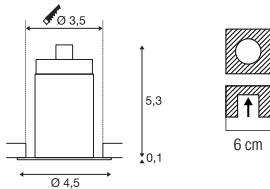

350mA
Power consumption: 1W
Material: aluminium/polycarbonate (PC)

- Spring clips
- AMP plug included
- Different light colour with golden reflector
- Driver not included



Down 70lm | 2900K
3000K

Options	Prod. no.
● black 3000K	1000915
● black/gold 2900K	1000917
○ white 3000K	1000914



Product	Prod. no.
1m cable extension	
○ white	111861
LED driver 3W 350mA inc. AMP socket	
○ white	1007270 ●
Connector strip 3 outlets	
● black	111850

113141 219



1000914 218





HORN
DL, single, QPAR51

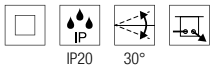
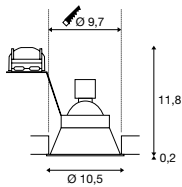

220-240V ~50/60Hz
Material: aluminium

- Spring clips
- Material thickness of mounting surface: max. 30 mm



Base: 1xGU10

Options	Prod. no.
● black	113140
○ white	113141



LED GU10 51mm | 6W | 38°
2700K | 450lm | EEK=F
6kWh/1000h



Prod. no.: 1005077

HORN
DL, double, QPAR51

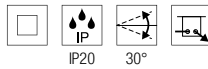
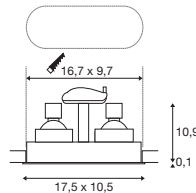

220-240V ~50/60Hz
Material: aluminium

- Spring clips
- Material thickness of mounting surface: max. 30 mm



Base: 2xGU10

Options	Prod. no.
● black	1006121
○ white	1006122



LED GU10 51mm | 6W | 38°
2700K | 450lm | EEK=F
6kWh/1000h



Prod. no.: 1005077

HORN
DL, single, asymmetric, QPAR51

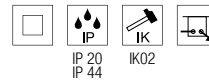
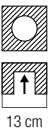
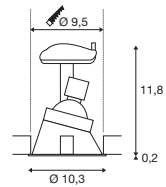

220-240V ~50/60Hz
Material: aluminium

- Spring clips
- Material thickness of mounting surface: max. 30 mm



Base: 1xGU10

Options	Prod. no.
● black	113150
○ white	113151



LED GU10 51mm | 6W | 36°
2200-2700K | 360lm | EEK=G



Prod. no.: 1005273

HORN
DL, single, QPAR51

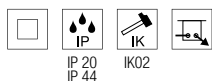
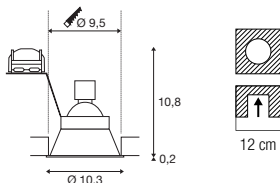

220-240V ~50/60Hz
Material: aluminium

- Spring clips
- Material thickness of mounting surface: max. 25 mm



Base: 1xGU10

Options	Prod. no.
● black	113160
○ white	113161

 LED GU10 51mm | 6W | 38°
 2700K | 450lm | EEK=F
 6kWh/1000h
 

Prod. no.: 1005077

HORN
EL, single, QPAR51

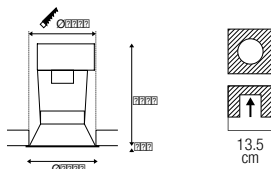



220-240V ~50/60Hz
Material: steel

- Spring clips
- Material thickness of mounting surface: max. 45mm



Base: 1xGU10 Max. Ø: 5.1 cm L: 5.4 cm

Options	Prod. no.
● black	112910
○ white	112911

 LED GU10 51mm | 6W | 38°
 2700K | 450lm | EEK=F
 6kWh/1000h
 

Prod. no.: 1005077

HORN
DL, GU10, blower door tested

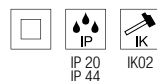
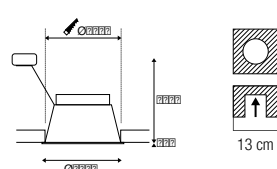



220-240V ~50/60Hz
Material: aluminium

- The downlight meets the RT2012 standards.
- Material thickness of mounting surface: max. 30 mm



Base: 1xGU10

Options	Prod. no.
● black	1005435
○ white	1005436



 LED GU10 51mm | 6W | 38°
 2700K | 450lm | EEK=F
 6kWh/1000h
 

Prod. no.: 1005077

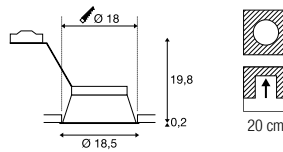

112911 220

**HORN-T
EL, QPAR111**



**HORN MAGNA
EL**

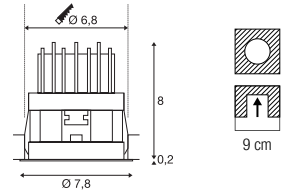

1002592 221

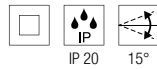

220-240V ~50/60Hz
Material: steel

- Spring clips
- Material thickness of mounting surface: max. 30 mm



Base: 1xGU10

Options	Prod. no.
● black	113170
○ white	113171



QPAR111 | 8W | 38°
2700K | 680lm | EEK=F
8kWh/1000h

Prod. no.: 1005274



500mA
Power consumption: 9W
Material: aluminium/polycarbonate (PC)

- Different light colour with golden reflector
- Spring clips
- Material thickness of mounting surface: max. 25 mm
- Open cable end



Down 445lm | 550lm | 570lm | 3000K

Options	Prod. no.
● black	445lm
● black/gold	550lm
○ white	570lm
○ white	3000K



Product	Prod. no.
LED driver 20W 350mA/500mA PHASE	
○ white	1007227
LED driver 25W 150-700mA DALI dimmable	
○ white	1007229
LED driver 21W 500mA strain relief included	
○ white	1007226

1003010 223





SENSER 12 EL, round

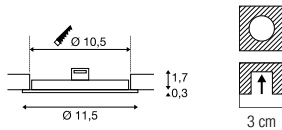

200mA
Power consumption: 6.4 W
Material: aluminium

- Spring clips
- Material thickness of mounting surface: max. 15mm



Down 420lm | 3000K
470lm | 4000K

Options	Prod. no.
○ white 420lm 3000K 6.4W	1003008
○ white 470lm 4000K 6W	1004694



Product	Prod. no.
LED driver 25W 150-700mA DALI dimmable ○ white	1007229 ●
LED driver 10W 200mA dimmable inc. strain relief ○ white	1007215 ●

SENSER 18 EL, round

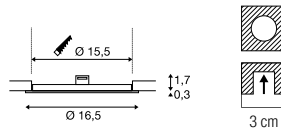

350mA
Power consumption: 10W
Material: aluminium

- Spring clips
- Material thickness of mounting surface: max. 15mm



Down 880lm | 3000K
990lm | 4000K

Options	Prod. no.
○ white 880lm 3000K 10W	1003009
○ white 990lm 4000K 12W	1004695



Product	Prod. no.
LED driver 20W 350mA dimmable ○ white	1007228 ●
LED driver 25W 150-700mA DALI dimmable ○ white	1007229 ●

SENSER 24 EL, round

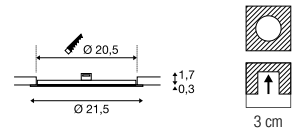

500mA
Power consumption: 13W
Material: aluminium

- Spring clips
- Material thickness of mounting surface: max. 15mm



Down 1200lm | 3000K
1300lm | 4000K

Options	Prod. no.
○ white 1200lm 3000K	1003010
○ white 1300lm 4000K	1004696



Product	Prod. no.
LED driver 20W 350mA/500mA PHASE ○ white	1007227 ●
LED driver 25W 150-700mA DALI dimmable ○ white	1007229 ●
LED driver 21W 500mA strain relief included ○ white	1007226 ●

1003011 225





SENSER 12 EL, square

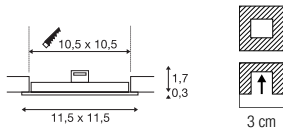

200mA
Power consumption: 6.4 W
Material: aluminium

- Spring clips
- Material thickness of mounting surface: max. 15mm



Down 440lm | 3000K | 4000K

Options	Prod. no.
○ white 3000K	1003011
○ white 4000K	1004697



Product	Prod. no.
LED driver 25W 150-700mA DALI dimmable ○ white	1007229 ●
LED driver 10W 200mA dimmable inc. strain relief ○ white	1007215 ●

SENSER 18 EL, square

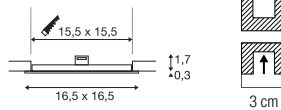

350mA
Power consumption: 10W
Material: aluminium

- Spring clips
- Material thickness of mounting surface: max. 15mm



Down 880lm | 4000K | 900lm | 3000K

Options	Prod. no.
○ white 900lm 3000K 10W	1003012
○ white 880lm 4000K 12W	1004698



Product	Prod. no.
LED driver 20W 350mA dimmable ○ white	1007228 ●
LED driver 25W 150-700mA DALI dimmable ○ white	1007229 ●

SENSER 24 EL, square

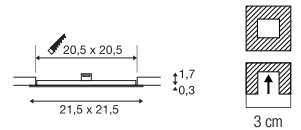

500mA
Power consumption: 13W
Material: aluminium

- Spring clips
- Material thickness of mounting surface: max. 15mm



Down 1100lm | 3000K | 1240lm | 4000K

Options	Prod. no.
○ white 1100lm 3000K	1003013
○ white 1240lm 4000K	1004699



Product	Prod. no.
LED driver 20W 350mA/500mA PHASE ○ white	1007227 ●
LED driver 25W 150-700mA DALI dimmable ○ white	1007229 ●
LED driver 21W 500mA strain relief included ○ white	1007226 ●

112682 227



112222 227



112225 227

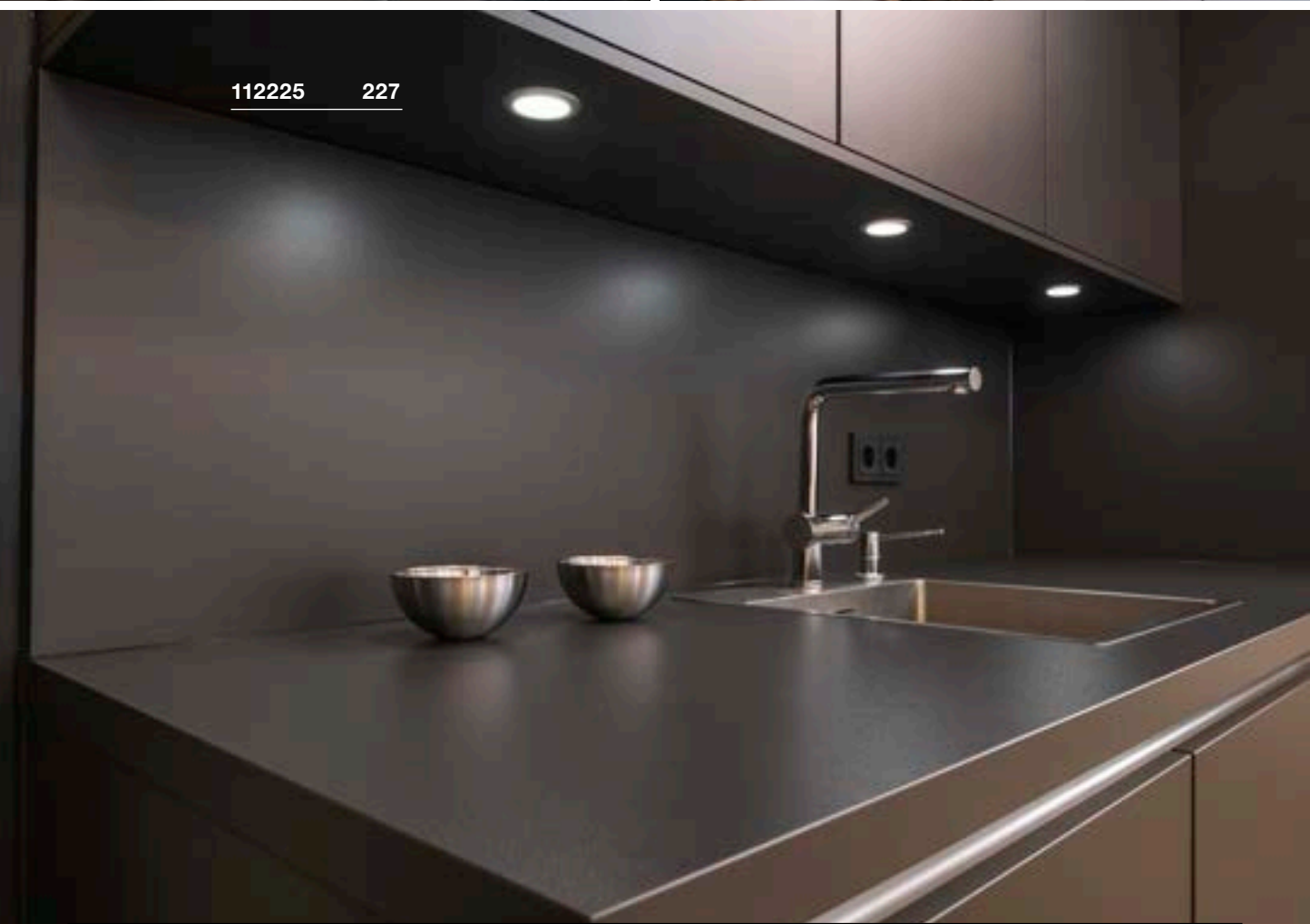



VERLUX
EL, square, PHASE

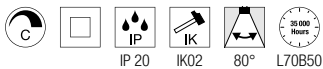
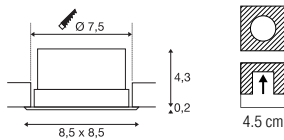

220-240V ~50/60Hz | 500mA
Total wattage: 11W
Material: aluminium/plastic

- Spring clips
- Material thickness of mounting surface: max. 20mm



Down 940lm | 3000K

Options	Prod. no.
<input type="radio"/> white	112682

VERLUX
EL, square, PHASE

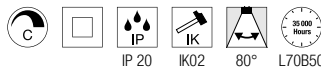
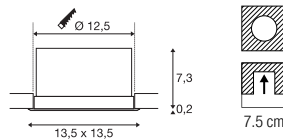

220-240V ~50/60Hz | 500mA
Total wattage: 22W
Material: aluminium/plastic

- Spring clips
- Material thickness of mounting surface: max. 25 mm



Down 1800lm | 3000K

Options	Prod. no.
<input type="radio"/> white	112692

DL 126
EL

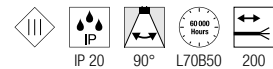
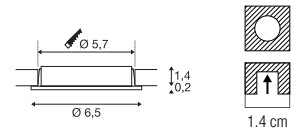

12V DC
Power consumption: 2.8W
Material: aluminium/plastic

- Spring clips



Down 170lm | 3000K

Options	Prod. no.
<input type="radio"/> white	112221
<input checked="" type="radio"/> chrome	112222
<input type="radio"/> grey	112225



Product	Prod. no.
LED power supply, 12/20W 24V inc. strain relief	
<input type="radio"/> white	1005381
LED power supply 15W 12V	
<input type="radio"/> white	1005444

PIKA
DL, round, QPAR51, rigid

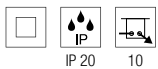
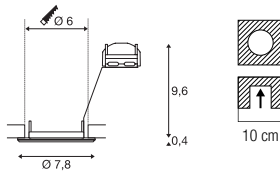

220-240V ~50/60Hz
Material: aluminium

- Spring clips
- Material thickness of mounting surface:
max. 13mm



Base: 1xGU10

Options	Prod. no.
○ white	1000714
● brass	1000716
● chrome	1000715
● grey	1000717



LED GU10 51mm | 6W | 38°
2700K | 450lm | EEK=F
6kWh/1000h

Prod. no.: 1005077



PIKA
DL, round, QPAR51, pivoting

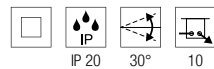
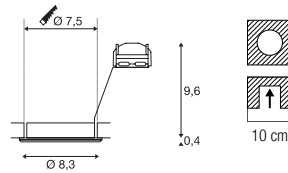

220-240V ~50/60Hz
Material: aluminium

- Spring clips
- Material thickness of mounting surface:
max. 15mm



Base: 1xGU10

Options	Prod. no.
○ white	1000718
● brass	1000720
● chrome	1000719
● grey	1000721



LED GU10 51mm | 6W | 38°
2700K | 450lm | EEK=F
6kWh/1000h

Prod. no.: 1005075



1000719 228

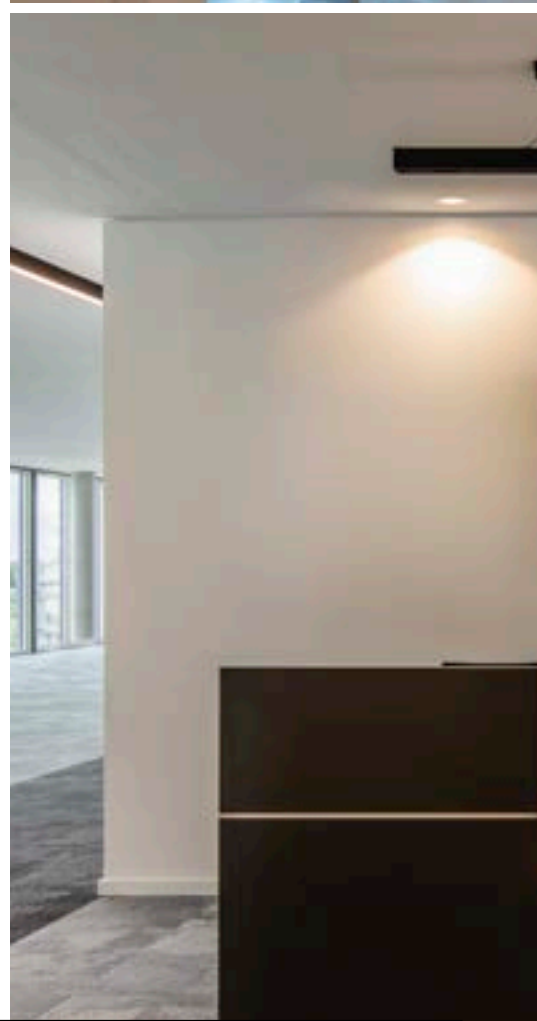
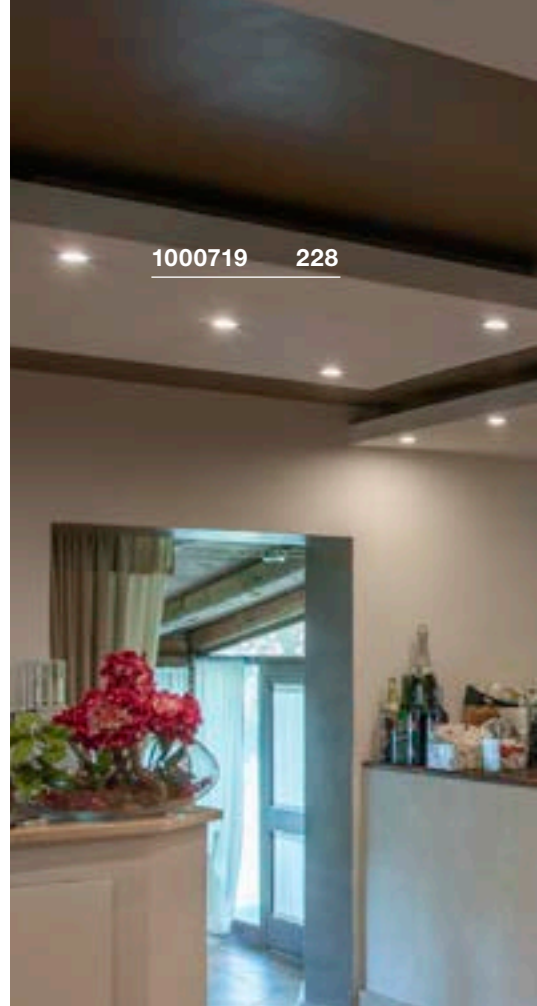



OCULUS
CL, Move, PHASE

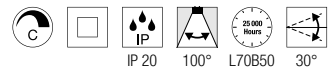
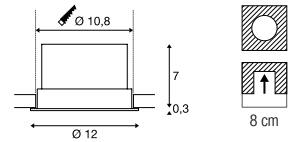

220-240V ~50/60Hz | 250mA
Total wattage: 11W
Material: aluminium/glass

- Spring clips
- Additional frosted lens included
- Material thickness of mounting surface: max. 20mm



Down 36lm | 2000K - 780lm | 3000K

Options	Prod. no.
● black	1004668
○ white	1004669



1004669 229

OCCULDAS 14
EL, indirect, PHASE

OCCULDAS 23
EL, indirect, PHASE

117311 230

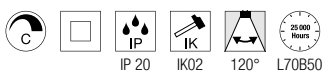
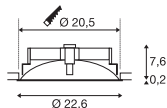
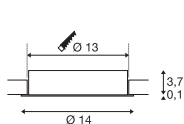

220-240V ~50/60Hz | 350mA
Total wattage: 15W
Material: aluminium/steel

- Spring clips
- Material thickness of mounting surface: max. 20mm



Down 810lm | 3000K



220-240V ~50/60Hz | 700mA
Total wattage: 23W
Material: aluminium/steel

- Spring clips
- Material thickness of mounting surface: max. 30 mm



Down 1500lm | 3000K

Options	Prod. no.
○ white	117331

Options	Prod. no.
○ white	117311





CONTONE®
DL, round, adjustable, PHASE

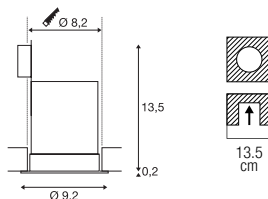

CONTONE®
DL, round, rigid, PHASE

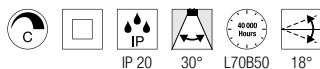
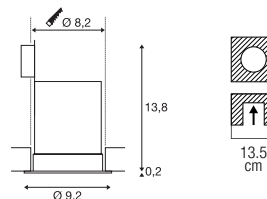

220-240V ~50/60Hz | 350mA
Total wattage: 15W
Material: aluminium

- Spring clips
- Material thickness of mounting surface: max. 25 mm



Down 1000lm | 2000-3000K

Options	Prod. no.
<input type="radio"/> white	161271

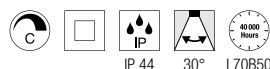

220-240V ~50/60Hz | 350mA
Total wattage: 15W
Material: aluminium

- Spring clips
- Material thickness of mounting surface: max. 25 mm



Down 1000lm | 2000-3000K

Options	Prod. no.
<input type="radio"/> white	161291



161271 231

H-LIGHT
DL, round, PHASE

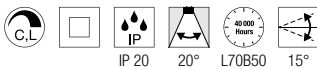
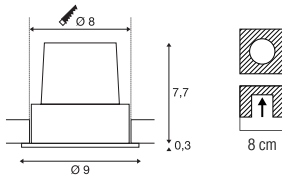

220-240V ~50/60Hz | 500mA
Total wattage: 11W
Material: aluminium

- Spring clips
- Material thickness of mounting surface: max. 30 mm



Down 265lm | 2700K

Options	Prod. no.
● black	114480
○ white	114481

KARPO 30
EL

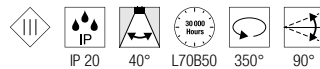
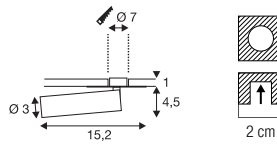

500mA
Total wattage: 7.5W
Material: aluminium/steel

- Material thickness of mounting surface: max. 12mm. When connecting several lights, make sure that they are connected in series!
- Spring clips
- AMP plug included
- Material thickness of mounting surface: max. 12 mm



Down 450lm | 470lm | 3000K

Options	Prod. no.
● black	152380
○ white	152381



Product	Prod. no.
LED driver 20W 350mA/500mA PHASE	
○ white	1007227 ●
LED driver 25W 150-700mA DALI dimmable	
○ white	1007229 ●
LED driver 21W 500mA strain relief included	
○ white	1007226 ●



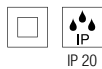
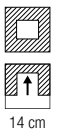
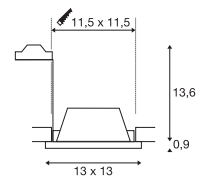
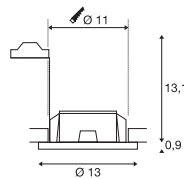

148071 233

PLASTRA
RL, round, QPAR51**PLASTRA**
RL, square, QPAR51

IP 20

220-240V ~50/60Hz
Material: plaster/steel

- Spring clips
- Material thickness of mounting surface: max. 25 mm



Base: 1xGU10

Options	Prod. no.
<input type="radio"/> white	148070

LED GU10 51mm | 6W | 36°
2200-2700K | 360lm | EEK=G
6kWh/1000h

Prod. no.: 1005273



IP 20

220-240V ~50/60Hz
Material: plaster/steel

- Spring clips
- Material thickness of mounting surface: max. 30 mm



Base: 1xGU10

Options	Prod. no.
<input type="radio"/> white	148071

LED GU10 51mm | 6W | 38°
2700K | 450lm | EEK=F
6kWh/1000h

Prod. no.: 1005076

DEKLED
EL

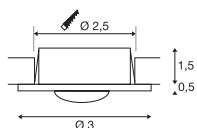

VARU
EL, QPAR51

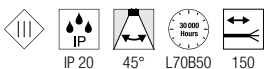
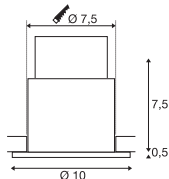

350mA
Total wattage: 1W
Material: aluminium/polycarbonate (PC)

- Spring clips



Down 60lm | 3000K

Options	Prod. no.
● grey	112242

Product	Prod. no.
LED driver 350mA 6W dimmable	
○ white	1002791

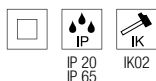

220-240V ~50/60Hz
Material: aluminium/glass

- Spring clips
- Material thickness of mounting surface: max. 15mm



Base: 1xGU10 Max. diameter: 5.1 cm

Options	Prod. no.
● black	1001930
○ white	1001931

Product	Prod. no.
LED GU10 51mm 6W 38°	
2700K 450lm EEK=F	
6kWh/1000h	
Prod. no.: 1005077	

1001931 234



1001931 234





1001165 235



DOLIX OUT
EL, round, QPAR51

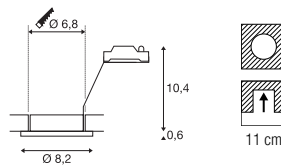

DOLIX OUT
EL, square, QPAR51

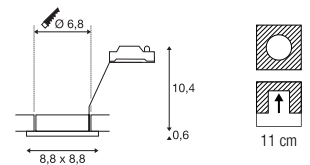

1001166 235

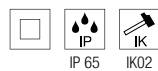

220-240V ~50/60Hz
Material: aluminium/glass

- Spring clips
- Material thickness of mounting surface: max. 20mm



Base: 1xGU10

Options	Prod. no.
○ white	1001165
● silver	1001168
● chrome	1001166
● grey	1001167



LED GU10 51mm | 6W | 36°
2200-2700K | 360lm | EEK=G

Prod. no.: 1005273

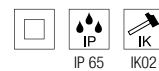

220-240V ~50/60Hz
Material: aluminium/glass

- Spring clips
- Material thickness of mounting surface: max. 20mm



Base: 1xGU10

Options	Prod. no.
○ white	1001169
● silver	1001172
● grey	1001171



LED GU10 51mm | 6W | 36°
2200-2700K | 360lm | EEK=G

Prod. no.: 1005273



1001015 236



KAMUELA ECO EL, round, PHASE

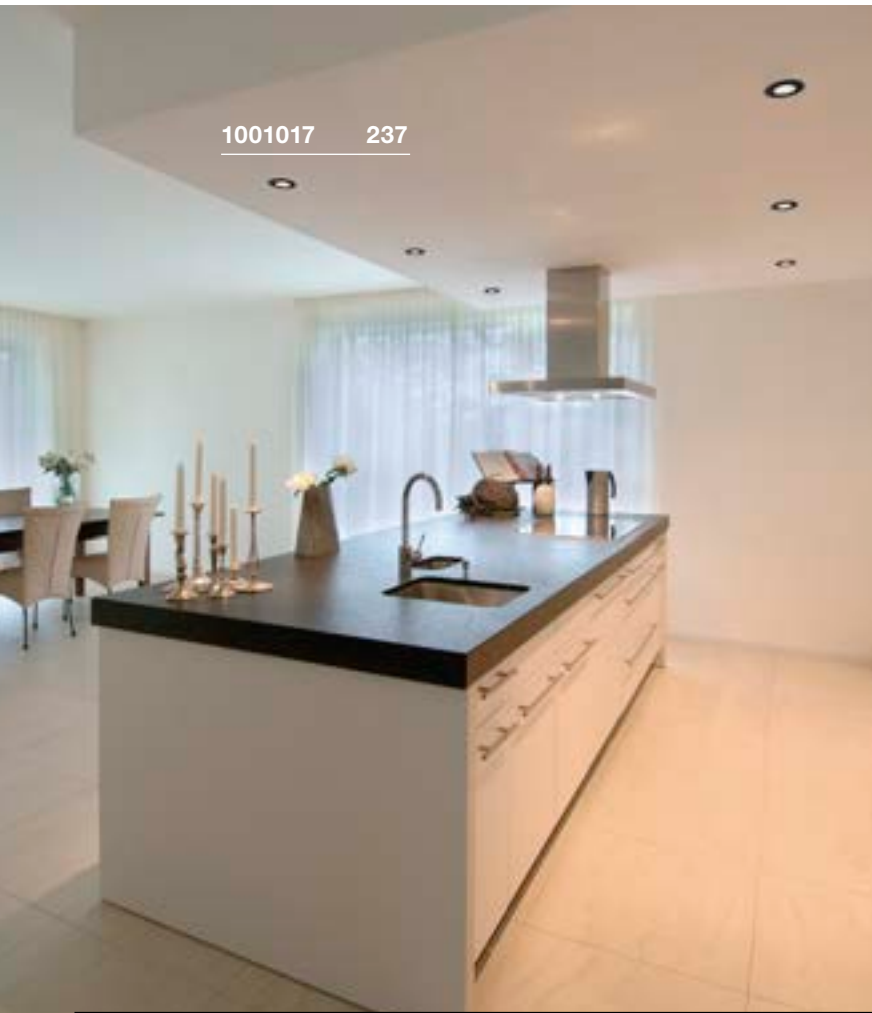
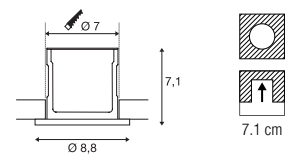

1001017 237

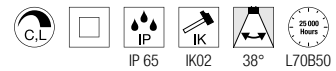

220-240V ~50Hz
Total wattage: 6W
Material: aluminium/plastic

- Spring clips
- Material thickness of mounting surface: max. 40mm
- Fire resistant for at least 90 minutes compliant with BS 476-21



CRI 84

Down

500lm | 3000K

Options	Prod. no.
● black	1001015
○ white	1001016



KAMUELA ECO
EL, round, PHASE

KINI
EL, PHASE

AKALO D83
EL

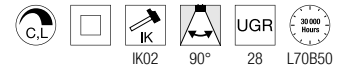
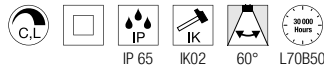
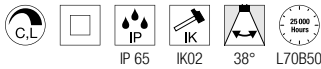
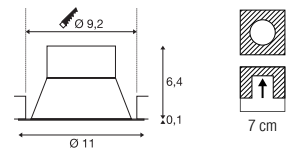
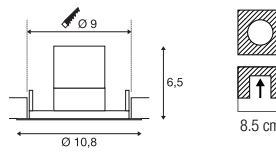
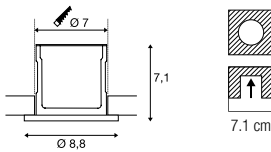

220-240V ~50Hz
Total wattage: 6W
Material: aluminium/plastic

- Spring clips
- Material thickness of mounting surface: max. 40mm
- Fire resistant for at least 90 minutes compliant with BS 476-21

220-240V ~50/60Hz | 260mA
Total wattage: 12W
Material: aluminium/polycarbonate (PC)

- Spring clips
- Material thickness of mounting surface: max. 20mm

220-240V ~50/60Hz | 120mA
Total wattage: 9W
Material: aluminium/polycarbonate (PC)

- Spring clips
- Material thickness of mounting surface: max. 20mm



Down 530lm | 4000K

Down 850lm | 3000K

800lm | 3000K | 880lm | 4000K | 850lm | 5700K

Options	Prod. no.
● black	1001017
○ white	1001018

Options	Prod. no.
○ white	1000833

Options	Prod. no.
○ white	1001264

FRAME BASIC SET RL

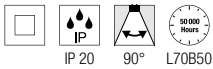
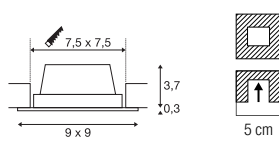

220-240V ~50/60Hz | 350mA
Total wattage: 8.3W
Material: aluminium/acrylic

- Spring clips
- Material thickness of mounting surface: max. 20mm



Down 600lm | 3000K

Options	Prod. no.
● black	112720
○ white	112721

FRAME BASIC RL, HV

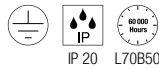
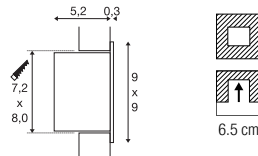

100-240V ~50/60Hz | 350mA
Total wattage: 3W
Material: aluminium

- Material thickness of mounting surface: max. 30 mm



Down 170lm | 2700K

Options	Prod. no.
○ white	1000576
● grey	1000577



Product	Prod. no.
Wall box	
● black	112781
Flush frame	
● gold	112780

FRAME BASIC

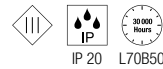
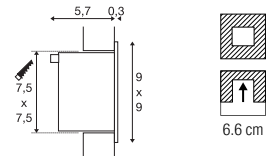

350mA
Total wattage: 1W
Material: aluminium/glass

- When connecting several lights, make sure they are connected in series!
- AMP plug included
- Material thickness of mounting surface: max. 30 mm



Down 40lm | 3000K

Options	Prod. no.
○ white	113262
● grey	111262



Product	Prod. no.
Wall box	
● black	112781
1m cable extension	
○ white	111861
LED driver 3W 350mA inc. AMP socket	
○ white	1007270 ●
Connector strip 3 outlets	
● black	111850
Flush frame	
● gold	112780



1000575 239

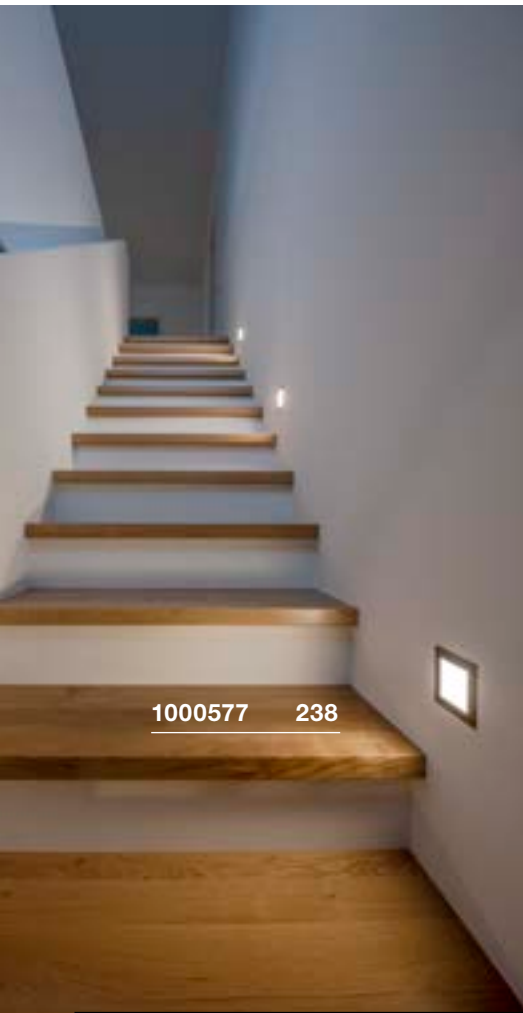

1000577 238

FRAME CURVE EL

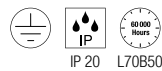
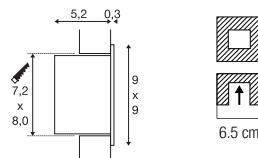

IP 20 L70B50

100-240V ~50/60Hz | 350mA
Total wattage: 3W
Material: aluminium

- Spring clips
- Material thickness of mounting surface: max. 30 mm



Down 140lm | 2700K

Options	Prod. no.
<input type="radio"/> white	1000574
<input checked="" type="radio"/> grey	1000575



Product	Prod. no.
Wall box	
<input checked="" type="radio"/> black	112781
Flush frame	
<input checked="" type="radio"/> gold	112780

FRAME CURVE EL

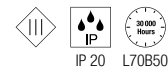
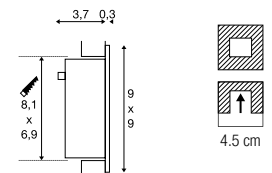

IP 20 L70B50

350mA
Total wattage: 1W
Material: aluminium

- When connecting several lights, make sure they are connected in series!
- Spring clips
- AMP plug included
- Material thickness of mounting surface: max. 25 mm



Down 60lm | 3000K

Options	Prod. no.
<input type="radio"/> white	113292
<input checked="" type="radio"/> grey	111292



Product	Prod. no.
Wall box	
<input checked="" type="radio"/> black	112781
1m cable extension	
<input type="radio"/> white	111861
LED driver 3W 350mA inc. AMP socket	
<input type="radio"/> white	1007270 <input checked="" type="radio"/> yellow
Connector strip 3 outlets	
<input checked="" type="radio"/> black	111850
Flush frame	
<input checked="" type="radio"/> gold	112780

QUAD FRAME 9
WL

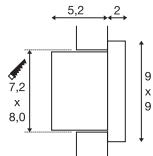

L70B50

100-240V ~50/60Hz | 350mA
Total wattage: 3W
Material: aluminium

- Material thickness of mounting surface:
max. 30 mm



Down 75lm | 3000K

Options	Prod. no.
<input type="radio"/> white	1003466

Product	Prod. no.
Wall box	
<input checked="" type="radio"/> black	112781
Flush frame	
<input checked="" type="radio"/> gold	112780

1003466 240





1002979 241

NOTAPO S RL

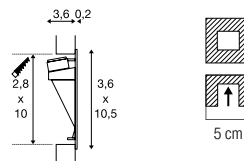

NOTAPO L RL

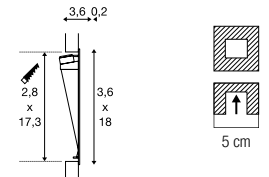

1002980 241

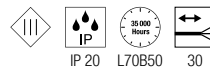

700mA
Power consumption: 2.2W
Material: aluminium

- When connecting several lights, make sure they are connected in series!
- Leaf springs
- Open cable end



Down 6lm | 3000K

Options	Prod. no.
<input type="radio"/> white	1002979



Product	Prod. no.
LED driver 25W 150-700mA DALI dimmable	
<input type="radio"/> white	1007229
LED driver 700mA 3W inc. strain relief	
<input type="radio"/> white	1007216
NOTAPO mounting frame	
<input checked="" type="radio"/> black	1002981

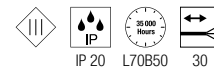

700mA
Power consumption: 2.2W
Material: aluminium

- When connecting several lights, make sure they are connected in series!
- Leaf springs
- Open cable end



Down 6lm | 3000K

Options	Prod. no.
<input type="radio"/> white	1002980



Product	Prod. no.
LED driver 10W 700mA dimmable inc. strain relief	
<input type="radio"/> white	1007213
LED driver 700mA 3W inc. strain relief	
<input type="radio"/> white	1007216
NOTAPO mounting frame	
<input checked="" type="radio"/> black	1002981

DOWNUNDER PUR 80 EL

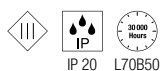
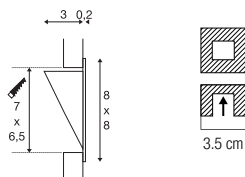

350mA
Total wattage: 3.6W
Material: aluminium/steel

- When connecting several lights, make sure they are connected in series!
- Leaf springs



Down 180lm | 3000K

Options	Prod. no.
<input type="radio"/> white	151950



Product	Prod. no.
Mounting frame	
<input checked="" type="radio"/> grey	151960
1m cable extension	
<input type="radio"/> white	111861
LED driver 3W 350mA inc. AMP socket	
<input type="radio"/> white	1007270 ●
Connector strip 3 outlets	
<input checked="" type="radio"/> black	111850

DOWNUNDER PUR 150 EL

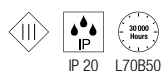
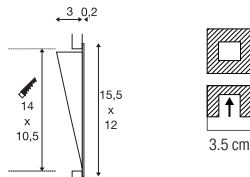

500mA
Total wattage: 5.2W
Material: aluminium/steel

- When connecting several lights, make sure they are connected in series!
- Leaf springs



Down 230lm | 3000K

Options	Prod. no.
<input type="radio"/> white	151952



Product	Prod. no.
Mounting frame	
<input checked="" type="radio"/> grey	151962
LED driver 20W 350mA/500mA PHASE	
<input type="radio"/> white	1007227 ●
LED driver 25W 150-700mA DALI dimmable	
<input type="radio"/> white	1007229 ●
LED driver 21W 500mA strain relief included	
<input type="radio"/> white	1007226 ●

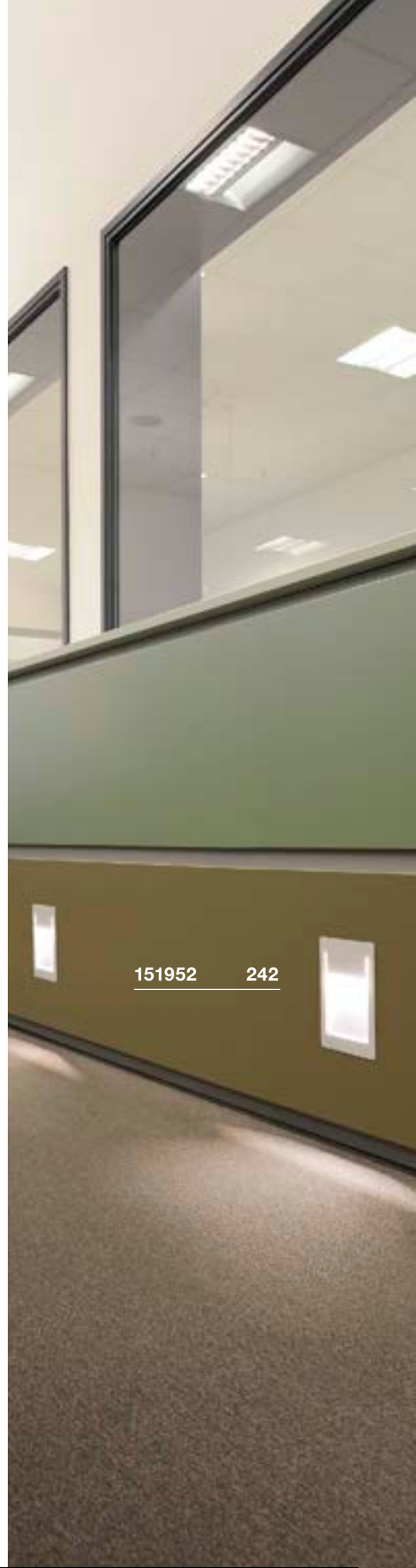

151952

242



MOBALA
EL

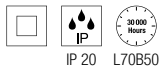
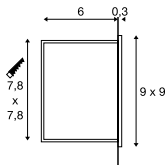

100-240V ~50/60Hz
Total wattage: 1.3W
Material: aluminium

- The mounting frame (1002984) or wall box (1002983) are required for assembly.
- Leaf springs



Down 14lm | 3000K

Options	Prod. no.
<input type="radio"/> white	1002982

⊕

Product	Prod. no.
LED driver 3W 350W	
<input type="radio"/> white	1005248 ●

WORO
EL

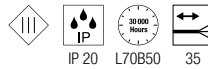
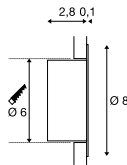

350mA
Total wattage: 1.2W
Material: steel

- When connecting several lights, make sure they are connected in series!
- This item is suitable for installation in cavity walls and flush-mounted sockets for switches/sockets.
- Spring clips
- Open cable end



Down 50lm | 3000K

Options	Prod. no.
<input type="radio"/> white	1002922

⊕

Product	Prod. no.
LED driver 20W 350mA/500mA PHASE	
<input type="radio"/> white	1007227 ●

LED PANEL
620x620mm

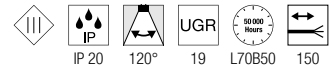
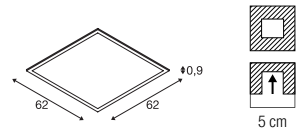

1050mA
Power consumption: 35W
Material: aluminium/polystyrene (PS)

- Open cable end



Down 4000lm | 3000K
4000K

Options	Prod. no.
<input type="radio"/> white	
3000K	1003073
<input type="radio"/> white	
4000K	1003074

⊕

Product	Prod. no.
Suspension kit 1.5m	
<input checked="" type="radio"/> chrome	158799
LED driver 40W 1050mA DALI dimmable with RF interface	
<input type="radio"/> white	1006197 ●
LED driver 40W 1050mA dimmable inc. strain relief	
<input type="radio"/> white	464804
RF module for Dali driver	
<input type="radio"/> white	1006454 ●
RF module for Dali driver	
<input type="radio"/> white	1006199 ●

PATTA-I
EL, round, PHASE

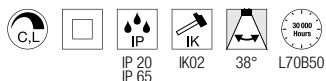
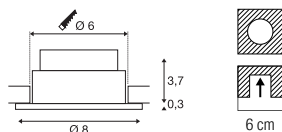

220-240V ~50/60Hz | 350mA
Total wattage: 7.3W
Material: aluminium/glass

- Spring clips Spring clips are included with the product.
- Material thickness of mounting surface: max. 20mm



Down 440lm | 1800-3000K

Options	Prod. no.
● black	1002098
○ white	1002099
● aluminium	1002100

PATTA-I
DL, square, PHASE

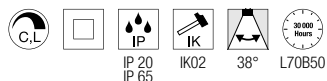
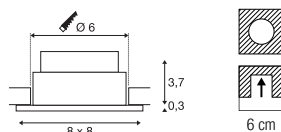

220-240V ~50/60Hz | 350mA
Total wattage: 7.3W
Material: aluminium/glass

- Spring clips Spring clips are included with the product.
- Material thickness of mounting surface: max. 20mm



Down 440lm | 1800-3000K

Options	Prod. no.
● black	1002101
○ white	1002102

1002099 244



1002101 244





1002098 244

PATTA-I
EL, round, PHASE

PATTA-I
EL, square, PHASE

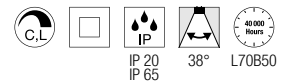
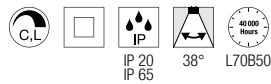
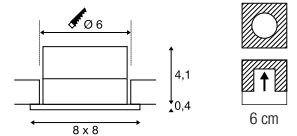
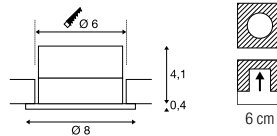

220-240V ~50/60Hz | 500mA
Total wattage: 11W
Material: aluminium/glass

220-240V ~50/60Hz | 500mA
Total wattage: 11W
Material: aluminium/glass

- Spring clips
- Material thickness of mounting surface: max. 25 mm

- Spring clips
- Material thickness of mounting surface: max. 25 mm

114431 245



Down 910lm | 3000K

Down 910lm | 3000K

Options	Prod. no.
● black	114420
○ white	114421
● aluminium	114426

Options	Prod. no.
● black	114430
○ white	114431
● aluminium	114436

114451 247

PATTA-F
EL, round, PHASE

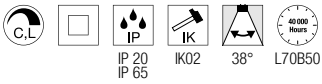
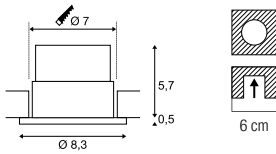

220-240V ~50/60Hz | 500mA
Total wattage: 11W
Material: aluminium/glass

- Spring clips
- Material thickness of mounting surface:
max. 20mm



Down 745lm | 3000K
860lm

Options	Prod. no.
● black 745lm	114440
○ white 860lm	114441



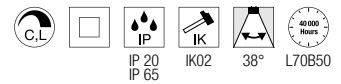
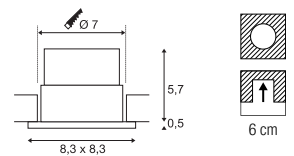

114450 247

PATTA-F
EL, square, PHASE

220-240V ~50/60Hz | 500mA

Total wattage: 11W

Material: aluminium/glass

- Spring clips
- Material thickness of mounting surface:
max. 20mm



Down

745lm | 3000K
860lm

Options	Prod. no.
● black	
745lm	114450
○ white	
860lm	114451





NUMINOS®
can be found
on family pages
102–105

LED



MEDO®
can be found
on family pages
164–165

LED



SCKET
VARYT | 251



LED
Q-LINE® | 253



LED
Q-LINE® | 253



SCKET
TRILEDO | 255



SCKET
TRILEDO | 255



SCKET
TRILEDO | 255



LED
TRILEDO | 257



LED
TRILEDO | 257



LED
TRILEDO | 257



LED
OCULUS | 258



SCKET
ENOLA B | 259



LED
ENOLA C | 259



SCKET
ASTINA | 261



SCKET
NAGY 75 | 261



LED
ANELA | 261



LED
OCCULDAS 13 | 262



LED
OCCULDAS 23 | 262



SCKET
ALTRA DICE | 263



SCKET
ALTRA DICE | 263



SCKET
KARDAMOD | 265



SCKET
KARDAMOD | 265



SCKET
FENDA | 266



LED
FENDA | 267



LED
FENDA | 267



LED
FENDA | 267



SCKET
TENORA | 268



SCKET
SOPRANA | 269



SCKET
PLASTRA | 270



LED
PLASTRA | 271



SCKET
PLASTRA 105 | 271



SCKET
PLASTRA 104 | 271



LED
FERA 25 | 272



LED
FERA 25 | 272



LED
MARONA | 273



LED
PANEL 60 | 274



LED
PANEL | 275



LED
PANEL 60 | 275



LED
PANEL | 275

1007605 251





VARYT CL, E14

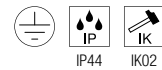
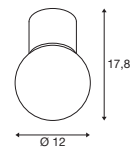

220-240V ~50/60Hz
Material: aluminium

**SOCKET
INSIDE** <6
W

Base: 1xE14

Max. Ø: 3.8 cm

L: 11 cm

Options	Prod. no.
● black	1007607 ●
○ white	1007606 ●
● chrome	1007604 ●
● brass	1007605 ●



C35 | 4.2W | 320°
2700K | 350lm | EEK=G
5kWh/1000h



Prod. no.: 1005285

1000692 253





Q-LINE®
CL, 1m, BAP, PHASE

Q-LINE®
CL, 2m, BAP, PHASE

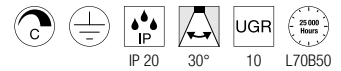
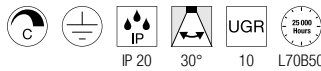
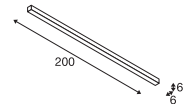
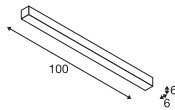

220-240V ~50/60Hz | 900mA
Total wattage: 46W
Material: aluminium/plastic

220-240V ~50/60Hz | 900mA
Total wattage: 93W
Material: aluminium/plastic



Down 2100lm | 3000K
2300lm | 4000K

Down 4200lm | 3000K
4600lm | 4000K

Options	Prod. no.
● black 2100lm 3000K	1000686
○ white 2100lm 3000K	1000685
● black 2300lm 4000K	1000689
○ white 2300lm 4000K	1000688

Options	Prod. no.
● black 4200lm 3000K	1000692
○ white 4200lm 3000K	1000691
● black 4600lm 4000K	1000695
○ white 4600lm 4000K	1000694

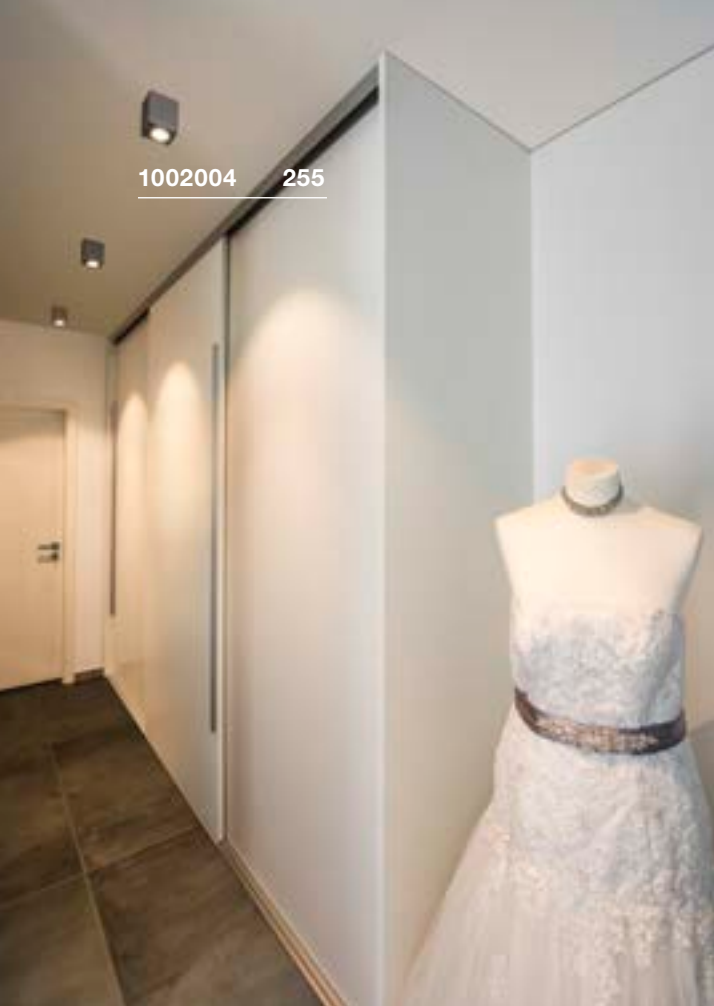

1002004 255



1002011 255



1002005 255



TRILEDO
CL, single, square, QPAR51

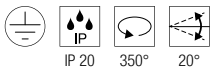
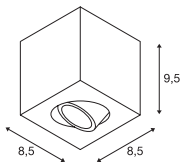

220-240V ~50/60Hz
Material: aluminium



Base: 1xGU10 Max. Ø: 5.1 cm L: 5.5 cm

Options	Prod. no.
● black	1002013
○ white	1002015
● aluminium	1002004



LED GU10 51mm | 6W | 38°
2700K | 450lm | EEK=F
6kWh/1000h



Prod. no.: 1005075

TRILEDO
CL, double, square, QPAR51

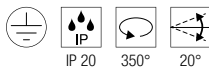
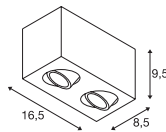

220-240V ~50/60Hz
Material: aluminium



Base: 2xGU10 Max. Ø: 5.1 cm L: 5.5 cm

Options	Prod. no.
● black	1002005
○ white	1002006



LED GU10 51mm | 6W | 38°
2700K | 450lm | EEK=F
6kWh/1000h



Prod. no.: 1005077

TRILEDO
CL, single, round, QPAR51

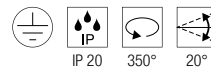
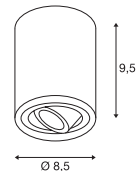

220-240V ~50/60Hz
Material: aluminium



Base: 1xGU10 Max. Ø: 5.1 cm L: 5.5 cm

Options	Prod. no.
● black	1002010
○ white	1002011
● aluminium	1002012



LED GU10 51mm | 6W | 38°
2700K | 450lm | EEK=F
6kWh/1000h



Prod. no.: 1005075

113940 257



113931 257



1002003 257





TRILEDO
CL, single, square

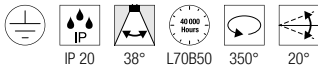
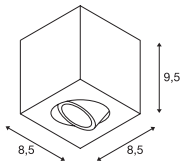

220-240V ~50/60Hz | 350mA
Total wattage: 7.6W
Material: aluminium/aluminium



Down 640lm | 3000K

Options	Prod. no.
● black	113940
○ white	113941

TRILEDO
CL, double, square

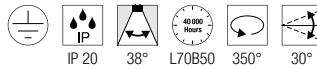
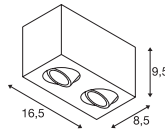

220-240V ~50/60Hz | 350mA
Total wattage: 14W
Material: aluminium



Down 1300lm | 3000K

Options	Prod. no.
● black	1002003
○ white	1002008

TRILEDO
CL, single, round

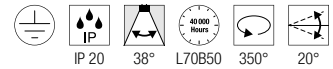
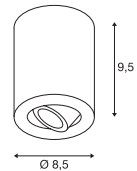

220-240V ~50/60Hz | 350mA
Total wattage: 7.6W
Material: aluminium/aluminium



Down 640lm | 3000K

Options	Prod. no.
● black	113930
○ white	113931

OCULUS
CL, PHASE

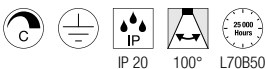
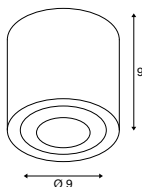

220-240V ~50/60Hz | 250mA
Total wattage: 11W
Material: aluminium/glass

- Additional frosted lens included



Down 36lm | 2000K - 780lm | 3000K

Options	Prod. no.
● black	1004666
○ white	1004667

1004667 258

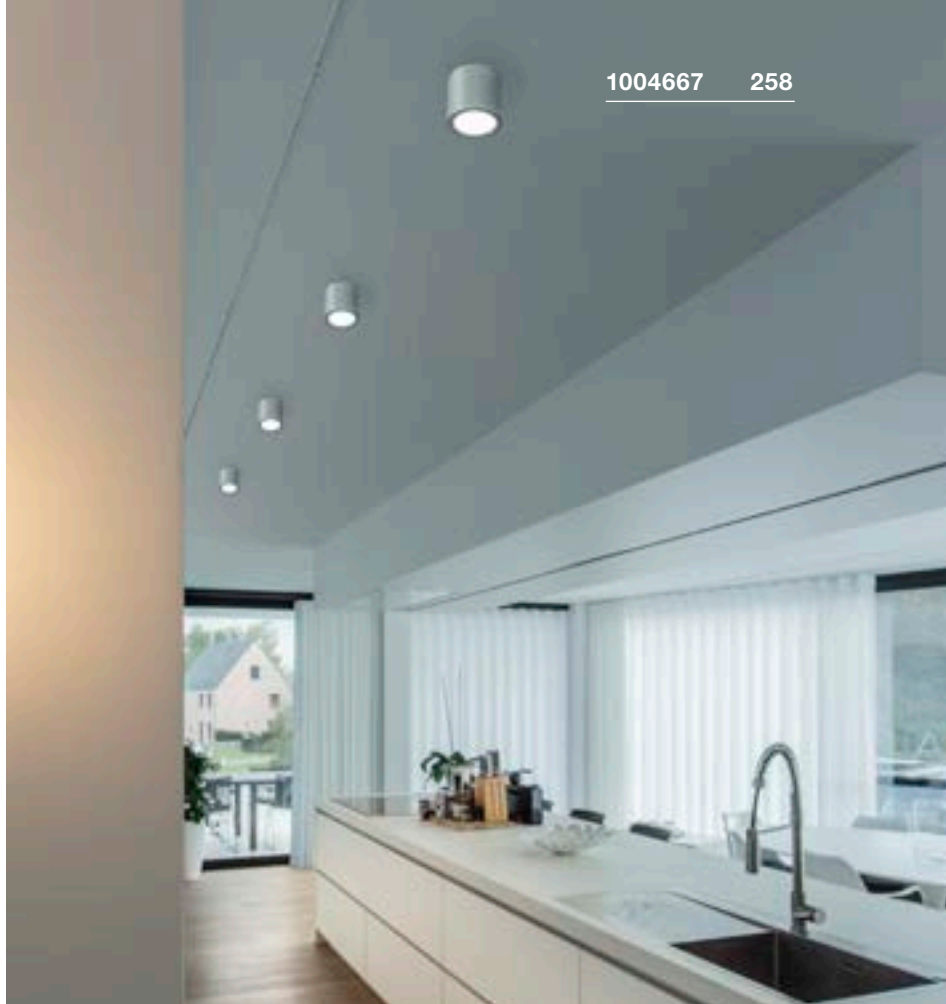

151811 259





ENOLA B
CL, QPAR51

ENOLA C
CL

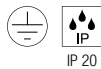
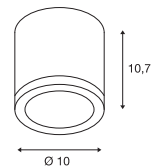
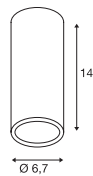

IP 20

220-240V ~50/60Hz
Material: aluminium

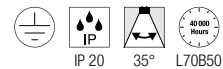

IP 20 35° L70B50

220-240V ~50/60Hz | 500mA
Total wattage: 11W
Material: aluminium



Base: 1xGU10

max. L: 8.5 cm



Down

1020lm | 3000K

Options	Prod. no.
<input checked="" type="radio"/> black	151810
<input type="radio"/> white	151811

Options	Prod. no.
<input type="radio"/> white	152101



LED GU10 51mm | 6W | 36°
2200-2700K | 360lm | EEK=G
6kWh/1000h



Prod. no.: 1005273



Product	Prod. no.
Decorative ring	
<input checked="" type="radio"/> black	151840



1002936 261



1002965 261



1000808 261





ASTINA
CL, QPAR51

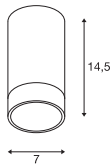

220-240V ~50/60Hz
Material: aluminium



Base: 1xGU10

Options	Prod. no.
● black	1002936
○ white	1002934



LED GU10 51mm | 6W | 38°
2700K | 450lm | EEK=F
6kWh/1000h

Prod. no.: 1005075



NAGY 75
CL, QPAR51

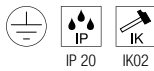
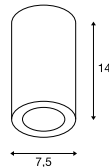

220-240V ~50/60Hz
Material: plaster



Base: 1xGU10

Options	Prod. no.
○ white	1002965



LED GU10 51mm | 6W | 36°
2200-2700K | 360lm | EEK=G
6kWh/1000h

Prod. no.: 1005273



ANELA
CL, PHASE

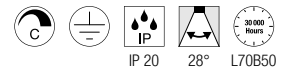
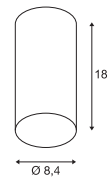

220-240V ~50/60Hz | 500mA
Total wattage: 10W
Material: aluminium



Down 220lm | 3000K | 750lm | 3000K

Options	Prod. no.
● black	1000807
○ white	1000808



Product Reflector 28° Prod. no.

● black	1000811
○ white	1000812
● gold	1000809
● grey	1000810

OCCULDAS 13
CL, indirect, PHASE

OCCULDAS 23
CL, indirect, PHASE

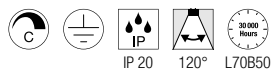
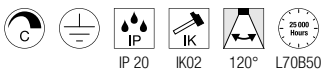
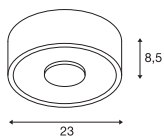
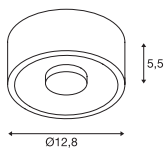

220-240V ~50/60Hz | 350mA
Total wattage: 15W
Material: aluminium

220-240V ~50/60Hz | 700mA
Total wattage: 24 W
Material: aluminium/steel



Down 810lm | 3000K



Down 1500lm | 3000K

Options	Prod. no.
<input type="radio"/> white	117351

Options	Prod. no.
<input type="radio"/> white	117321





ALTRA DICE
CL, QPAR51

ALTRA DICE
CW, double, QPAR51

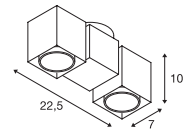
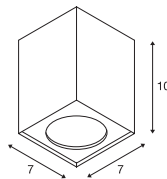

1002215 263

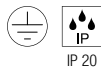

IP 20

220-240V ~50/60Hz
Material: aluminium/steel



Base: 1xGU10

Options	Prod. no.
● black	1002216
○ white	151511
● grey/black	151514



LED GU10 51mm | 6W | 38°
2700K | 450lm | EEK=F
6kWh/1000h

Prod. no.: 1005077

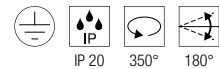

IP 20 350° 180°

220-240V ~50/60Hz
Material: aluminium/steel



Base: 2xGU10

Options	Prod. no.
● black	1002215
○ white	151531
● grey	151534



LED GU10 51mm | 6W | 36°
2200-2700K | 360lm | EEK=G

Prod. no.: 1005273



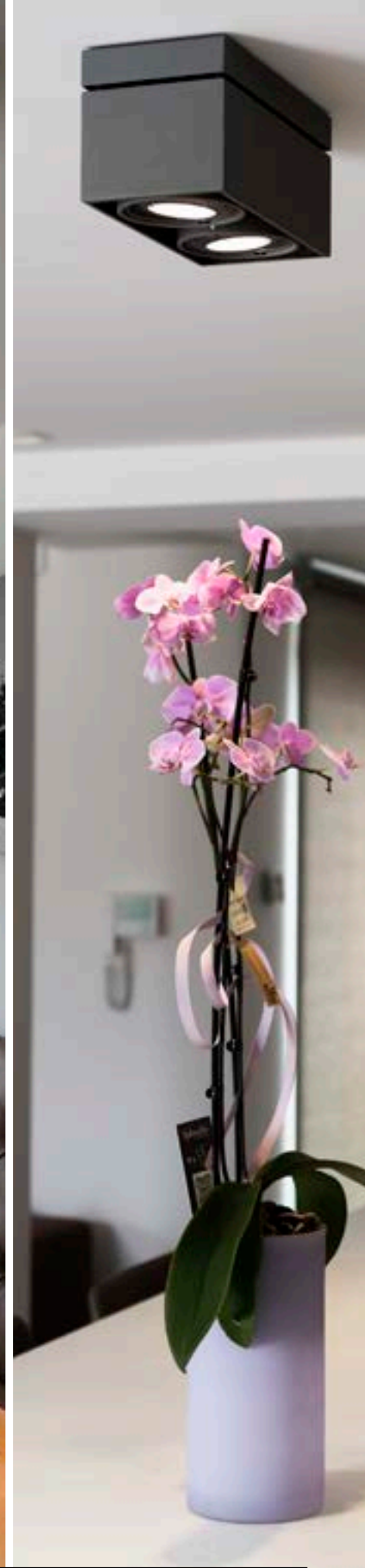



KARDAMOD
CL, single, square, QPAR111

KARDAMOD
CL, double, square, QPAR111

117110 265

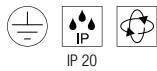
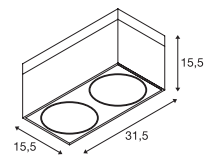
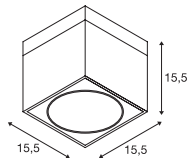

IP 20

220-240V ~50/60Hz
Material: steel



Base: 1xGU10

Options	Prod. no.
● black	117100
○ white	117101



QPAR111 | 12.5W | 30°
2700K | 950lm | EEK=F
13kWh/1000h

Prod. no.: 1005276

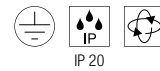

IP 20

220-240V ~50/60Hz
Material: steel



Base: 2xGU10

Options	Prod. no.
● black	117110
○ white	117111



QPAR111 | 8W | 38°
2700K | 680lm | EEK=F
8kWh/1000h

Prod. no.: 1005274



FENDA
Ceiling rosette, E27

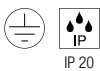
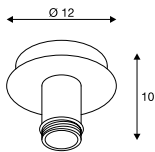

220-240V ~50/60Hz
Material: steel



Base: 1XE27

Options	Prod. no.
● black	155550
○ white	155551



LED E27 | 7.5W | 320°
2700K | 800lm | EEK=F
8kWh/1000h



Prod. no.: 1005268

155551 + 1004775 266 + 267





FENDA

30 cm, round



H: 20 cm
Diameter: 30 cm
Material: textile/steel

Options	Prod. no.
●● black/copper	155592
○ white	155582
● grey	1004774
● beige	155583

FENDA

Ø 45 cm, round



H: 28 cm
Diameter: 45.5 cm
Material: textile/steel

Options	Prod. no.
●● black/copper	156122
○ white	156111
● grey	1004775
● beige	156113

FENDA

Ø 70 cm, round



H: 36 cm
Diameter: 70 cm
Material: textile/steel

- Not suitable for Fenda Bow.

Options	Prod. no.
●● black/copper	1000580
○ white	1000579



156050 268

TENORA CL, E27

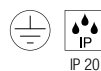
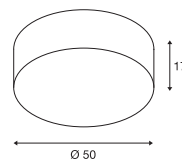

220-240V ~50/60Hz
Material: steel/textile



Base: 3XE27

max. L: 14.8 cm

Options	Prod. no.
● black	156050
○ white	156051



LED E27 | 13.2W | 220°
2700K | 1300lm | EEK=F
13kWh/1000h



Prod. no.: 1005302

**SOPRANA**
CL, E27

155373 269

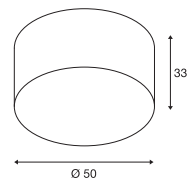
220-240V ~50/60Hz
Material: steel/textile

Base: 3XE27

Options	Prod. no.
● beige	155373

A60 | 7.5W | 320°
2700K | 800lm | EEK=F
8kWh/1000h

Prod. no.: 1005303

148004 270



PLASTRA CL, QPAR51

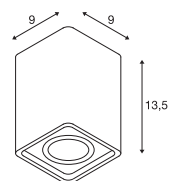

148005 271

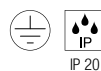

IP 20

220-240V ~50/60Hz
Material: plaster/steel

SOCKET **INSIDE** **<35**
W

Base: 1xGU10

Options	Prod. no.
<input type="radio"/> white	148004



LED GU10 51mm | 6W | 38°
2700K | 450lm | EEK=F
6kWh/1000h



Prod. no.: 1005077



PLASTRA
CL, PHASE

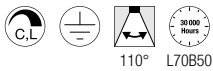
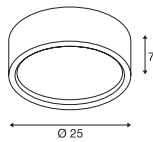

220-240V ~50/60Hz | 350mA
Total wattage: 15W
Material: plaster/glass



Down 990lm | 3000K

Options	Prod. no.
<input type="radio"/> white	148005

PLASTRA 105
CL, E27

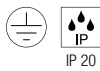
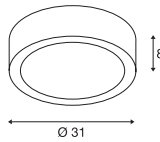

220-240V ~50/60Hz
Material: plaster/glass



Base: 2xE27 Max. Ø: 5.1 cm | L: 14 cm

Options	Prod. no.
<input type="radio"/> white / transparent	148001



LED E27 | 8W | 240°
4000K | 920lm | EEK=E
8kWh/1000h

Prod. no.: 1005290



PLASTRA 104
CL, E27

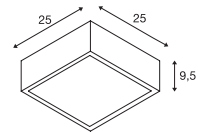

220-240V ~50/60Hz
Material: plaster/glass



Base: 2xE27 Max. Ø: 5.1 cm | L: 14 cm

Options	Prod. no.
<input type="radio"/> white / transparent	148002



LED E27 | 8W | 240°
4000K | 920lm | EEK=E
8kWh/1000h

Prod. no.: 1005290



FERA 25
CL, DALI

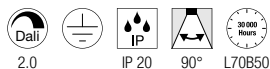
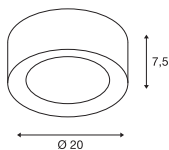

220-240V ~50/60Hz | 500mA
Total wattage: 20W
Material: polycarbonate (PC)/
poly (methyl methacrylate) (PMMA)



Down 1580lm | 3000K | 1650lm | 4000K

Options	Prod. no.
● black	1002968
○ white	1002967

FERA 25
CL

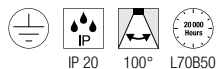
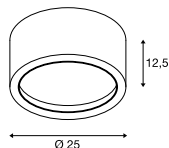

220-240V ~50/60Hz | 550mA
Total wattage: 23W
Material: aluminium/polystyrene (PS)



Down 1800lm | 3000K

Options	Prod. no.
● black	1001939
○ white	161461

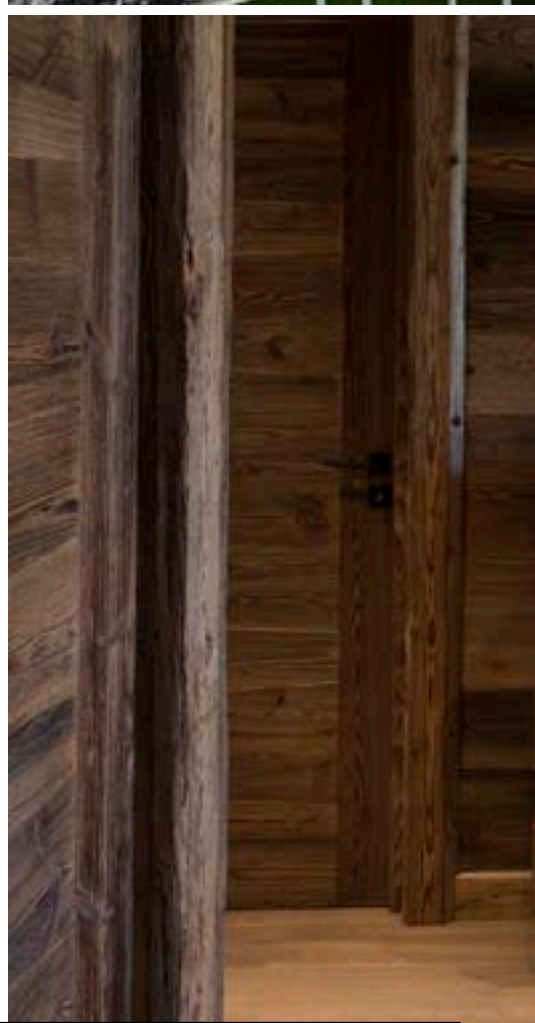
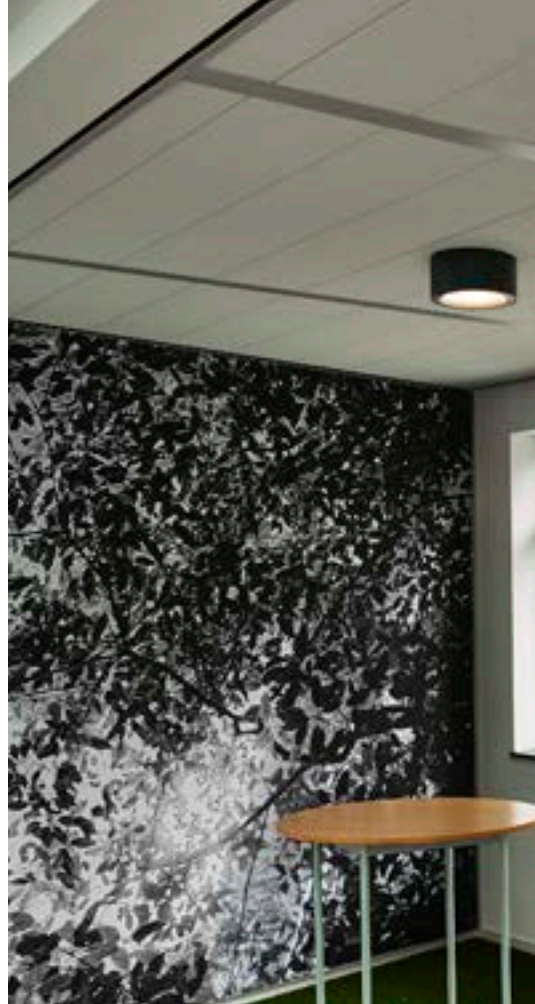



1001939 272

MARONA
CL, PHASE

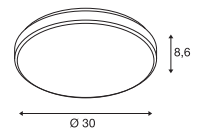

155156 273

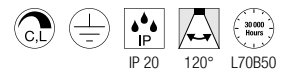

200-240V ~50/60Hz | 430mA
 Total wattage: 15W
 Material: poly (methyl methacrylate) (PMMA)/steel



Down 1200lm | 3000K

Options	Prod. no.
● grey	155156



1000785 274

PANEL 60
CL, round, PHASE

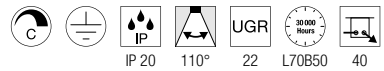
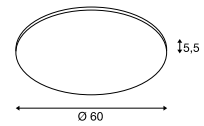

220-240V ~50/60Hz | 1000mA
Total wattage: 42W
Material: aluminium/
poly (methyl methacrylate) (PMMA)



Down 3150lm | 3000K
3350lm | 4000K

Options	Prod. no.
○ white 3150lm 3000K	1000783
○ white 3350lm 4000K	1000784
● grey 3150lm 3000K	1000785
● grey 3350lm 4000K	1000786



PANEL
CL, 1200x300mm, PHASE

PANEL 60
CL, round, DALI

PANEL
CL, 1200x300mm, DALI

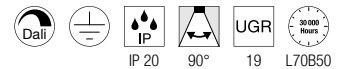
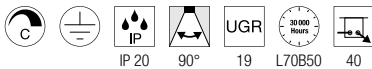
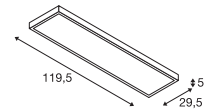
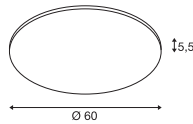
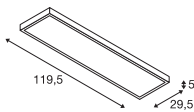

220-240V ~50/60Hz | 1000mA
Total wattage: 45W
Material: aluminium/plastic

120-277V ~50/60Hz | 1000mA
Total wattage: 43W
Material: aluminium/
poly (methyl methacrylate) (PMMA)

120-277V ~50/60Hz | 1000mA
Total wattage: 43W
Material: aluminium/
poly (methyl methacrylate) (PMMA)



Down 3100lm | 3000K
3400lm | 4000K

Down 3150lm | 3000K
3350lm | 4000K

Down 3100lm | 3000K
3400lm | 4000K

Options	Prod. no.
○ white	
3100lm 3000K CRI80	1001505
○ white	
3400lm 4000K CRI80	1001506
● grey	
3100lm 3000K CRI80	1001508
● grey	
3400lm 4000K CRI90	1001509

Options	Prod. no.
○ white	
3150lm 3000K	1003040
○ white	
3350lm 4000K	1003041
● grey	
3150lm 3000K	1003042
● grey	
3350lm 4000K	1003043

Options	Prod. no.
○ white	
3100lm 3000K	1003052
○ white	
3400lm 4000K	1003053
● grey	
3100lm 3000K	1003054
● grey	
3400lm 4000K	1003055



SCKET
PANTILO
ROPE 19 | 279



SCKET
PANTILO
ROPE 20 | 279



SCKET
PANTILO
ROPE 27 | 279



SCKET
PANTILO OVAL | 281



SCKET
PANTILO 20 | 281



SCKET
PANTILO 28 | 281



SCKET
PANTILO
CONVEX 29 | 283



SCKET
PANTILO
CONVEX 40 | 283



SCKET
ASTO TUBE | 285



SCKET
ASTO TUBE | 285



SCKET
ASTO TUBE | 285



SCKET
ASTO TUBE | 285



LED
WORKLIGHT
PRO 120 | 287



LED
WORKLIGHT
PRO 150 | 287



LED
WORKLIGHT | 288



LED
I-PENDANT PRO | 289



LED
PANEL 60 | 289



LED
NOYA | 290



LED
GLENOS® | 291



LED
GLENOS® | 291



LED
Q-LINE® | 293



LED
Q-LINE® | 293



LED
Q-LINE® | 293



LED
OCULUS | 294



SCKET
FITU | 295



SCKET
FENDA | 296



FENDA | 296



FENDA | 296



FENDA | 297



FENDA | 297



FENDA | 297



HELIA
AMBIENT 35 | 300



HELIA
AMBIENT 35 | 300



HELIA 30 | 301



HELIA 30 | 301



HELIA 40 | 303



HELIA 40 | 303



ASTINA | 305



ENOLA B | 305



ENOLA | 305



ANELA | 306



LISENNE | 306



TONGA® | 307



QUADRASS | 307



PARA CONE GL | 309



PARA CONE 20 | 309



PARA CONE 30 | 309



PHELIA 10 | 310



PHELIA 20 | 311



PHELIA 25 | 311



PHELIA 30 | 311



FORCHINI 50 | 312



FORCHINI 70 | 312



FORCHINI M 40 | 313



FORCHINI M 50 | 313



LIGHT EYE® 90 | 314



LIGHT EYE® 150 | 314



SUN / BIG SUN | 315



ROTOBALL 25 | 317



ROTOBALL 40 | 317



ROTOBALL 50 | 317



PARA DOME | 318



PARA DOME | 318



PARA DOME | 318



PARA 380 | 319



1007588 279

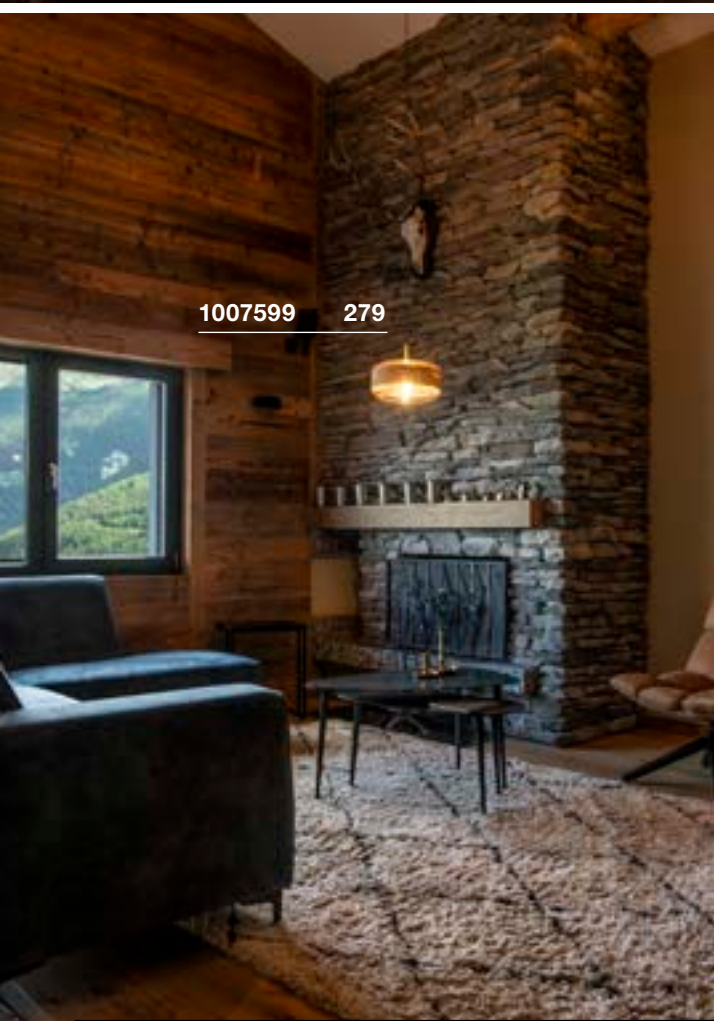

1007599 279



1007597 279



PANTILO ROPE 19 PD, E27

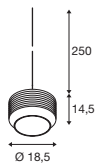

200-240V ~50/60Hz
Material: glass/steel/hemp

- Open cable end

SOCKET INSIDE <15 W

Base: 1xE27 Max. Ø: 10 cm L: 11 cm

Options	Prod. no.
● amber/gold	1007597
● anthracite/silver	1007596

A60 | 7.5W | 180°
 2700K | 720lm | EEK=F
 8kWh/1000h

Prod. no.: 1005305

+

Product	Prod. no.
1-phase adapter	
● black	143120
○ white	143121
● grey	143124
3-phase light adapter	
● black	145990
● grey	145994
○ white	1001542
Fitu single ceiling rose, round	
● black	132600
○ white	132601
● gold	1002163
● chrome	132605

PANTILO ROPE 20 PD, E27

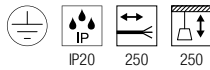
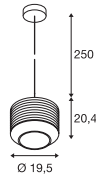

200-240V ~50/60Hz
Material: glass/steel/hemp

SOCKET INSIDE <15 W

Base: 1xE27 Max. Ø: 10 cm L: 18 cm

Options	Prod. no.
● amber/gold	1007589
● anthracite/silver	1007588

A60 | 7.5W | 180°
 2700K | 720lm | EEK=F
 8kWh/1000h

Prod. no.: 1005305

PANTILO ROPE 27 PD, E27

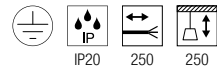
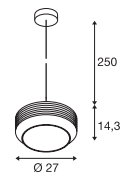

200-240V ~50/60Hz
Material: glass/steel/hemp

SOCKET INSIDE <15 W

Base: 1xE27 Max. Ø: 15 cm L: 11 cm

Options	Prod. no.
● amber/gold	1007599
● anthracite/silver	1007598

A60 | 7.5W | 180°
 2700K | 720lm | EEK=F
 8kWh/1000h

Prod. no.: 1005305

1006403 281





PANTILO OVAL PD, E27

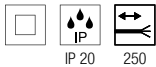
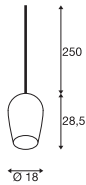

200-240V ~50/60Hz
Material: glass

- Open cable end



Base: 1xE27

Options	Prod. no.
<input type="radio"/> white	1006402
<input type="radio"/> gold	1006403
<input type="radio"/> chrome	1006398
<input type="radio"/> copper	1006400



A60 | 7.5W | 180°
2700K | 720lm | EEK=F
8kWh/1000h



Prod. no.: 1005305



Product	Prod. no.
1-phase adapter	
<input checked="" type="radio"/> black	143120
<input type="radio"/> white	143121
<input type="radio"/> grey	143124
3-phase light adapter	
<input checked="" type="radio"/> black	145990
<input type="radio"/> grey	145994
<input type="radio"/> white	1001542
Surface-mounted ceiling rose	
<input checked="" type="radio"/> black	1004744
<input type="radio"/> white	1004745
<input type="radio"/> chrome	1004746
FITU single ceiling rose	
<input type="radio"/> white	132601
<input type="radio"/> gold	1002163
FITU single ceiling rose, round	
<input checked="" type="radio"/> black	132600
<input type="radio"/> chrome	132605

PANTILO 20 PD, E27

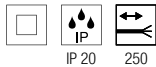
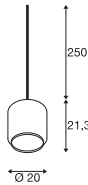

200-240V ~50/60Hz
Material: glass

- Open cable end



Base: 1xE27

Options	Prod. no.
<input type="radio"/> white	1006396
<input type="radio"/> gold	1006395
<input type="radio"/> chrome	1003004
<input type="radio"/> copper	1003005



A60 | 7.5W | 180°
2700K | 720lm | EEK=F
8kWh/1000h



Prod. no.: 1005305



Product	Prod. no.
1-phase adapter	
<input checked="" type="radio"/> black	143120
<input type="radio"/> white	143121
<input type="radio"/> grey	143124
3-phase light adapter	
<input checked="" type="radio"/> black	145990
<input type="radio"/> grey	145994
<input type="radio"/> white	1001542
FITU single ceiling rose	
<input type="radio"/> white	132601
<input type="radio"/> gold	1002163
FITU single ceiling rose, round	
<input checked="" type="radio"/> black	132600
<input type="radio"/> chrome	132605

PANTILO 28 PD, E27

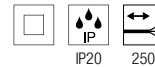
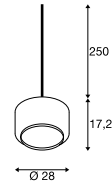

200-240V ~50/60Hz
Material: glass

- Open cable end



Base: 1xE27

Options	Prod. no.
<input type="radio"/> white	1006399
<input type="radio"/> gold	1006397
<input type="radio"/> chrome	1003006
<input type="radio"/> copper	1003007



A60 | 7.5W | 180°
2700K | 720lm | EEK=F
8kWh/1000h



Prod. no.: 1005305



Product	Prod. no.
1-phase adapter	
<input checked="" type="radio"/> black	143120
<input type="radio"/> white	143121
<input type="radio"/> grey	143124
3-phase light adapter	
<input checked="" type="radio"/> black	145990
<input type="radio"/> grey	145994
<input type="radio"/> white	1001542
FITU single ceiling rose	
<input type="radio"/> white	132601
<input type="radio"/> gold	1002163
FITU single ceiling rose, round	
<input checked="" type="radio"/> black	132600
<input type="radio"/> chrome	132605



1003443 283



PANTILO CONVEX 29 PD, E27

PANTILO CONVEX 40 PD, E27

1003444 283

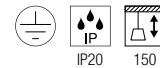
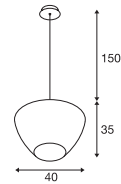
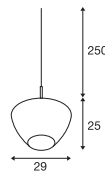

220-240V ~50/60Hz
Material: glass/steel

220-240V ~50/60Hz
Material: glass/steel

- Open cable end

SOCKET INSIDE 40 W

SOCKET INSIDE 40 W

Base: E27 | Max. Ø: 10 cm | L: 20 cm

Base: E27 | Max. Ø: 15 cm | L: 30 cm

Options	Prod. no.
● chrome	1003443

Options	Prod. no.
● chrome	1003444

A60 | 7.5W | 180°
 2700K | 720lm | EEK=F
 8kWh/1000h

Prod. no.: 1005305

A60 | 7.5W | 180°
 2700K | 720lm | EEK=F
 8kWh/1000h

Prod. no.: 1005305

⊕

Product	Prod. no.
1-phase adapter	
● black	143120
○ white	143121
● grey	143124
3-phase light adapter	
● black	145990
● grey	145994
○ white	1001542
FITU single ceiling rose	
○ white	132601
● gold	1002163
FITU single ceiling rose, round	
● black	132600
● chrome	132605

1006438 285





ASTO TUBE

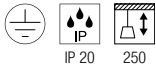

220-240V ~50/60Hz
Material: aluminium



Base: 1xGU10



LED GU10 51mm | 6W | 36°
2200-2700K | 360lm | EEK=G
6kWh/1000h



Prod. no.: 1005273

ASTO TUBE PD, single, GU 10

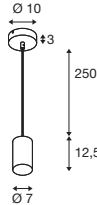

Options	Prod. no.
● black	1006431
○ white	1006432

ASTO TUBE PD, double, GU 10

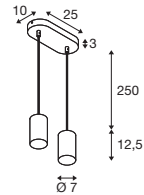

Options	Prod. no.
● black	1006433
○ white	1006434

ASTO TUBE Decorative reflector



H: 3.95 cm
Diameter: 6.75 cm
Material: polycarbonate (PC)

ASTO TUBE PD, triple, GU 10

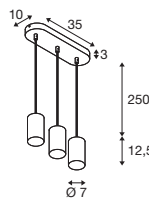

Options	Prod. no.
● black	1006435
○ white	1006436

ASTO TUBE PD, quadruple, GU 10

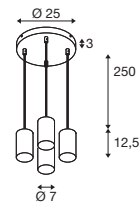

Options	Prod. no.
● black	1006437
○ white	1006438

Options	Prod. no.
● black/chrome	1007190
● gold	1006450
● chrome	1006449
● copper	1006451





WORKLIGHT PRO 120 PD, DALI

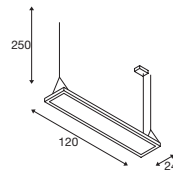

200-240V ~50/60Hz | 1200mA
 Total wattage: 50W
 Material: aluminium/steel



Up 2800lm | 4000K
 Down 3300lm

Options	Prod. no.
● black	1007468 ●
○ white	1007469 ●
● grey	1007470 ●

WORKLIGHT PRO 150 PD, DALI

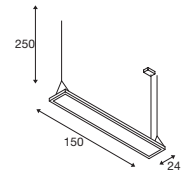

200-240V ~50/60Hz | 1400mA
 Total wattage: 59W
 Material: aluminium/steel



Up 3300lm | 4000K
 Down 3900lm

Options	Prod. no.
● black	1007471 ●
○ white	1007472 ●
● grey	1007473 ●

WORKLIGHT PD, DALI



NEW

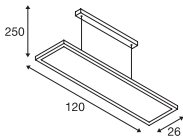

200-240V ~50/60Hz | 1550mA
 Total wattage: 57W
 Material: aluminium



Up 2000lm | 4000K
 Down 3000lm

Options	Prod. no.
● black	1005395
○ white	1005396
○ silver	1006345 ●

1006345 288





I-PENDANT PRO
PD, 1195x295mm, DALI

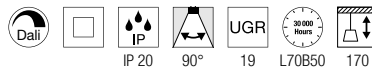
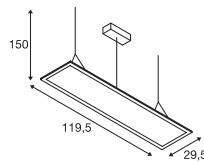

120-277V ~50/60Hz | 1000mA
Total wattage: 43W
Material: aluminium/
poly (methyl methacrylate) (PMMA)



Down 3750lm | 3000K
3800lm | 4000K

Options	Prod. no.
○ white 3750lm 3000K	1003048
○ white 3800lm 4000K	1003049
● grey 3750lm 3000K	1003050
● grey 3800lm 4000K	1003051



PANEL 60
PD, round, DALI

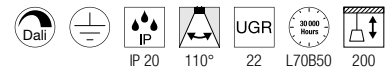
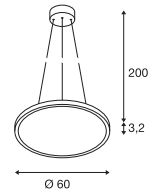

120-277V ~50/60Hz | 1000mA
Total wattage: 43W
Material: aluminium/
poly (methyl methacrylate) (PMMA)



Down 3150lm | 3000K
3350lm | 4000K

Options	Prod. no.
○ white 3150lm 3000K	1003044
○ white 3350lm 4000K	1003045
● grey 3150lm 3000K	1003046
● grey 3350lm 4000K	1003047



NOYA
PD, PHASE

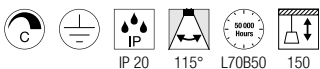
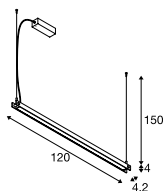

220-240V ~50/60Hz | 700mA
Total wattage: 32W
Material: aluminium/polycarbonate (PC)



Down 1861lm | 2700K | 2025lm | 3000K

Options	Prod. no.
● black	1003530
○ white	1003532





1001403 291

GLENOS®
PD, 1m, 1-10V

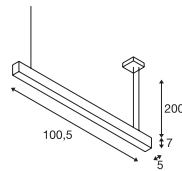

GLENOS®
PD, 2m, 1-10V

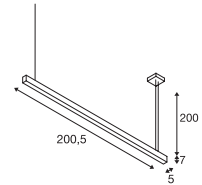

1001409 291

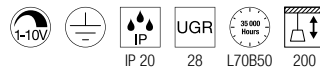

220-240V ~50/60Hz | 1000mA
Total wattage: 43W
Material: aluminium/plastic



Down 2850lm | 3000K
3300lm | 4000K

Options	Prod. no.
● black 2850lm 3000K	1001400
● black 3300lm 4000K	1001403

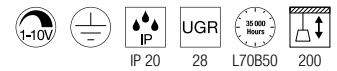

220-240V ~50/60Hz | 1000mA
Total wattage: 85W
Material: aluminium/plastic



Down 5700lm | 3000K
6600lm | 4000K

Options	Prod. no.
● black 5700lm 3000K	1001406
● black 6600lm 4000K	1001409



1000933 293

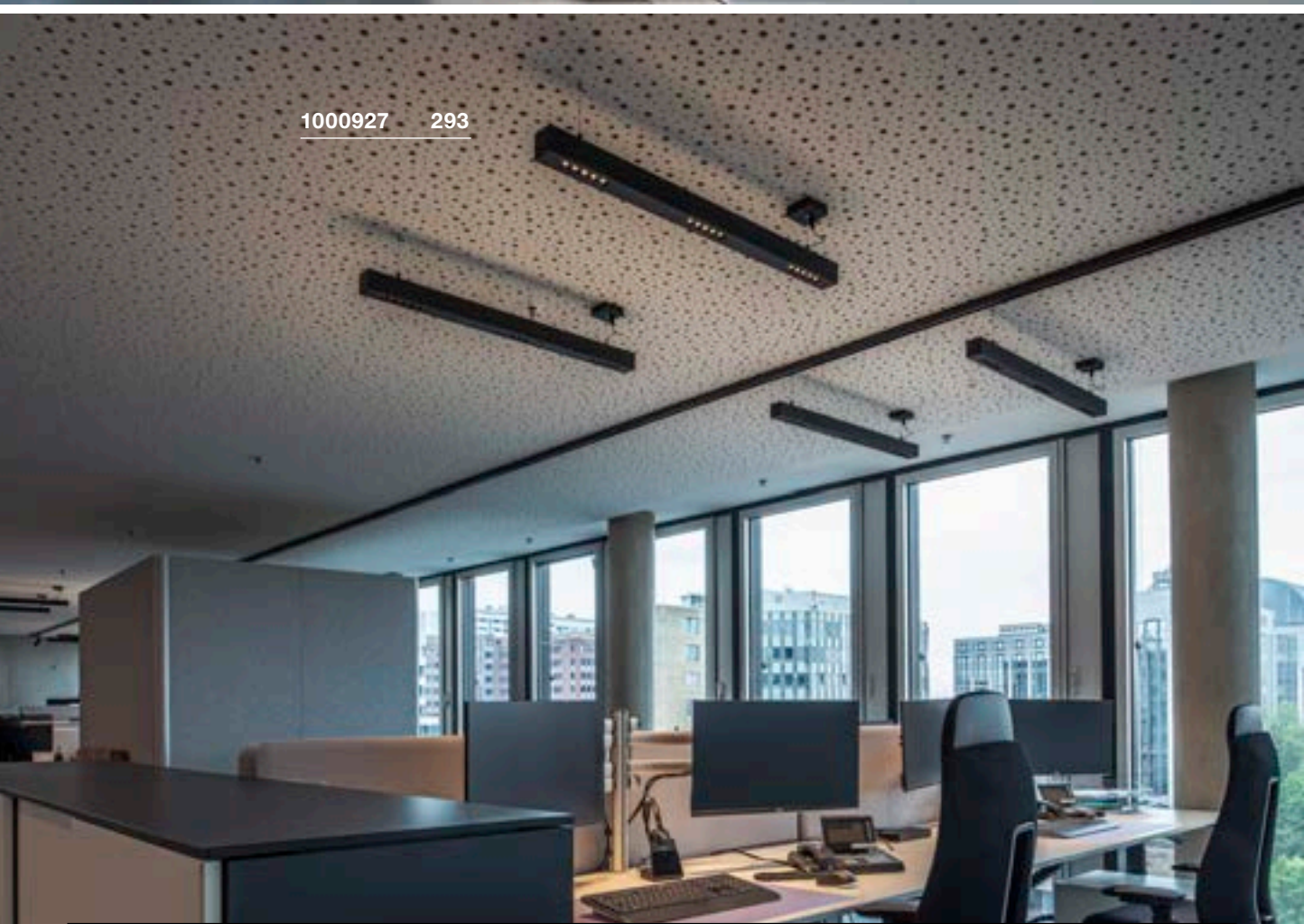

1000927 293



Q-LINE®
PD, 1m, BAP, PHASE

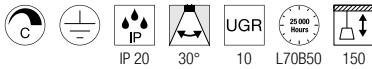
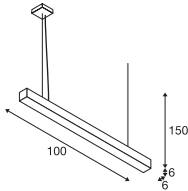

220-240V ~50/60Hz | 900mA
Total wattage: 46W
Material: aluminium/plastic



Down 2100lm | 3000K
2300lm | 4000K

Options	Prod. no.
● black 2100lm 3000K	1000927
● black 2300lm 4000K	1000933
○ white 2100lm 3000K	1000926
○ white 2300lm 4000K	1000932

Q-LINE®
PD, 2m, BAP, PHASE

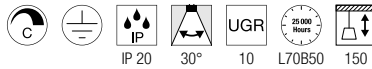
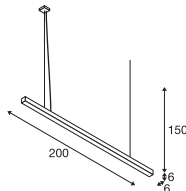

220-240V ~50/60Hz | 900mA
Total wattage: 93W
Material: aluminium/plastic



Down 4200lm | 3000K
4600lm | 4000K

Options	Prod. no.
● black 4200lm 3000K	1000930
● black 4600lm 4000K	1000936
○ white 4200lm 3000K	1000929
○ white 4600lm 4000K	1000935

Q-LINE®
PD, DALI, single

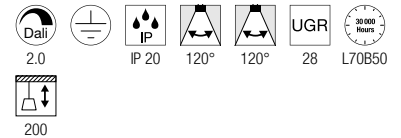
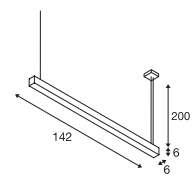

220-240V ~50/60Hz | 700mA
Total wattage: 47W
Material: aluminium/acrylic



Down 3700lm | 3000K

Options	Prod. no.
● black	1001309
○ white	1001310

OCULUS
PD, single, PHASE

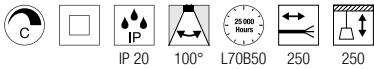
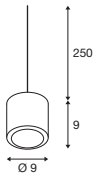

220-240V ~50/60Hz | 250mA
Total wattage: 11W
Material: aluminium/glass

- Additional frosted lens included
- Matching accessories can be found on page 295
- Open cable end



Down 36lm | 2000K - 780lm | 3000K

Options	Prod. no.
● black	1004672
○ white	1004673

1004672 294



132690 295

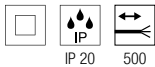
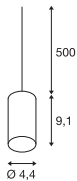

FITU
PD, E27

220-240V ~50/60Hz
Material: aluminium

- Textile cable
- Matching accessories can be found on page 295
- Open cable end



Base: 1xE27

Options	Prod. no.
● black	132690
○ white	132691



A60 | 7.5W | 320°
2700K | 800lm | EEK=F
8kWh/1000h



Prod. no.: 1005303

Fitu single ceiling rose, round

16A max.
Steel
H: 3.9 cm
Diameter: 8.5 cm
Strain relief included



Options	Prod. no.
● black	132600
○ white	132601
● gold	1002163
● chrome	132605

Fitu set of 3 ceiling roses, round

16A max.
Steel
H: 5.4 cm
Diameter: 22 cm
Strain relief included



Options	Prod. no.
● black	132610
○ white	132611

Surface-mounted ceiling rose

16A max.
Steel
H: 2.6 cm
Diameter: 9 cm



Options	Prod. no.
● black	1004744
○ white	1004745
● gold	1006377
● chrome	1004746

Recessed ceiling rose

16A max.
Steel/polyamide 66 (PA 66)
H: 3.3 cm
Diameter: 8.5 cm



Options	Prod. no.
● black	1004674
○ white	1004675
● gold	1006378
● chrome	1004676

Ceiling hook

Aluminium
L: 4.6 cm
Diameter: 1.8 cm



Options	Prod. no.
● black	132670
○ white	132671

1-phase adapter

6A max.
Polycarbonate (PC)
L: 8.5 cm W: 3.5 cm H: 3.2 cm
max. mech. load 2 kg



Options	Prod. no.
● black	143120
○ white	143121
● grey	143124

3-phase light adapter

10A max.
plastic
L: 9.6 cm W: 3.5 cm H: 4.5 cm
max. mech. Load 5 kg



Options	Prod. no.
● black	145990
○ white	1001542
● grey	145994

Cable hook

Aluminium
L: 3.1 cm
Diameter: 1.4 cm



Options	Prod. no.
● black	132680
○ white	132681

FENDA
PD, E27



FENDA
Glass shade



H: 20 cm
Diameter: 12.5 cm
Material: glass

FENDA
15 cm, round



H: 40 cm
Diameter: 15 cm
Material: textile/steel

Options	Prod. no.
● brown	1000773

Options	Prod. no.
●● black/copper	156152
○ white	156141
● grey	1004773
● beige	156143

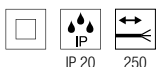
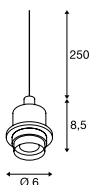

220-240V ~50/60Hz
Material: steel/plastic

- Matching accessories can be found on page 295
- Open cable end



Base: 1xE27

Options	Prod. no.
● black	132660
○ white	132661
● chrome	132662



A60 | 7.5W | 320°
2700K | 800lm | EEK=F
8kWh/1000h



Prod. no.: 1005303





FENDA
30 cm, round



H: 20 cm
Diameter: 30 cm
Material: textile/steel

Options	Prod. no.
● black/copper	155592
○ white	155582
● grey	1004774
● beige	155583

FENDA
Ø 45 cm, round



H: 28 cm
Diameter: 45.5 cm
Material: textile/steel

Options	Prod. no.
● black/copper	156122
○ white	156111
● grey	1004775
● beige	156113



Product	Prod. no.
Acrylic glass cover	156100

FENDA
Ø 70 cm, round



H: 36 cm
Diameter: 70 cm
Material: textile/steel

• Not suitable for Fenda Bow.

Options	Prod. no.
● black/copper	1000580
○ white	1000579



Product	Prod. no.
Acrylic glass cover	1000957

155561 + 1000579 296 + 297



MIX & MATCH FENDA

FENDA Ø15

Black	156152
White	156141
Beige	156143
Grey	1004773



FENDA Ø30

Black	155592
White	155582
Beige	155583
Grey	1004774



FENDA Ø45

Black	156122
White	156111
Beige	156113
Grey	1004775

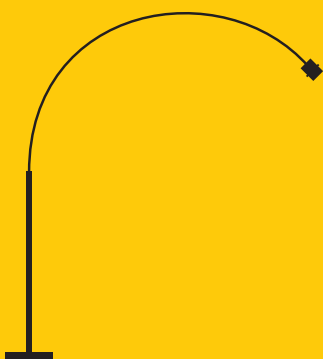

FENDA BOW

Black	1003029
Chrome	1000763



FENDA TL

Black	155780
-------	--------



FENDA FL

Black	155790
-------	--------



FENDA TL

Black	155540
-------	--------



FENDA FL

Black	155490
-------	--------

Combine the SLV Mix & Match products to suit your taste. Designed to work perfectly together, you can mix and match within the FENDA family or even combine the FENDA and FITU product families. You can recognise SLV Mix & Match products by the following symbol:



MIX
match

FENDA Ø70

Black | 1000580
White | 1000579

FENDA Ø12,5

Glass Shade

Brown | 1000773

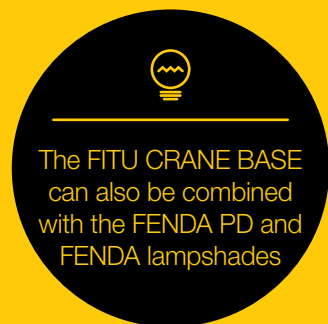
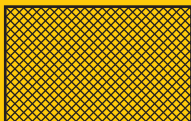

FENDA PD

Black | 132660
White | 132661
Chrome | 132662

FENDA CL

Black | 155550
White | 155551

FITU CRANE BASE

Black | 1004682



FITU PD

Black | 132690
White | 132691

HELIA AMBIENT 35 PD, PHASE

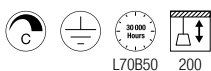
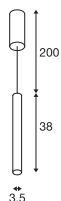
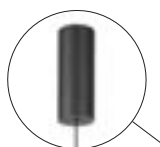

220-240V ~50/60Hz | 500mA
Total wattage: 9W
Material: aluminium/acrylic



Down 425lm | 3000K

Options	Prod. no.
● black	1003436

HELIA AMBIENT 35 PD

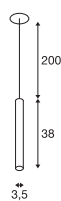
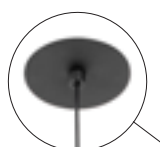

500mA
Total wattage: 7.5W
Material: aluminium/acrylic

- Open cable end
- Diameter built-in rosette 68 mm



Down 425lm | 3000K

Options	Prod. no.
● black	1003435



Product	Prod. no.
LED driver 20W 350mA/500mA PHASE	
○ white	1007227 ●
LED driver 25W 150-700mA DALI dimmable	
○ white	1007229 ●
LED driver 21W 500mA strain relief included	
○ white	1007226 ●

1003436 300

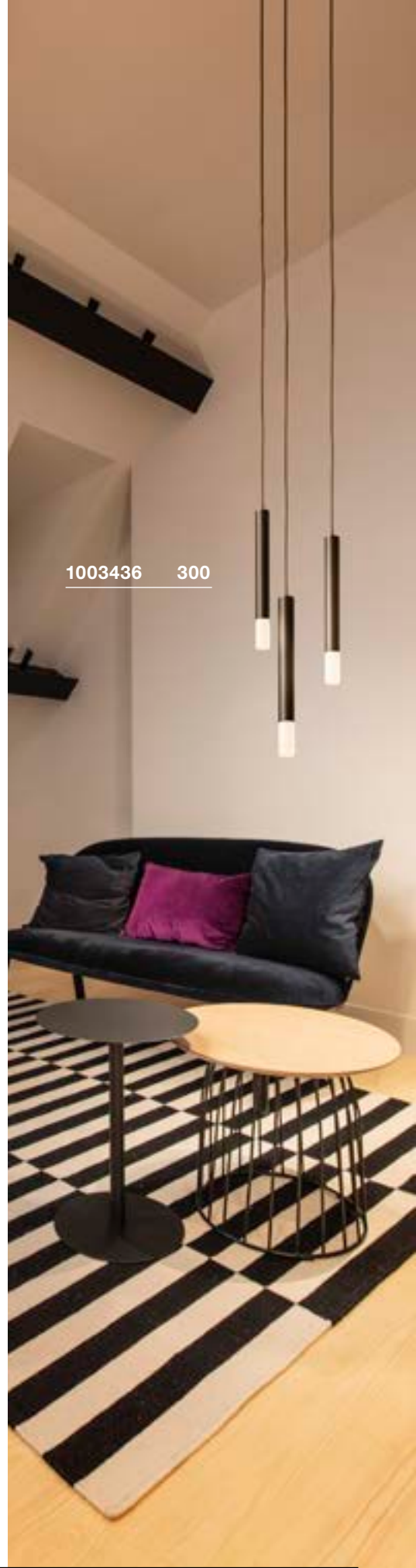

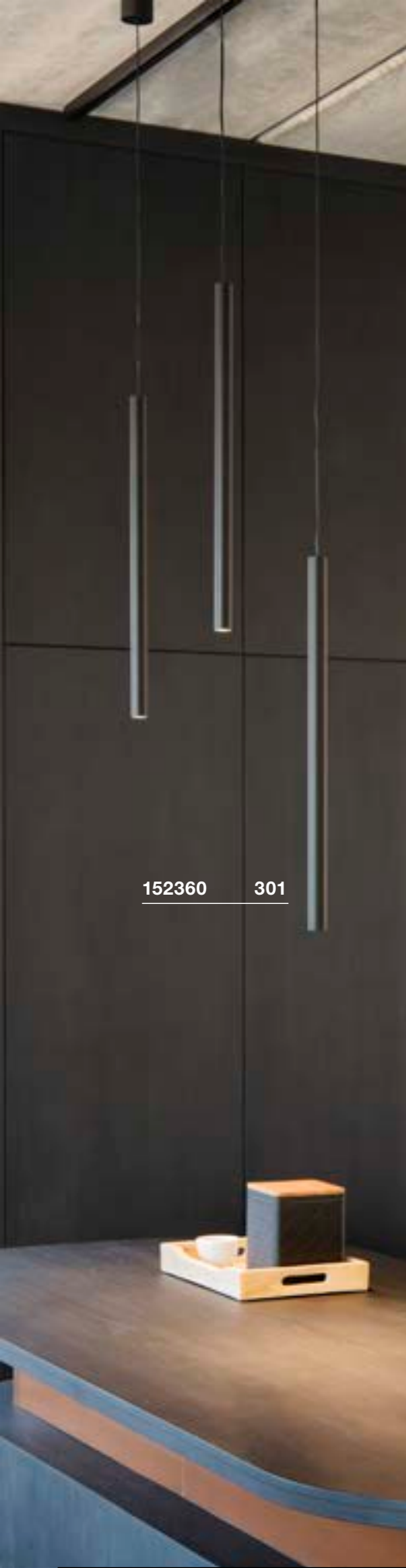

152360 301

HELIA 30 PD, PHASE

HELIA 30 PD

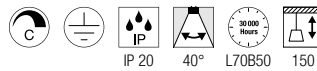
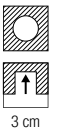
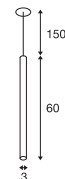
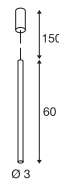

220-240V ~50/60Hz | 500mA
Total wattage: 9.2W
Material: aluminium

500mA
Total wattage: 7.5W
Material: aluminium

- Includes built-in rosette
- Material thickness of mounting surface: max. 12 mm
- Diameter built-in rosette 68 mm



Down 590lm | 3000K



Down 500lm | 3000K

Options	Prod. no.
● black	152360

Options	Prod. no.
● black	158400



Product	Prod. no.
LED driver 20W 350mA/500mA PHASE	
○ white	1007227 ●
LED driver 25W 150-700mA DALI dimmable	
○ white	1007229 ●
LED driver 21W 500mA strain relief included	
○ white	1007226 ●

152370 303





158400 303

HELIA 40 PD, PHASE

HELIA 40 PD

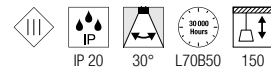
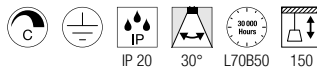
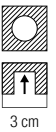
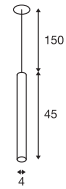

220-240V ~50/60Hz | 500mA
Total wattage: 10W
Material: aluminium

500mA
Total wattage: 9W
Material: aluminium

- Includes built-in rosette
- Material thickness of mounting surface: max. 12 mm
- Diameter built-in rosette 68 mm



Down 730lm | 3000K



Down 700lm | 3000K

Options	Prod. no.
● black	152370

Options	Prod. no.
● black	158410



Product	Prod. no.
LED driver 20W 350mA/500mA PHASE	
○ white	1007227 ●
LED driver 25W 150-700mA DALI dimmable	
○ white	1007229 ●
LED driver 21W 500mA strain relief included	
○ white	1007226 ●



149388 305



ASTINA PD, QPAR51

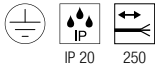
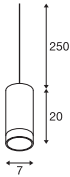

220-240V ~50/60Hz
Material: aluminium

- Open cable end



Base: 1xGU10

Options	Prod. no.
● black	1002939
○ white	1002937



LED GU10 51mm | 6W | 36°
2200-2700K | 360lm | EEK=G
6kWh/1000h



Prod. no.: 1005273



Product	Prod. no.
1-phase adapter	
● black	143120
○ white	143121
● grey	143124
3-phase light adapter	
● black	145990
● grey	145994
○ white	1001542
Fitu single ceiling rose, round	
● black	132600
● chrome	132605
Fitu single ceiling rose	
○ white	132601
Fitu set of 3 ceiling roses, round	
● black	132610
○ white	132611

ENOLA B PD, QPAR51

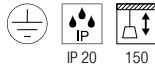
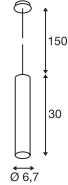

220-240V ~50/60Hz
Material: aluminium/steel



Base: 1xGU10

Options	Prod. no.
● black	151850
○ white	151851
● gold	151853



LED GU10 51mm | 6W | 38°
2700K | 450lm | EEK=F
6kWh/1000h



Prod. no.: 1005077

ENOLA PD, E27

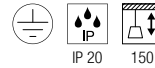
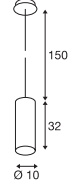
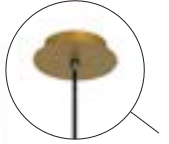

220-240V ~50/60Hz
Material: aluminium/steel



Base: 1xE27

Max. Ø: 9 cm

L: 18 cm

Options	Prod. no.
● black	149388
○ white	149381
● gold	149387



LED E27 | 13.2W | 220°
2700K | 1300lm | EEK=F
13kWh/1000h



Prod. no.: 1005302

ANELA
PD, PHASE

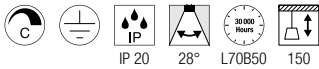

220-240V ~50/60Hz | 500mA
Total wattage: 10W
Material: aluminium

- Reflector not included
- Luminous flux with reflector 1000809 = 500lm/ luminous flux with reflector 1000810 = 620lm/ luminous flux with reflector 1000811 = 200lm/ luminous flux with reflector 1000812 = 600lm



Down 220lm | 3000K 750lm |

Options	Prod. no.
● black	1000813



Product	Prod. no.
Reflector 28°	
● black	1000811
○ white	1000812
● gold	1000809
● grey	1000810

LISENNE
PD, E27

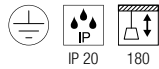

220-240V ~50/60Hz
Material: basalt/glass



Base: 1xE27 Max. Ø: 5.9 cm L: 15 cm

Options	Prod. no.
● grey/brown	155714



LED E27 | 8W | 240°
3000K | 880lm | EEK=E
8kWh/1000h

Prod. no.: 1005289

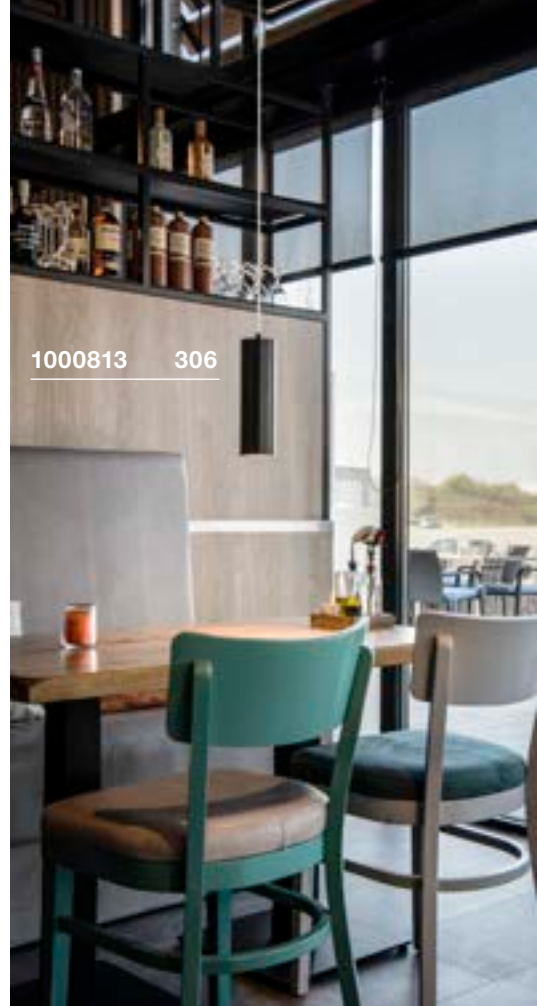



133444 307

TONGA®
PD, E14

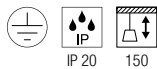
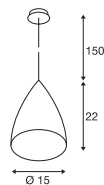

220-240V ~50/60Hz
Material: aluminium/glass



Base: 1xE14 Max. Ø: 5.1 cm L: 13 cm

Options	Prod. no.
● grey	133444

C35 | 4.2W | 320°
2700K | 350lm | EEK=G
5kWh/1000h

Prod. no.: 1005285



QUADRASS
PD, E27

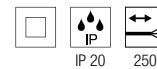
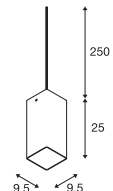

220-240V ~50/60Hz
Material: steel/glass



Base: 1xE27 Max. Ø: 6.5 cm L: 18 cm

Options	Prod. no.
● chrome	1003432

LED E27 | 13.2W | 220°
2700K | 1300lm | EEK=F
13kWh/1000h

Prod. no.: 1005302



Product	Prod. no.
1-phase adapter	
○ white	143121
3-phase light adapter	
○ white	1001542
Fitu single ceiling rose	
○ white	132601

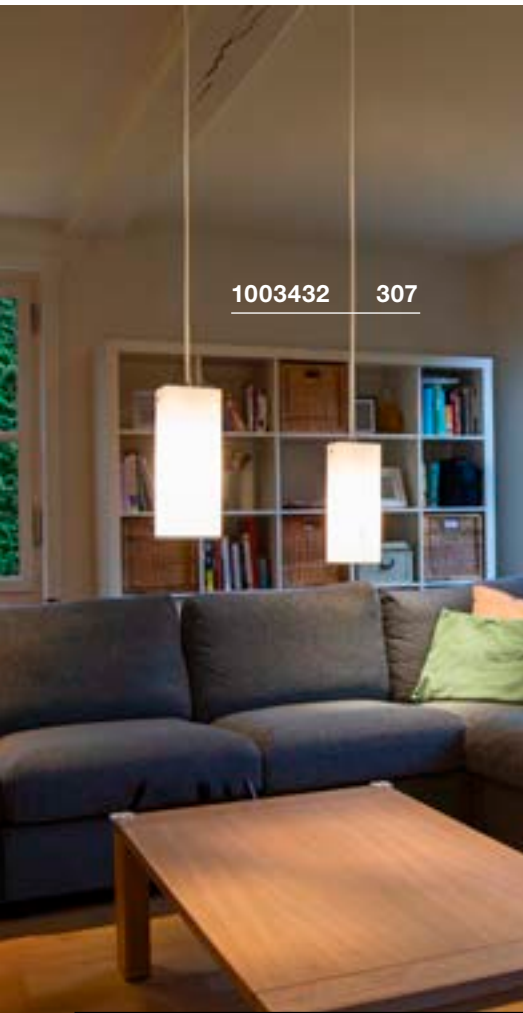

1003432 307



1006159 309



133019 309



133060 309



PARA CONE GL PD, GU10

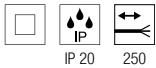
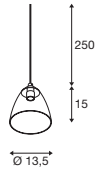

220-240V ~50/60Hz
Material: aluminium/glass

- Open cable end



Base: 1xGU10

Options	Prod. no.
● black	1006159
○ white	1006160



LED GU10 51mm | 6W | 38°
2700K | 450lm | EEK=F
6kWh/1000h



Prod. no.: 1005077



Product	Prod. no.
1-phase adapter	
● black	143120
○ white	143121
● grey	143124
3-phase light adapter	
● black	145990
● grey	145994
○ white	1001542
Surface-mounted ceiling rose	
● black	1004744
○ white	1004745
● chrome	1004746
Recessed ceiling rose	
● black	1004674
○ white	1004675
Fitu single ceiling rose, round	
● black	132600
● chrome	132605
Fitu single ceiling rose	
○ white	132601

PARA CONE 20 PD, E27

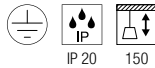
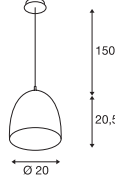

220-240V ~50/60Hz
Material: aluminium/steel

- Textile cable
- black/gold version with golden reflector
- all other versions with white reflector



Base: 1xE27

Options	Prod. no.
● gold/black	133050
● copper	133009



A60 | 7.5W | 320°
2700K | 800lm | EEK=F
8kWh/1000h



Prod. no.: 1005303

PARA CONE 30 PD, E27

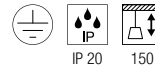
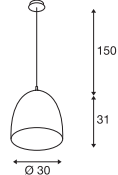

220-240V ~50/60Hz
Material: aluminium/steel

- Textile cable
- black/gold version with golden reflector
- all other versions with white reflector



Base: 1xE27

Options	Prod. no.
● black/gold	133060
● copper	133019



A60 | 7.5W | 320°
2700K | 800lm | EEK=F
8kWh/1000h



Prod. no.: 1005303



1002949 311

1002951 310

1002950 311



1002949 311

PHELIA 10 PD, E27

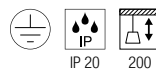
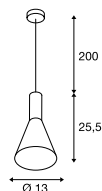

220-240V ~50/60Hz
Material: aluminium

- Textile cable

**SOCKET
INSIDE** <23
W

Base: 1xE27

Options	Prod. no.
● black/gold	1002951



A60 | 7.5W | 180°
2700K | 720lm | EEK=F
8kWh/1000h



Prod. no.: 1005305



PHELIA 20
PD, E27

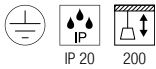
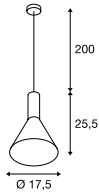

220-240V ~50/60Hz
Material: aluminium

- Textile cable



Base: 1xE27

Options	Prod. no.
● black/gold	1002948



LED E27 | 13.2W | 220°
2700K | 1300lm | EEK=F
13kWh/1000h



Prod. no.: 1005302

PHELIA 25
PD, E27

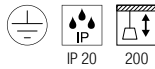
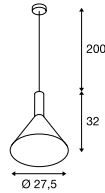

220-240V ~50/60Hz
Material: aluminium

- Textile cable



Base: 1xE27

Options	Prod. no.
● black/gold	1002949



LED E27 | 13.2W | 220°
2700K | 1300lm | EEK=F
13kWh/1000h



Prod. no.: 1005302

PHELIA 30
PD, E27

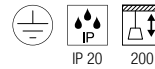
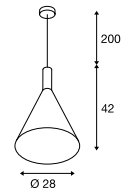

220-240V ~50/60Hz
Material: aluminium

- Textile cable



Base: 1xE27

Options	Prod. no.
● black/gold	1002950



G125 | 7.5W | 320°
2700K | 800lm
EEK=F 8kWh/1000h



Prod. no.: 1005310

FORCHINI 50
PD, E27

FORCHINI 70
PD, E27

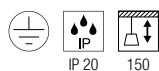
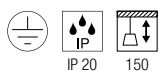
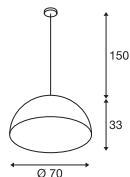
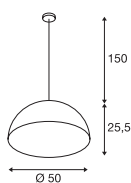

220-240V ~50/60Hz
Material: GFK

220-240V ~50/60Hz
Material: GFK

- Textile cable

- Textile cable



Base: 1xE27 max. L: 20 cm

Base: 1xE27 max. L: 20 cm

Options	Prod. no.
● black/gold	155530

Options	Prod. no.
● black/gold	1001701

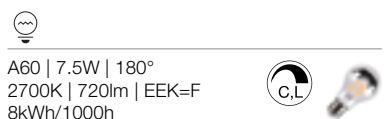

A60 | 7.5W | 180°
2700K | 720lm | EEK=F
8kWh/1000h

Prod. no.: 1005305

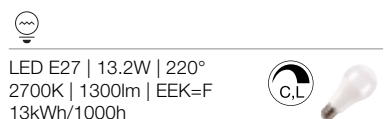

LED E27 | 13.2W | 220°
2700K | 1300lm | EEK=F
13kWh/1000h

Prod. no.: 1005302

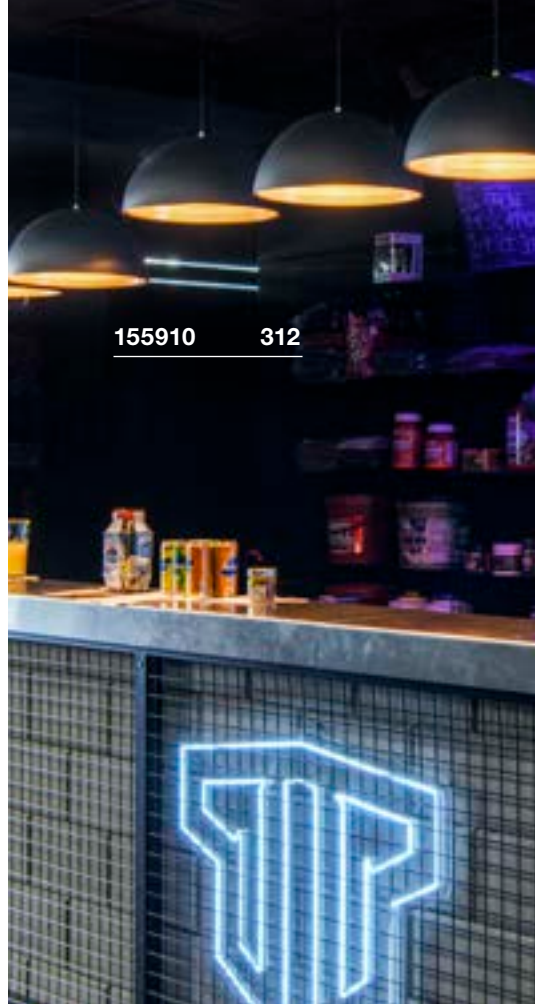

155910 312



1001701 311



FORCHINI M 40
PD, E27

FORCHINI M 50
PD, E27

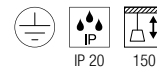
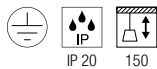
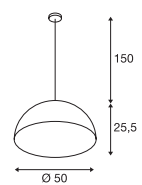
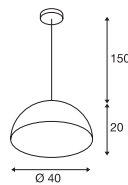

220-240V ~50/60Hz
Material: aluminium/steel

220-240V ~50/60Hz
Material: aluminium/steel

- Textile cable

- Textile cable



Base: 1xE27 max. L: 15,2 cm

Base: 1xE27 max. L: 18 cm

Options	Prod. no.
● black/gold	155910

Options	Prod. no.
● black/gold	155930



A60 | 7.5W | 180°
2700K | 720lm | EEK=F
8kWh/1000h



Prod. no.: 1005305



LED E27 | 13.2W | 220°
2700K | 1300lm | EEK=F
13kWh/1000h



Prod. no.: 1005302



LIGHT EYE® 90
PD, GU10

LIGHT EYE® 150
PD, QPAR111

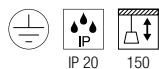
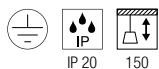
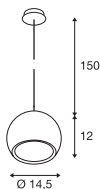
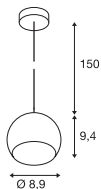

220-240V ~50/60Hz
Material: steel

220-240V ~50/60Hz
Material: steel

- Textile cable

- Textile cable



Base: 1xGU10

Base: 1xGU10

Options	Prod. no.
● black/chrome	133490

Options	Prod. no.
○ white/chrome	133481
● chrome	133482
● copper	133489

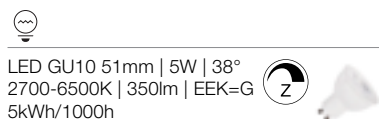

Prod. no.: 1005311

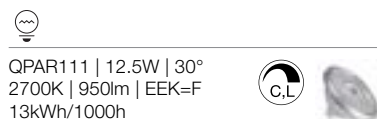

Prod. no.: 1005276

Product	Prod. no.
Lamp decorative ring diameter 5.7cm	
● black	151040
○ white	151041
● chrome	151049

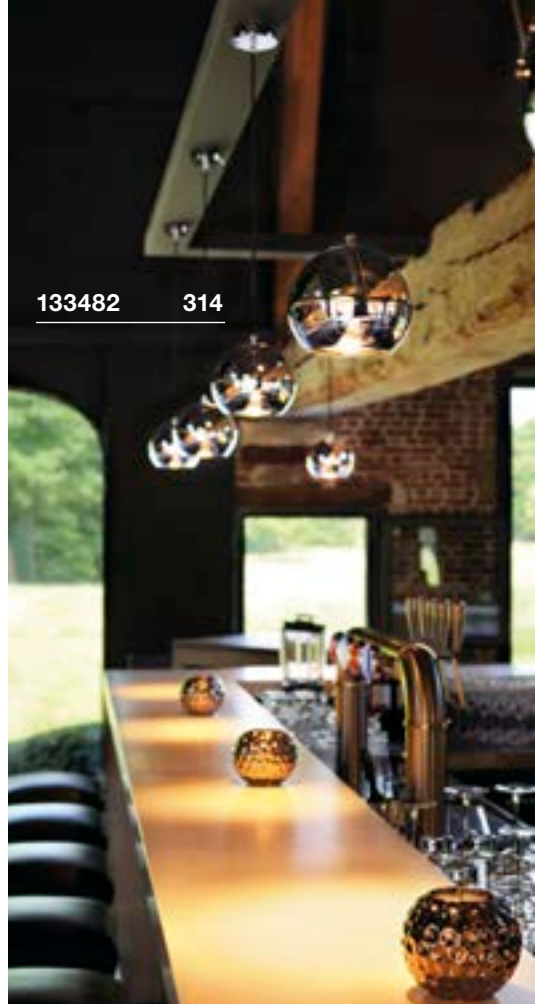

133482 314



133481 314

SUN / BIG SUN
PD, E27

1002045 315

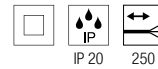
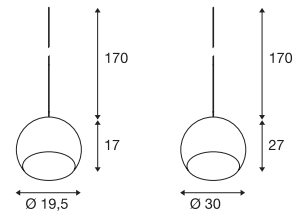
220-240V ~50/60Hz
Material: steel/glass

- Matching accessories can be found on page 295
- Open cable end

SOCKET
INSIDE <60
W

Base: 1xE27

Max. Ø: 7 cm

L: 12 cm

Options **Prod. no.**○ 1xE27 | Ø: 19.5 cm **1002045**○ 1xE27 | Ø: 30 cm **1002046**A60 | 7.5W | 320°
2700K | 800lm | EEK=F
8kWh/1000h**Prod. no.:** 1005303

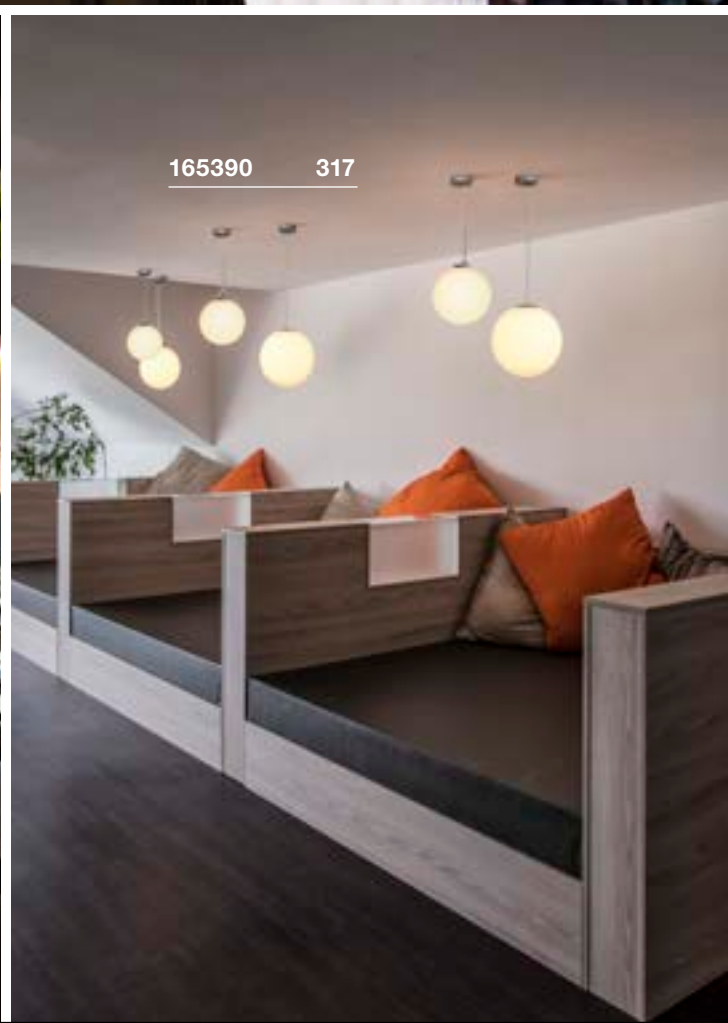



ROTOBALL 25 PD, E27

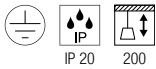

220-240V ~50/60Hz
Material: steel/polyethylene (PE)



Base: 1xE27 Max. Ø: 7 cm

Options	Prod. no.
<input type="radio"/> white	165390

LED E27 | 13.2W | 220°
 2700K | 1300lm | EEK=F
 13kWh/1000h

Prod. no.: 1005302

ROTOBALL 40 PD, E27

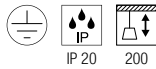

220-240V ~50/60Hz
Material: steel/polyethylene (PE)



Base: 1xE27 Max. Ø: 9.5 cm

Options	Prod. no.
<input type="radio"/> white	165410

LED E27 | 13.2W | 220°
 2700K | 1300lm | EEK=F
 13kWh/1000h

Prod. no.: 1005302

ROTOBALL 50 PD, E27

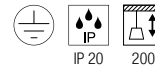

220-240V ~50/60Hz
Material: steel/polyethylene (PE)



Base: 1xE27 Max. Ø: 9.5 cm

Options	Prod. no.
<input type="radio"/> white	165400

LED E27 | 13.2W | 220°
 2700K | 1300lm | EEK=F
 13kWh/1000h

Prod. no.: 1005302

PARA DOME PD, E27

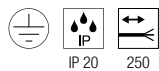
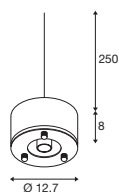

220-240V ~50/60Hz
Material: aluminium

- Open cable end



Base: 1xE27 Max. Ø: 7 cm

Options	Prod. no.
● black	1005214
● grey	1005215

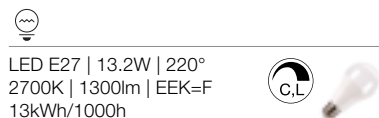

LED E27 | 13.2W | 220°
2700K | 1300lm | EEK=F
13kWh/1000h

Prod. no.: 1005302

Product	Prod. no.
1-phase adapter	
● black	143120
3-phase light adapter	
● black	145990
Surface-mounted ceiling rose	
● black	1004744
Ceiling rosette	
● black	210060
Fitu single ceiling rose, round	
● black	132600

PARA DOME Shade



H: 20.6 cm
Diameter: 30.8 cm
Material: aluminium

Options	Prod. no.
● black	1005216
● black/gold	1006410
● grey	1005217

PARA DOME Shade



H: 20 cm
Diameter: 31.5 cm
Material: polycarbonate (PC)

Options	Prod. no.
○ transparent	1005218



165358 319



165359 319



PARA 380

PD, E27

165359

319

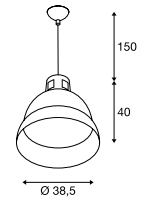

IP 20 150

220-240V ~50/60Hz
Material: aluminium

SOCKET **INSIDE** <20
W

Base: 1xE27

Options	Prod. no.
● black	165359
● aluminium	165358



LED E27 | 13.2W | 220°
2700K | 1300lm | EEC=F
13kWh/1000h



Prod. no.: 1005302

1007612 325





LED
LYGANT | 325



LED
LYGANT | 325



SOCKET
VARYT | 327



LED
SEDO 7 | 329



LED
SEDO 14 | 329



LED
SEDO 21 | 329



LED
TRUKKO | 330



LED
TRUKKO | 330



LED
TRUKKO | 331



LED
TRUKKO 80 | 331



LED
TRUKKO 60 | 332



LED
TRUKKO 90 | 332



LED
MARYLIN 40 | 333



LED
WL 149 | 334



SOCKET
WL 149 | 334



SOCKET
WL 106 | 335



SOCKET
WL 106 | 335



SOCKET
MIBO UP/DOWN | 337



LED
MAGANDA | 337



LED
DORISA 30 | 339



LED
DORISA 50 | 339



LED
GLENOS® 60 | 339



LED
L-LINE 60 | 341



LED
L-LINE 120 | 341



LED
Q-LINE® | 341

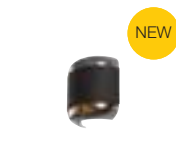

SOCKET
PANTILO ROPE | 345



SOCKET
ASTO TUBE | 347



SOCKET
ASTO TUBE | 347



LED
MANA BASE | 349



MANA BASE | 349



MANA 40 | 319



MANA 60 | 349



LED
MANA | 351



MANA | 351



MANA | 351



LED
MANA | 353



LED
MANA | 353



MANA | 353



MANA | 353



LED
OCULUS | 355



LED
OCULUS
UP/DOWN | 355



SOCKET
PLASTRA | 356



SCKET
PLASTRA | 356



SCKET
PLASTRA | 357



SCKET
PLASTRA | 357



SCKET
PLASTRA | 359



LED
PLASTRA | 359



LED
PLASTRA | 359



SCKET
PLASTRA | 360



SCKET
PLASTRA 101 | 361



SCKET
PLASTRA | 361



SCKET
PLASTRA 104 | 361



LED
LOGS IN | 362



LED
LOGS IN | 362



LED
LOGS IN L | 363



LED
LOGS IN L | 363



LED
QUAD FRAME 14 | 364



LED
QUAD FRAME 19 | 364



LED
SHELL 15 | 365



LED
SHELL 30 | 365



LED
ASSO 300 | 366



LED
ASSO 300 | 367



SCKET
OSSA 180 | 367



SCKET
OSSA 300 | 367



LED
CARISO | 368



LED
CARISO | 368



LED
CHROMBO | 369



LED
DIRETO 60 | 370



LED
DIRETO 90 | 370



LED
ARLINA 60 | 371



LED
ARLINA 130 | 371



SCKET
ANDREAS | 373



SCKET
DENA 30 | 373



SCKET
BASKET | 373



SCKET
QUADRASS | 375



LED
QUADRASS
SPOT | 375



SCKET
LISENNE | 375



SCKET
FITU | 376



SCKET
FITU CUBE | 376



SCKET
THEO UP/DOWN | 377



SCKET
SOLID CUBE | 377



ENOLA B | 379



ENOLA B | 379



**ASTINA
UP/DOWN** | 379



SCKET

FENDA | 380



FENDA | 380



LED

KENKUA SPOT | 381



LED

COUPA FLEX | 381



LED

KARPO MAGN | 382



LED

KARPO GOOSE | 382



LED

KARPO 30 | 383



LED

KARPO | 383



LED

SOMNILA SPOT | 384



LED

SOMNILA SPOT | 385



LED

SOMNILA FLEX | 385



LED

SOMNILA FLEX | 385



SCKET

DIO FLEX PLATE | 387



LED

DIO FLEX PLATE | 387



LED

DIO FLEX PLATE | 387



SCKET

PHELIA | 388



LED

MERADO FLOOD | 388



SCKET

DISPLAY ADL 50 | 389

1007619 325





LYGANT WL, single

LYGANT WL, double

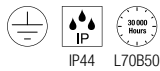
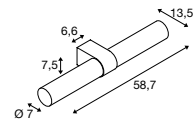
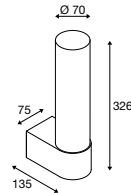

IP44 L70B50

220-240V ~50/60Hz | 700mA
Total wattage: 8W
Material: stainless steel/glass

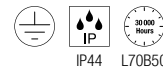

IP44 L70B50

220-240V ~50/60Hz | 500mA
Total wattage: 11W
Material: stainless steel/glass



Down 560lm | 3000K



Down 800lm | 3000K

Options	Prod. no.
● black	1007614
○ white	1007613
● brass	1007612
● chrome	1007615

Options	Prod. no.
● black	1007618
○ white	1007617
● brass	1007616
● chrome	1007619

1007603 327



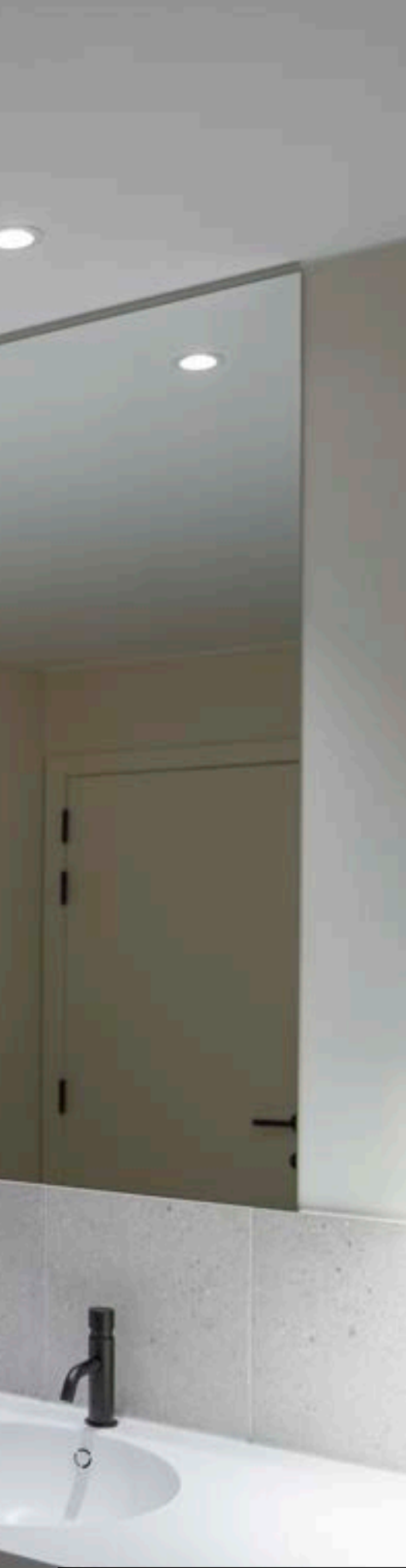

VARYT WL, E14

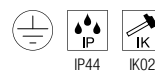
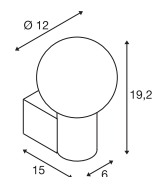

220-240V ~50/60Hz
Material: stainless steel/glass 1007601
Steel/glass 1007603, 1007602, 1007600

SOCKET
INSIDE <6
W

Base: 1xE14 Max. Ø: 3.8 cm L: 11 cm

Options	Prod. no.
● black	1007603 ●
○ white	1007602 ●
● brass	1007601 ●
● chrome	1007600 ●



C35 | 4.2W | 320°
2700K | 350lm | EEK=G
5kWh/1000h



Prod. no.: 1005285



151796 329



1002964 329



SEDO 7
WL

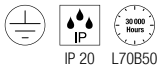
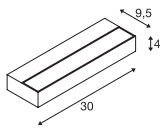

220-240V ~50/60Hz | 350mA
Total wattage: 11.5W
Material: aluminium/glass



Down 1020lm | 3000K

Options	Prod. no.
<input type="radio"/> white	1002962
<input checked="" type="radio"/> aluminium	1002964

SEDO 14
WL

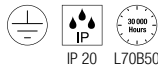
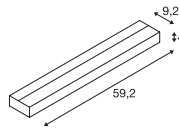

220-240V ~50/60Hz | 500mA
Total wattage: 18W
Material: aluminium/glass



Down 1300lm | 3000K

Options	Prod. no.
<input type="radio"/> white	151781
<input checked="" type="radio"/> aluminium	151786

SEDO 21
WL

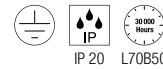
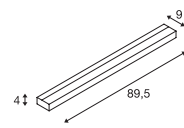

220-240V ~50/60Hz | 700mA
Total wattage: 30W
Material: aluminium/glass



Down 2500lm | 3000K

Options	Prod. no.
<input type="radio"/> white	151791
<input checked="" type="radio"/> aluminium	151796



1004729 330

TRUKKO
WL, square, mirror heating

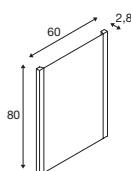
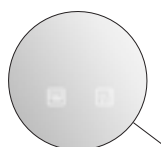

TRUKKO
WL, rectangular

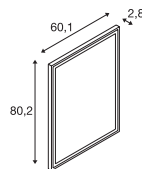
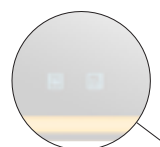

1004730 330



220-240V ~50/60Hz | 24V
Total wattage: 24 W
Material: glass/aluminium

- incl. mirror heating
- Light colour can be adjusted via touch function



1310lm | 3000K | 1320lm | 4000K | 1340lm | 6500K

Options **Prod. no.**
○ silver/opaque **1004729**



220-240V ~50/60Hz | 24V
Total wattage: 25W
Material: glass/plastic

- incl. mirror heating
- Light colour can be adjusted via touch function



1080lm | 3000K | 1290lm | 4000K | 1250lm | 6500K

Options **Prod. no.**
○ silver/opaque **1004730**



1007201 331



TRUKKO
WL, round

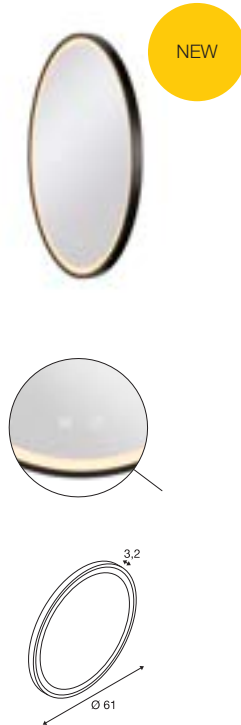

TRUKKO 80
WL, round



220-240V ~50/60Hz | 24V
Total wattage: 25W
Material: glass/ABS

- incl. mirror heating
- Light colour can be adjusted via touch function



730lm | 3000K | 710lm | 4000K | 720lm | 6500K

Options	Prod. no.
○ silver/opaque 1270/1260/1260lm	1004731
● transparent/black 730/710/720lm	1007201 ●

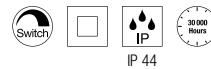

220-240V ~50/60Hz | 24V
Total wattage: 23W
Material: glass/ABS

- incl. mirror heating
- Light colour can be adjusted via touch function



730lm | 3000K | 740lm | 4000K | 790lm | 6500K

Options	Prod. no.
○ silver/opaque 1100/1130/1210lm	1007200 ●
● transparent/black 730/740/790lm	1007202 ●

1007202 331



TRUKKO 60
WL

TRUKKO 90
WL

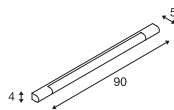
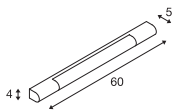

220-240V ~50/60Hz | 500mA
Total wattage: 9.2W
Material: aluminium/plastic

220-240V ~50/60Hz | 500mA
Total wattage: 12W
Material: aluminium/plastic



Down 750lm | 3000K

Down 1040lm | 3000K

Options	Prod. no.
● chrome	149762

Options	Prod. no.
● chrome	149772

149772 332



149772 332

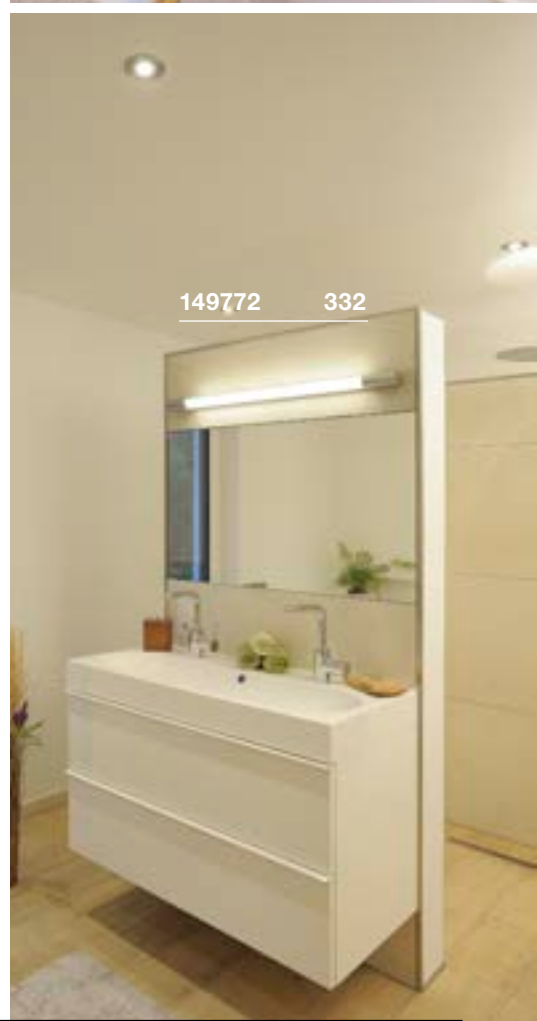



MARYLIN 40/60/90 WL

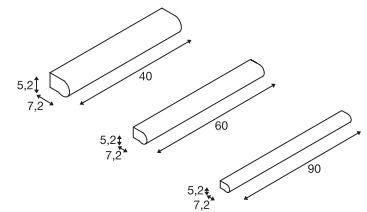

IP 44

120°

L70B50

220-240V ~50/60Hz | 350mA
Total wattage: 9.8W
Material: aluminium/polycarbonate (PC)



Down 890lm | 3000K | 980lm | 4000K

Options	Prod. no.
● chrome L: 40cm 890/980lm 9.8W	1002190
● chrome L: 60cm 1170/1280lm 16W	1002191
● chrome L: 90cm 1800/1990lm 21W	1002192

1002191 333

WL 149
WL, PHASE

WL 149
WL, QT-DE12

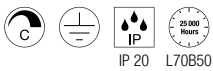
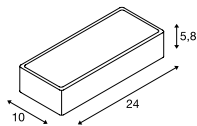
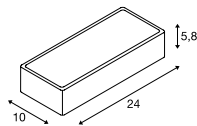

220-240V ~50/60Hz | 350mA
Total wattage: 14W
Material: steel/glass

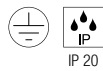

220-240V ~50/60Hz
Material: steel/glass



Down 1050lm | 3000K



Base: R7s 78mm

Options	Prod. no.
<input type="radio"/> white	149511

Options	Prod. no.
<input type="radio"/> white/frosted	149471



LED R7s | 9W | 330°
3000K | 1050lm | EEK=E
9kWh/1000h



Prod. no.: 1005287

149511 334

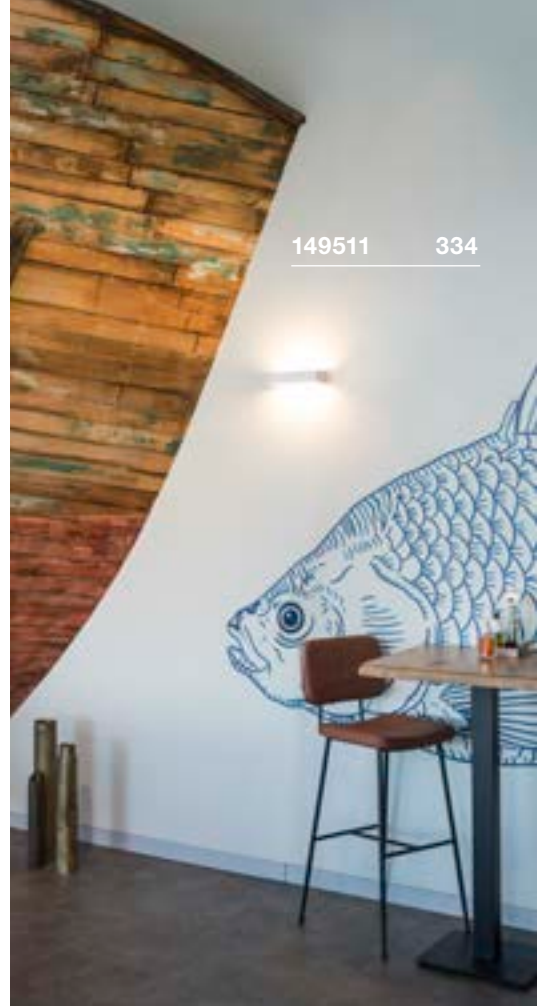

149471 334





1002228 335

WL 106
E14

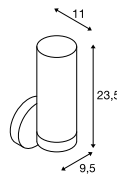

220-240V ~50/60Hz
Material: aluminium/glass



Base: 1xE14 Max. Ø: 3.6 cm L: 11 cm

Options	Prod. no.
● chrome	1002228

 C35 | 4.2W | 320°
2700K | 350lm | EEK=G
5kWh/1000h

Prod. no.: 1005285



WL 106
E14

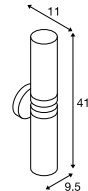

220-240V ~50/60Hz
Material: aluminium/glass



Base: 2xE14 Max. Ø: 3.6 cm L: 11 cm

Options	Prod. no.
● chrome	1002229

 C35 | 4.2W | 320°
2700K | 350lm | EEK=G
5kWh/1000h

Prod. no.: 1005285



1004971 337





MIBO UP/DOWN
WL, QT14

MAGANDA
WL

151282 337

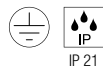
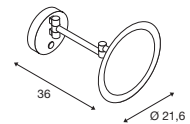
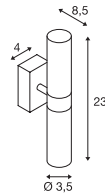

IP 21

220-240V ~50/60Hz
Material: aluminium/glass

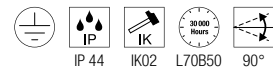

IP 44

IK02

L70B50

90°

100-240V ~50/60Hz | 12V
Total wattage: 4.8W
Material: steel/glass

- Light colour can be adjusted via the housing switch



Base: 2xG69



45.4lm | 2700K | 48lm | 3000K | 51lm | 4000K

Options	Prod. no.
● chrome	151282

Options	Prod. no.
● chrome	1004971



LED G9 | 3.6W | 300°
3000K | 400lm | EEK=E
4kWh/1000h

Prod. no.: 1005286



1003507 339





DORISA 30
WL

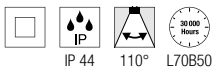
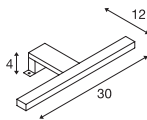

200-240V ~50Hz | 340mA
Total wattage: 5.2W
Material: aluminium/plastic

- Clamping range: 0-6mm
- Can be converted to a mirror light by removing the bracket



Down 300lm | 4000K

Options	Prod. no.
● chrome	1000777

DORISA 50
WL

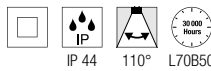
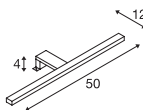

200-240V ~50Hz | 340mA
Total wattage: 6.6W
Material: aluminium/plastic

- Clamping range: 0-6mm
- Can be converted to a mirror light by removing the bracket



Down 370lm | 4000K

Options	Prod. no.
● chrome	1000780

GLENOS® 60
WL

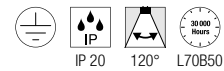
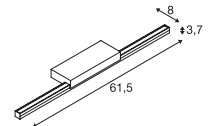

220-240V ~50/60Hz | 500mA
Total wattage: 12W
Material: aluminium/polycarbonate (PC)

- Clamping range: 0-6mm
- Can be converted to a mirror light by removing the bracket



Down 1170lm | 3000K
4000K

Options	Prod. no.
● black	1003506
○ white	1003507
● grey	1003508

1000669 341





L-LINE 60
WL

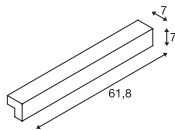

220-240V ~50/60Hz | 350mA
Total wattage: 10W
Material: aluminium/polycarbonate (PC)



Down 820lm | 3000K

Options	Prod. no.
<input type="radio"/> white	1001299
<input type="radio"/> silver	1001300

L-LINE 120
WL

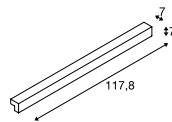

220-240V ~50/60Hz | 350mA
Total wattage: 18.5W
Material: aluminium/polycarbonate (PC)



Down 1650lm | 3000K

Options	Prod. no.
<input type="radio"/> white	1001303
<input type="radio"/> silver	1001304

Q-LINE®
WL

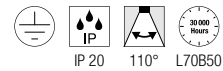
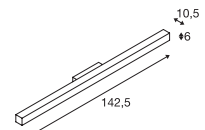

220-240V ~50/60Hz | 700mA
Total wattage: 45W
Material: aluminium/acrylic



Down 3800lm | 3000K

Options	Prod. no.
<input checked="" type="radio"/> black	1000669
<input type="radio"/> white	1000668
<input type="radio"/> grey	1000670

IP CLASSES

Play it safe with your lighting. No problem with SLV interior lights and the right IP rating for the relevant application area.

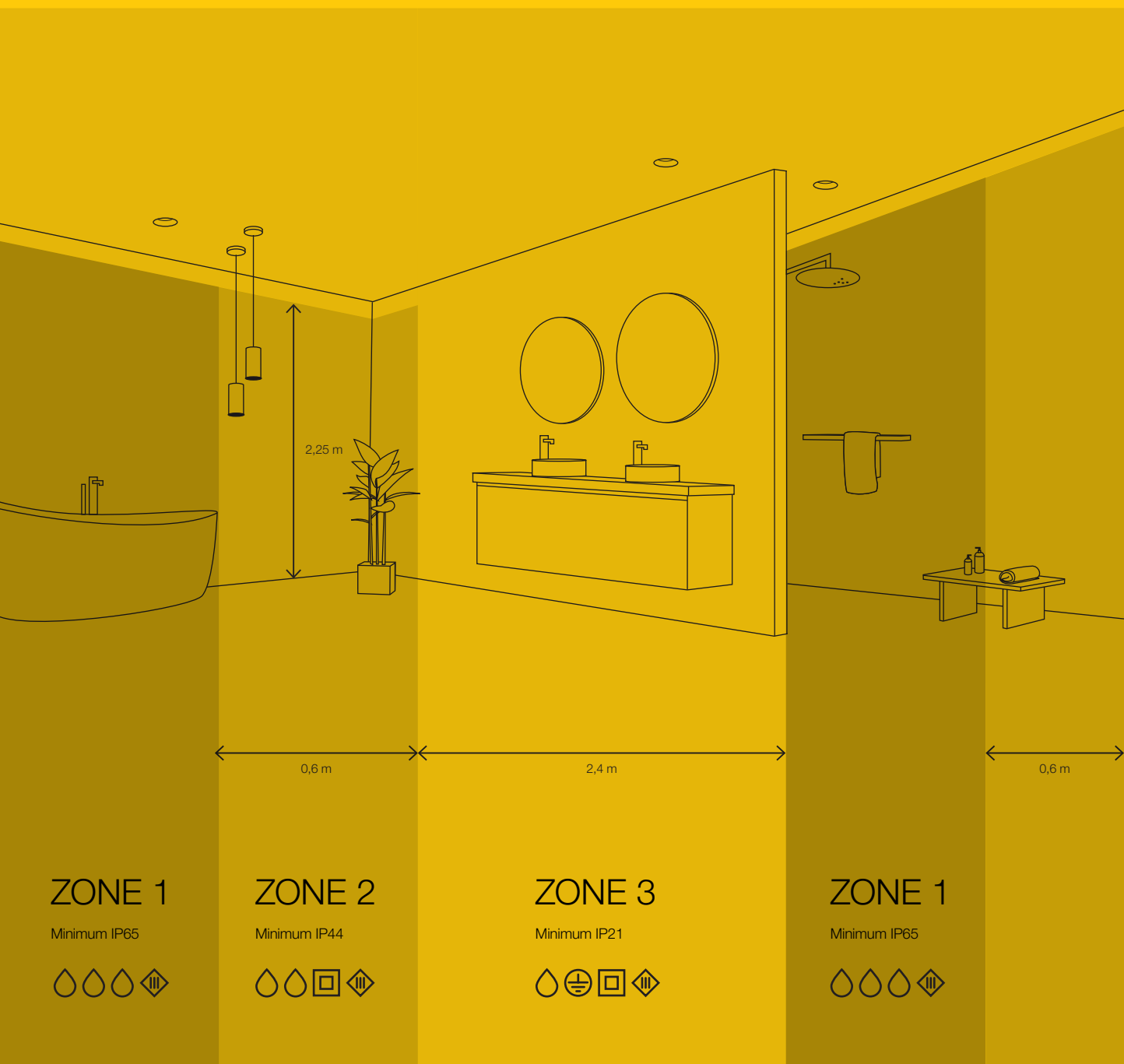

Lighting in a modern feel-good environment should be functional, restorative and safe, so it is vital to choose the right IP rating depending on where the light will be used.

The abbreviation IP stands for Ingress Protection. The first digit in these standardised IP codes indicates the protection against solid objects, the second digit indicates protection against moisture. It is the latter that is particularly important for bathrooms and outdoor areas.

FOREIGN OBJECTS WATER

No protection	0	0	No protection
protects against access with the back of a hand (diameter > 50 mm)	1	1	protection against vertically falling water droplets
protects against access with a finger (diameter > 12.5 mm)	2	2	protection against falling water droplets if the enclosure is tilted up to 15°
protects against access with a tool (diameter > 2.5 mm)	3	3	protection against spraying water falling at up to 60° from the vertical
protects against access with a wire (diameter > 1 mm)	4	4	protection against water splashing from all sides
Complete protection against contact (against harmful quantity of dust)	5	5	protection against water jets (from a nozzle) from any angle
complete protection against contact (dust-proof)	6	6	protection against powerful water jets
		7	protection against temporary immersion
		8	protection against continuous immersion

EXAMPLE IP 65:

The product has maximum dust protection at level 6 and high protection against water jets at level 5. It can therefore be classified as dust-tight and water-resistant.





PANTILO ROPE WL, G9

1007595 345



NEW

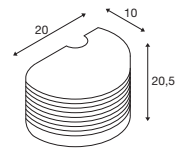

IP20

200-240V ~50/60Hz
Material: steel

SOCKET
INSIDE <15
W

Base: 1xG69

Max. Ø: 3 cm

L: 6 cm

Options	Prod. no.
● gold	1007595 ●
● silver	1007594 ●



LED G9 | 3.6W | 300°
3000K | 400lm | EEK=E
4kWh/1000h

Prod. no.: 1005286





1006441 347



1006444 347



ASTO TUBE
WL, single, GU10



ASTO TUBE
WL, up/down, GU10



ASTO TUBE
Decorative reflector



H: 3.95 cm
Diameter: 6.75 cm
Material: polycarbonate (PC)

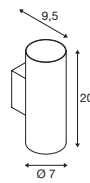
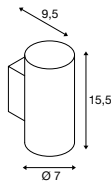

Options	Prod. no.
● black/chrome	1007190 ●
● gold	1006450 ●
● chrome	1006449 ●
● copper	1006451 ●

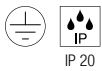

220-240V ~50/60Hz
Material: aluminium



Base: 1xGU10

Options	Prod. no.
● black	1006441 ●
○ white	1006442 ●

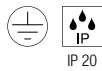

220-240V ~50/60Hz
Material: aluminium



Base: 2xGU10

Options	Prod. no.
● black	1006443 ●
○ white	1006444 ●



1004969 + 1004660 349

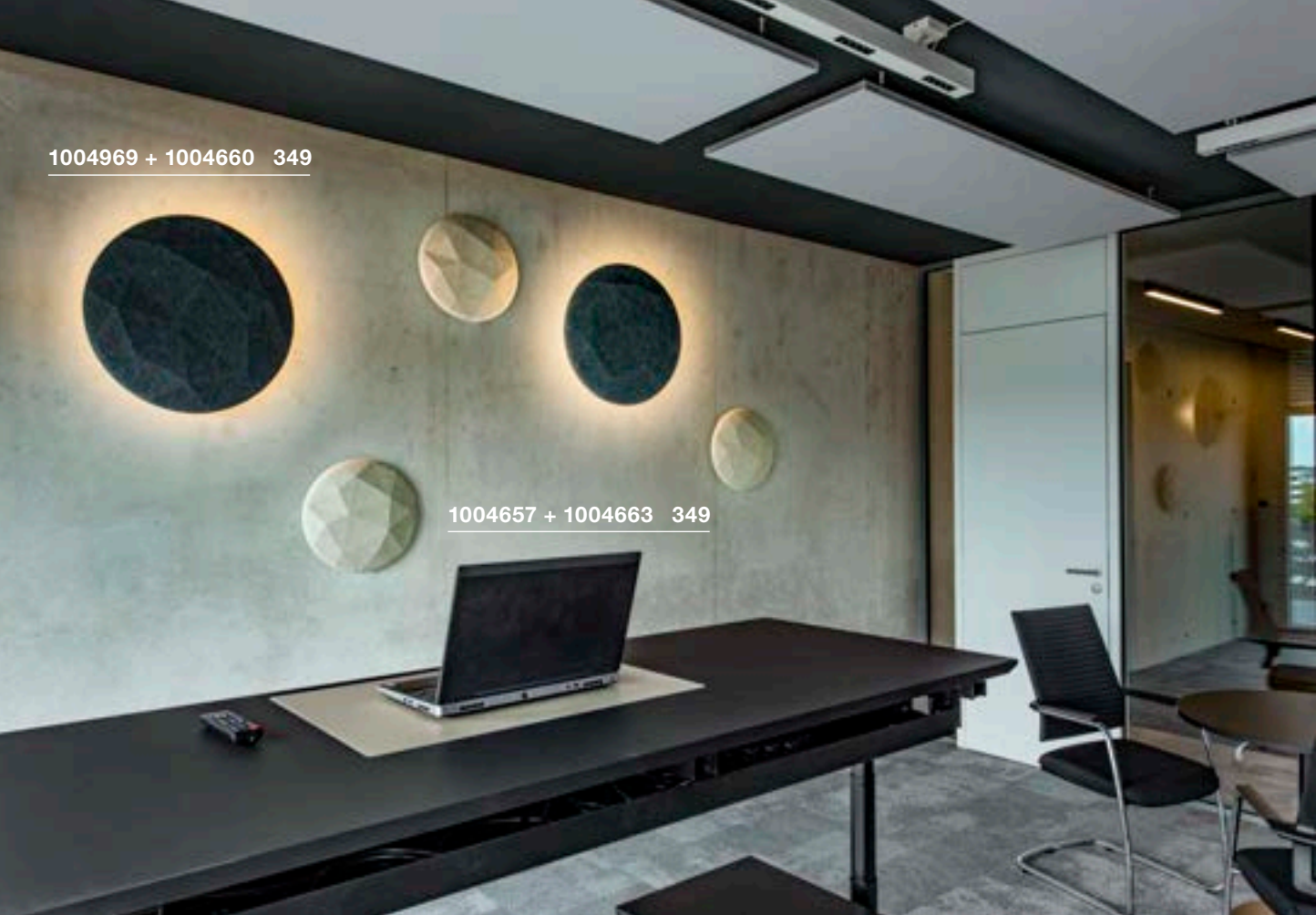

1004657 + 1004663 349

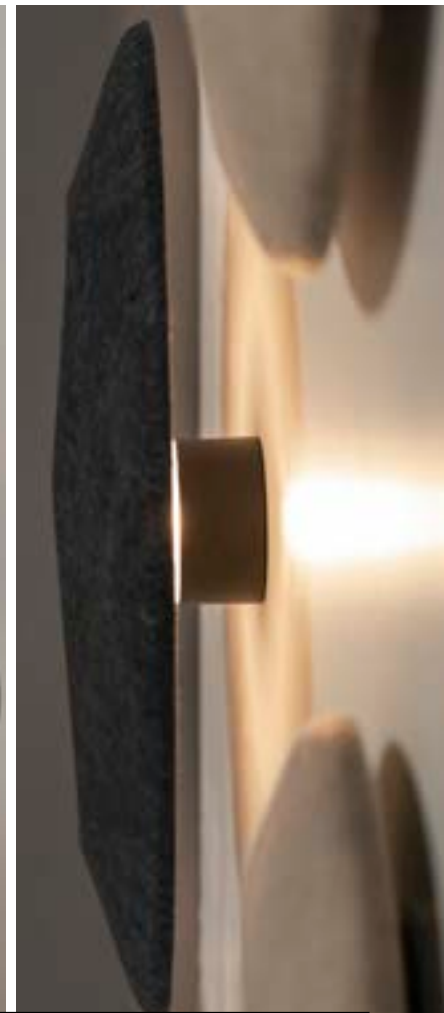
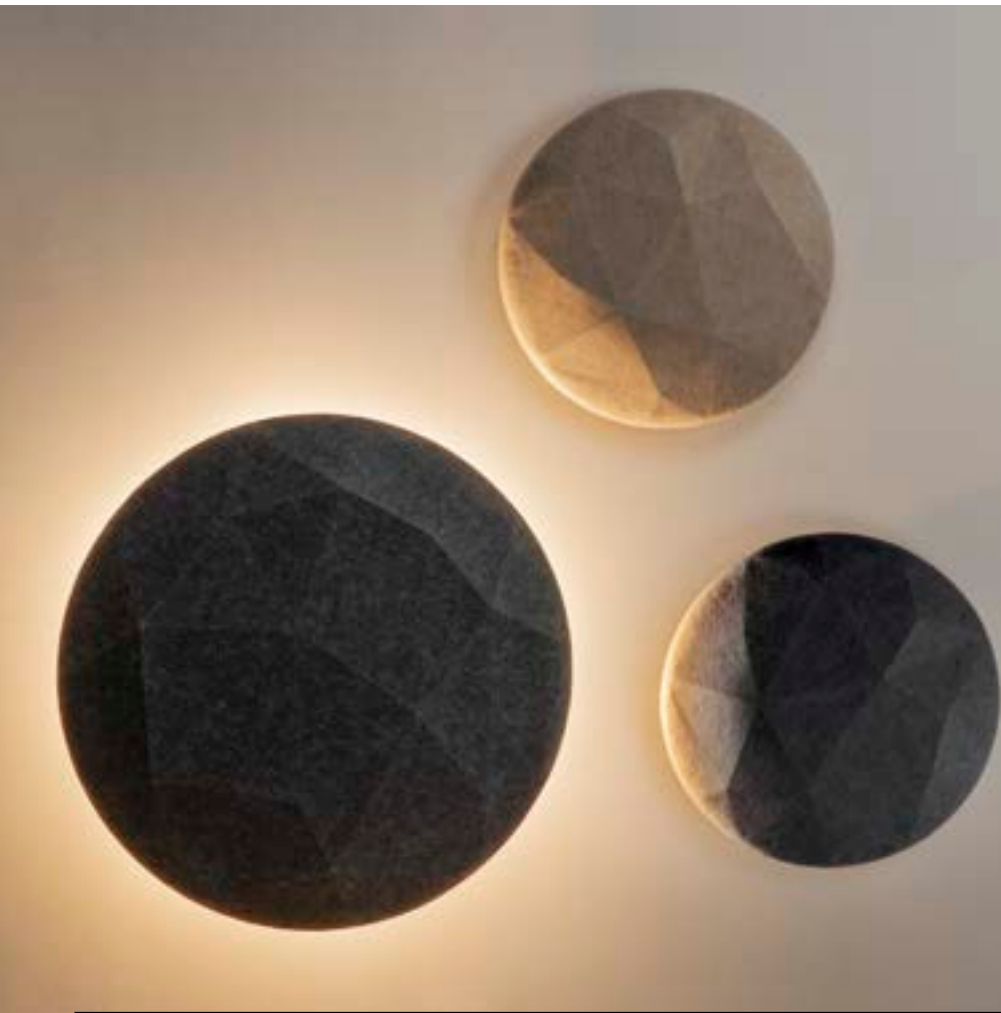



MANA BASE WL, round, PHASE

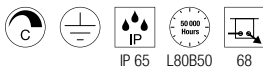
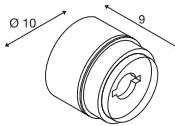

220-240V ~50/60Hz | 350mA
Total wattage: 15W
Material: aluminium/polycarbonate (PC)



Down 800lm | 2700K | 820lm | 3000K

Options	Prod. no.
● anthracite	1006319

MANA BASE round

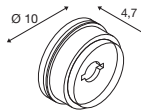

Material: aluminium/polycarbonate (PC)

- Non-illuminated base for round shades in the MANA series

Options	Prod. no.
● anthracite	1004969

MANA 40 shade, round



H: 6 cm
Diameter: 40 cm
Material: felt/aluminium

- The felt shade can be sound-absorbing if multiple shades are mounted on a wall

Options	Prod. no.
● grey	1004661
● beige	1004660

MANA 60 shade, round



H: 6 cm
Diameter: 60 cm
Material: felt/aluminium

- The felt shade can be sound-absorbing if multiple shades are mounted on a wall

Options	Prod. no.
● grey	1004663
● beige	1004662

1000613 + 1000824 351





MANA WL, Base, PHASE

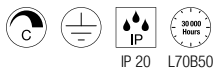
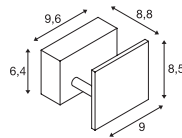

220-240V ~50/60Hz | 350mA
 Total wattage: 8.3W
 Material: aluminium/steel



Down 520lm | 2000-3000K

Options	Prod. no.
<input type="radio"/> white	1000613

MANA Shade



L: 12 cm H: 10 cm D: 9 cm
 Material: wood

- suitable only with 1000613

Options	Prod. no.
<input type="radio"/> white	1000618
<input checked="" type="radio"/> grey/brown	1000616

MANA Shade



W: 13.6 cm H: 10 cm D: 9.5 cm
 Material: plaster/steel

- suitable only with 1000613
- Can be painted over/wallpapered to match wall colour

Options	Prod. no.
<input type="radio"/> white	1000824

1000615 + 1000823 353





MANA WL, Base, PHASE

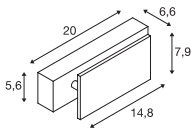

220-240V ~50/60Hz | 350mA
Total wattage: 15W
Material: aluminium/steel



Down 700lm | 2000-3000K

Options	Prod. no.
<input type="radio"/> white	1000614

MANA WL, Base

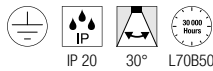
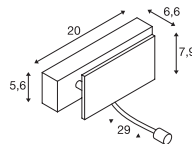

220-240V ~50/60Hz | 350/500mA
Total wattage: 11W
Material: aluminium/steel



Down 650lm | 3000K

Options	Prod. no.
<input type="radio"/> white/chrome	1000615

- Spotlights with separate switches

MANA Shade



L: 29 cm H: 9.5 cm D: 7 cm
Material: wood

- suitable only with 1000614/1000615

Options	Prod. no.
<input type="radio"/> white	1000623
<input type="radio"/> grey/brown	1000621

MANA Shade

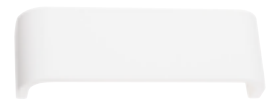

W: 30.9 cm H: 9.5 cm D: 7.4 cm
Material: plaster/steel

- suitable only with 1000614/1000615
- Can be painted over/wallpapered to match wall colour

Options	Prod. no.
<input type="radio"/> white	1000825

1006308 355





OCULUS WL, single, PHASE



OCULUS UP/DOWN WL, PHASE



1004671 355

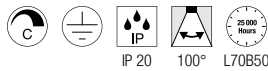
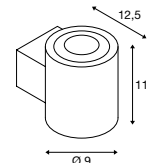
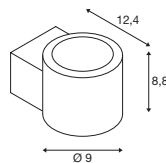

220-240V ~50/60Hz | 350mA
Total wattage: 8.5W
Material: aluminium/glass

220-240V ~50/60Hz | 700mA
Total wattage: 15W
Material: aluminium/glass

• Additional frosted lens included



Down 570lm | 2000-3000K



Up Down 22lm | 2000K - 555lm | 3000K

Options	Prod. no.
● black	1006307
○ white	1006308

Options	Prod. no.
● black	1004670
○ white	1004671

PLASTRA
WL, Cube, QT14

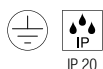
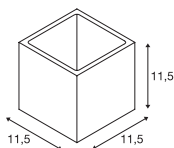

220-240V ~50/60Hz
Material: plaster/steel

- Can be painted over/wallpapered to match wall colour

SOCKET INSIDE <42
W

Base: 1xG69

Options	Prod. no.
<input type="radio"/> white	148018



LED G9 | 3.6W | 300°
3000K | 400lm | EEK=E
4kWh/1000h

Prod. no.: 1005286



PLASTRA
WL, Cubes

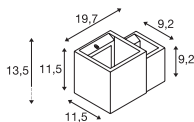
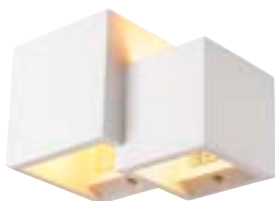

220-240V ~50/60Hz
Material: plaster/steel

- Can be painted over/wallpapered to match wall colour

SOCKET INSIDE 15
W

Base: 2xG69

Max. Ø: 7 cm | L: 4 cm

Options	Prod. no.
<input type="radio"/> white	1004733



LED G9 | 3.6W | 300°
3000K | 400lm | EEK=E
4kWh/1000h

Prod. no.: 1005286



148018 356

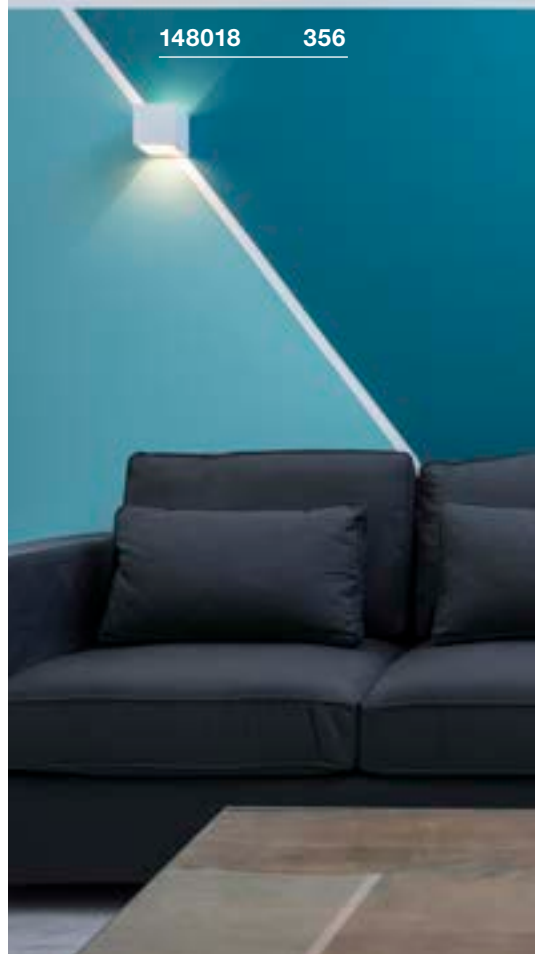

1002238 357





PLASTRA
WL, rectangular, QT-DE12

PLASTRA
WL, E14

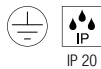
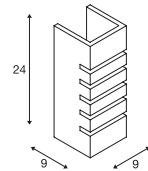
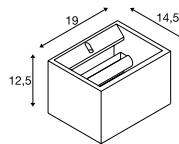

220-240V ~50/60Hz
Material: plaster/steel

220-240V ~50/60Hz
Material: plaster/steel

- Can be painted over/wallpapered to match wall colour

- Can be painted over/wallpapered to match wall colour



Base: 1xR7s 118mm

Base: 1xE14

Options	Prod. no.
<input type="radio"/> white	1002238

Options	Prod. no.
<input type="radio"/> white	148010



LED R7s | 15W | 330°
3000K | 2000lm | EEK=E
15kWh/1000h



Prod. no.: 1005288



C35 | 4.2W | 320°
2700K | 350lm | EEK=G
5kWh/1000h



Prod. no.: 1005285



148010 357

1004732 359



148091 359

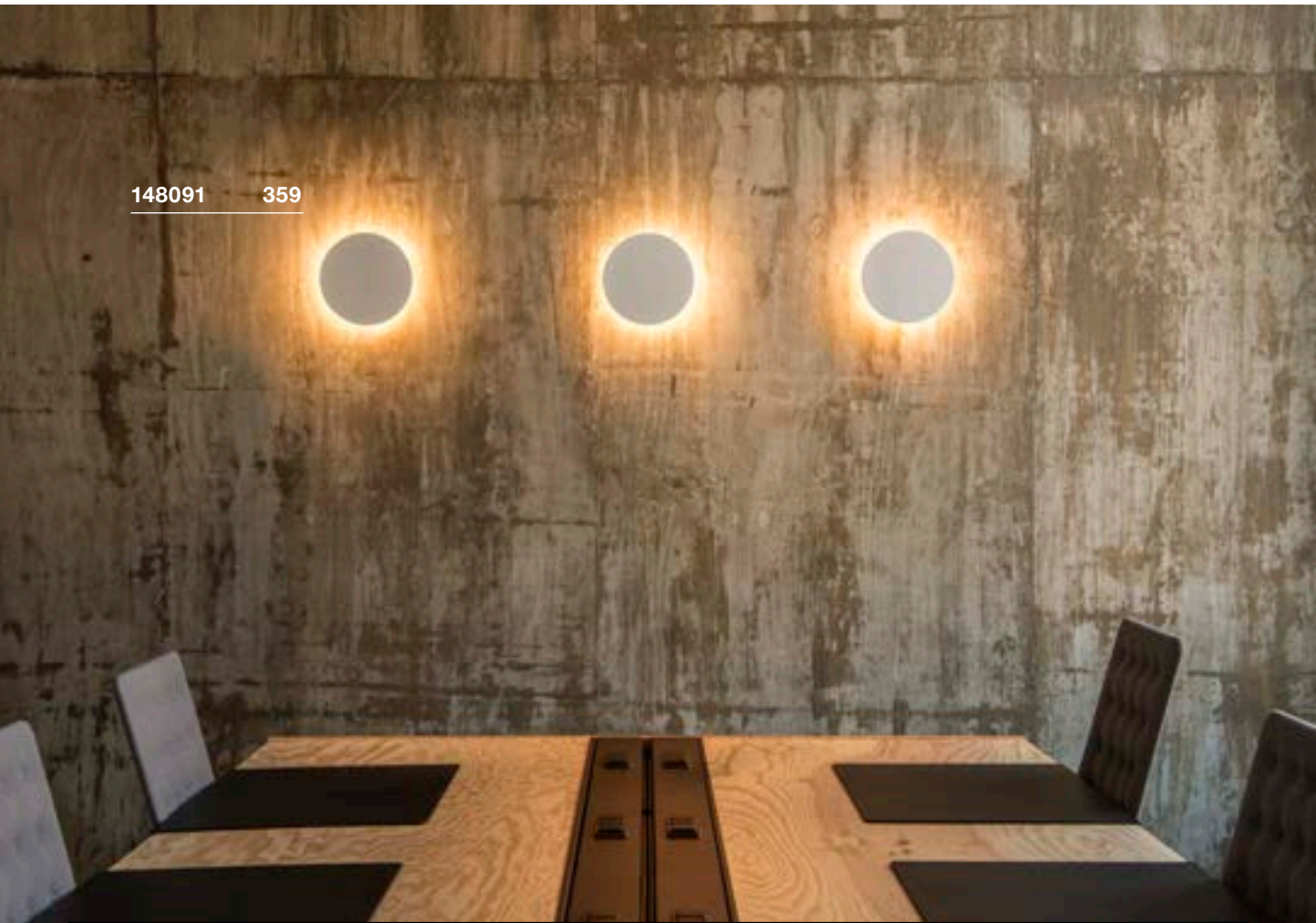



PLASTRA
WL, semicircular

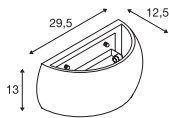

220-240V ~50/60Hz
Material: plaster/steel

- Can be painted over/wallpapered to match wall colour



Base: 1xR7s 118mm | Max. diameter: 2 cm | L: 11.8 cm

Options	Prod. no.
<input type="radio"/> white	1004732

PLASTRA
WL, round shield

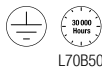
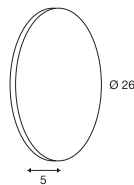

100-240V ~50/60Hz | 12V
Total wattage: 6.5W
Material: plaster/steel

- Can be painted over/wallpapered to match wall colour



Down | 375lm | 3000K

Options	Prod. no.
<input type="radio"/> white	148091

PLASTRA
WL, square

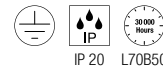
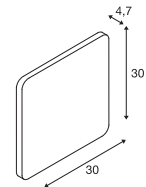

100-240V ~50/60Hz | 12V
Total wattage: 10.5W
Material: plaster/steel

- Can be painted over/wallpapered to match wall colour



Down | 650lm | 3000K

Options	Prod. no.
<input type="radio"/> white	148019



LED R7s | 15W | 330°
3000K | 2000lm | EEK=E
15kWh/1000h



Prod. no.: 1005288



148060 360

PLASTRA
WL, QPAR51

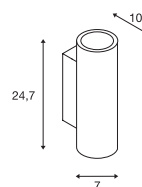

148013 361



220-240V ~50/60Hz
Material: plaster/steel

- Can be painted over/wallpapered to match wall colour

SOCKET
INSIDE <35
W

Base: 2xGU10

Options	Prod. no.
<input type="radio"/> white	148060



LED GU10 51mm | 6W | 36°
2200-2700K | 360lm | EEC=G



Prod. no.: 1005273



PLASTRA 101
WL, E14

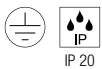
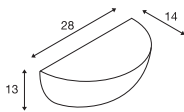

220-240V ~50/60Hz
Material: plaster/steel

- Can be painted over/wallpapered to match wall colour



Base: 1xE14 Max. Ø: 4.5 cm L: 11 cm

Options	Prod. no.
<input type="radio"/> white	148013



C35 | 4.2W | 320°
2700K | 350lm | EEK=G
5kWh/1000h



Prod. no.: 1005285

PLASTRA
WL, Curve, QT-DE12

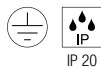
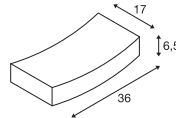

220-240V ~50/60Hz
Material: plaster/steel

- Can be painted over/wallpapered to match wall colour



Base: 1xR7s 78mm

Options	Prod. no.
<input type="radio"/> white	148012



LED R7s | 9W | 330°
3000K | 1050lm | EEK=E
9kWh/1000h



Prod. no.: 1005287

PLASTRA 104
WL, QT14

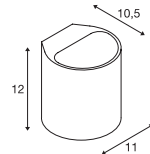

220-240V ~50/60Hz
Material: plaster/steel

- Can be painted over/wallpapered to match wall colour



Base: 1xG69

Options	Prod. no.
<input type="radio"/> white	148016



LED G9 | 3.6W | 300°
3000K | 400lm | EEK=E
4kWh/1000h



Prod. no.: 1005286

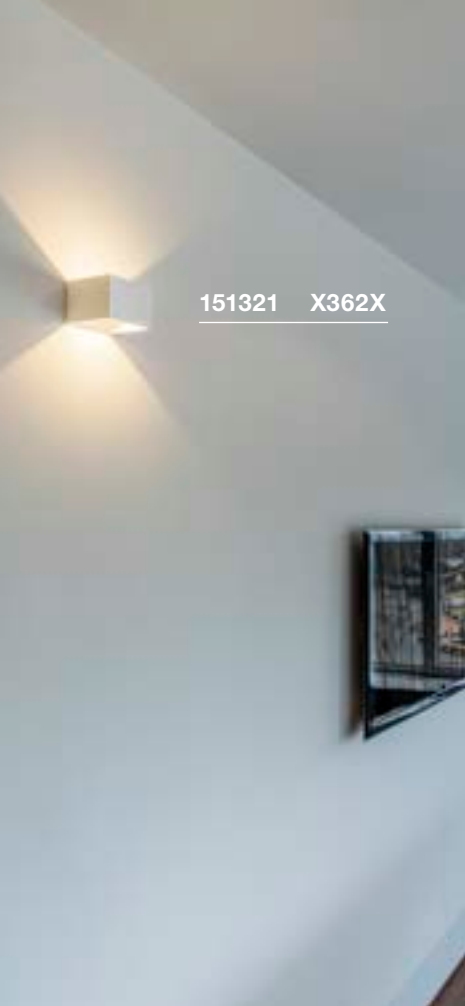

151321 X362X



1000638 362

LOGS IN WL

LOGS IN WL, PHASE

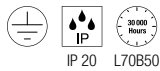
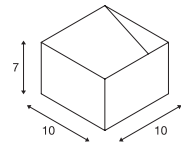
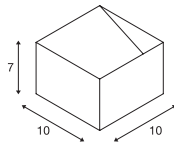

IP 20 L70B50

100-240V ~50/60Hz | 500mA
Total wattage: 6W
Material: aluminium



Down 300lm | 3000K
470lm

Options	Prod. no.
● black/gold 300lm	151320
○ white 470lm	151321

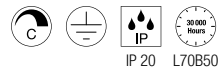

IP 20 L70B50

220-240V ~50/60Hz | 250mA
Total wattage: 11W
Material: aluminium



Down 430-690lm | 2000-3000K

Options	Prod. no.
● black/gold 430lm	1000638
○ white 690lm	1000639
○ aluminium/white 690lm	1000640



1002843 363

LOGS IN L
WL, PHASE

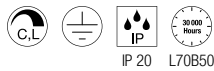
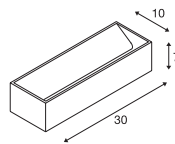

220-240V ~50/60Hz | 500mA
Total wattage: 18W
Material: aluminium



Down 1100lm | 1600lm | 3000K

Options	Prod. no.
● black/gold 1100lm	1002842
○ white 1600lm	1002844
○ aluminium/white 1600lm	1002843

LOGS IN L
WL, PHASE

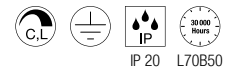
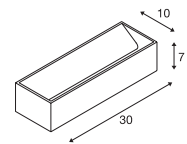

220-240V ~50/60Hz | 500mA
Total wattage: 21W
Material: aluminium



Down 1000lm | 2000-3000K

Options	Prod. no.
● black/gold 1000lm	1002928
○ white 1390lm	1002929



1002928 363



1003467 364

QUAD FRAME 14 WL

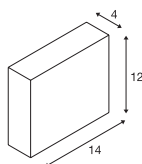

100-240V ~50/60Hz | 350mA
Total wattage: 4.4W
Material: aluminium



Down 165lm | 2700K | 175lm | 3000K

Options	Prod. no.
<input type="radio"/> white	1003467

QUAD FRAME 19 WL

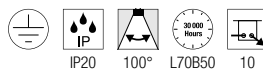
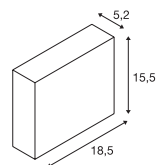

220-240V ~50/60Hz | 500mA
Total wattage: 11W
Material: aluminium



Down 580lm | 2700K | 640lm | 3000K

Options	Prod. no.
<input type="radio"/> white	1003468



1003468 364



1000422 365

SHELL 15
WL, PHASE

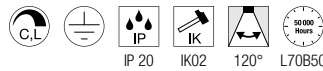
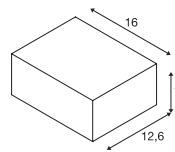

220-240V ~50/60Hz | 350mA
Total wattage: 15W
Material: aluminium/acrylic



Down 1400lm | 3000K

Options	Prod. no.
<input type="radio"/> white	1000422

SHELL 30
WL, PHASE

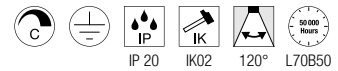
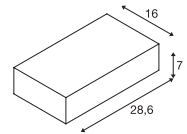

220-240V ~50/60Hz | 700mA
Total wattage: 54W
Material: aluminium/acrylic



Down 5600lm | 3000K

Options	Prod. no.
<input type="radio"/> white	1000423



1000423 365



151275 366

ASSO 300
WL, PHASE

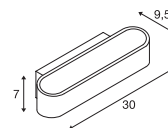

151410 366

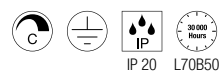

220-240V ~50/60Hz | 500mA
Total wattage: 12W
Material: aluminium/steel



Down

975lm | 3000K

Options	Prod. no.
<input type="radio"/> white	151271
<input checked="" type="radio"/> aluminium/white	151275



ASSO 300
WL, PHASE

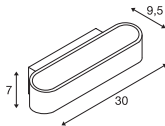

220-240V ~50/60Hz | 500mA
Total wattage: 21W
Material: aluminium/steel



Down 1340lm | 2000-3000K

Options	Prod. no.
<input type="radio"/> white	1000634

OSSA 180
WL, QT-DE12

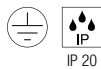
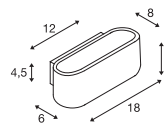

220-240V ~50/60Hz
Material: aluminium/steel



Base: 1xR7s 78mm

Options	Prod. no.
<input checked="" type="radio"/> black	151450
<input type="radio"/> white	151451
<input type="radio"/> aluminium	151456



LED R7s | 9W | 330°
3000K | 1050lm | EEK=E
9kWh/1000h

Prod. no.: 1005287



OSSA 300
WL, QT-DE12

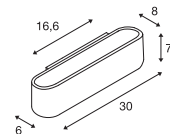

220-240V ~50/60Hz
Material: aluminium/steel



Base: 1xR7s 118mm

Options	Prod. no.
<input checked="" type="radio"/> black	151410
<input type="radio"/> white	151411



LED R7s | 15W | 330°
3000K | 2000lm | EEK=E
15kWh/1000h

Prod. no.: 1005288



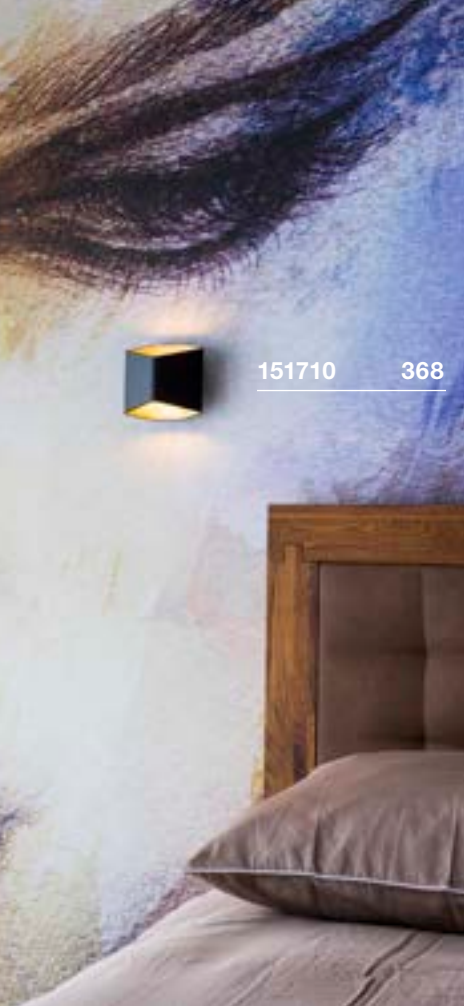

151710 368



151740 368

CARISO WL, PHASE

CARISO WL, PHASE

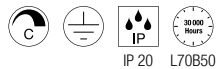
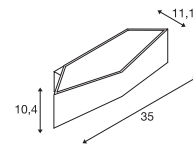
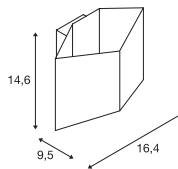

IP 20 L70B50

220-240V ~50/60Hz | 500mA
Total wattage: 9,2W
Material: aluminium/steel



IP 20 L70B50

220-240V ~50/60Hz | 500mA
Total wattage: 21W
Material: aluminium/steel



Down 250lm | 2700K
560lm | 3000K

Options	Prod. no.
● black/gold 250lm 2700K	151710
○ white 560lm 3000K	151711



Down 580lm | 1700-2700K
1030lm | 2000-3000K

Options	Prod. no.
● black/gold 580lm 1700-2700K	151740
○ white 1030lm 2000-3000K	151741



CHROMBO WL, PHASE

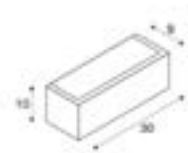

1003317 369

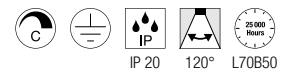

220-240V ~50/60Hz | 350mA
Total wattage: 11W
Material: steel/glass



Down

700lm | 3000K

Options	Prod. no.
○ white	1003316
● grey	1003317

DIRETO 60
WL, PHASE

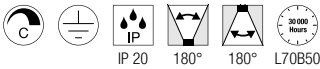
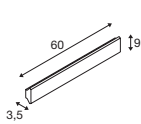

220-240V ~50/60Hz | 500mA
Total wattage: 14W
Material: aluminium



Up 590lm | 2700K | 625lm | 3000K
Down

Options	Prod. no.
● black	1004740
○ white	1004741

DIRETO 90
WL, PHASE

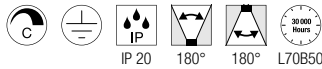
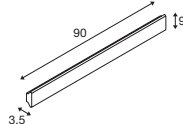

220-240V ~50/60Hz | 500mA
Total wattage: 20W
Material: aluminium



Up 840lm | 2700K | 880lm | 3000K
Down

Options	Prod. no.
● black	1004742
○ white	1004743

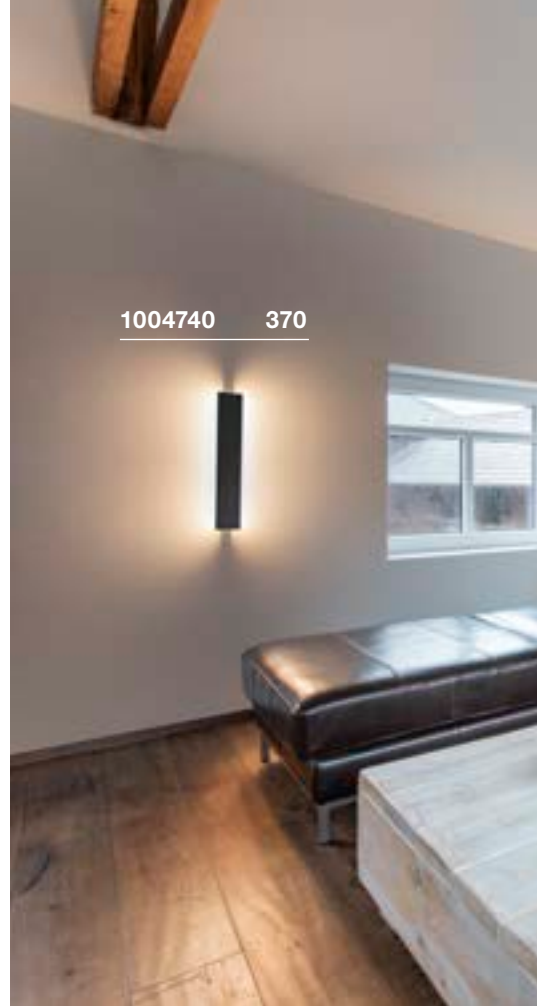

1004740 370



1004743 370



ARLINA 60
WL

ARLINA 130
WL

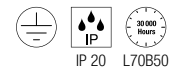
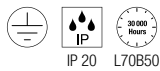
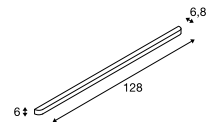
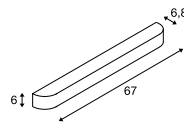

220-240V ~50/60Hz | 500mA
Total wattage: 23W
Material: aluminium/glass

220-240V ~50/60Hz | 700mA
Total wattage: 28W
Material: aluminium/glass



Down 1550lm | 3000K

Down 2400lm | 3000K

Options	Prod. no.
● aluminium	1002239

Options	Prod. no.
● aluminium	1002240



147529 373

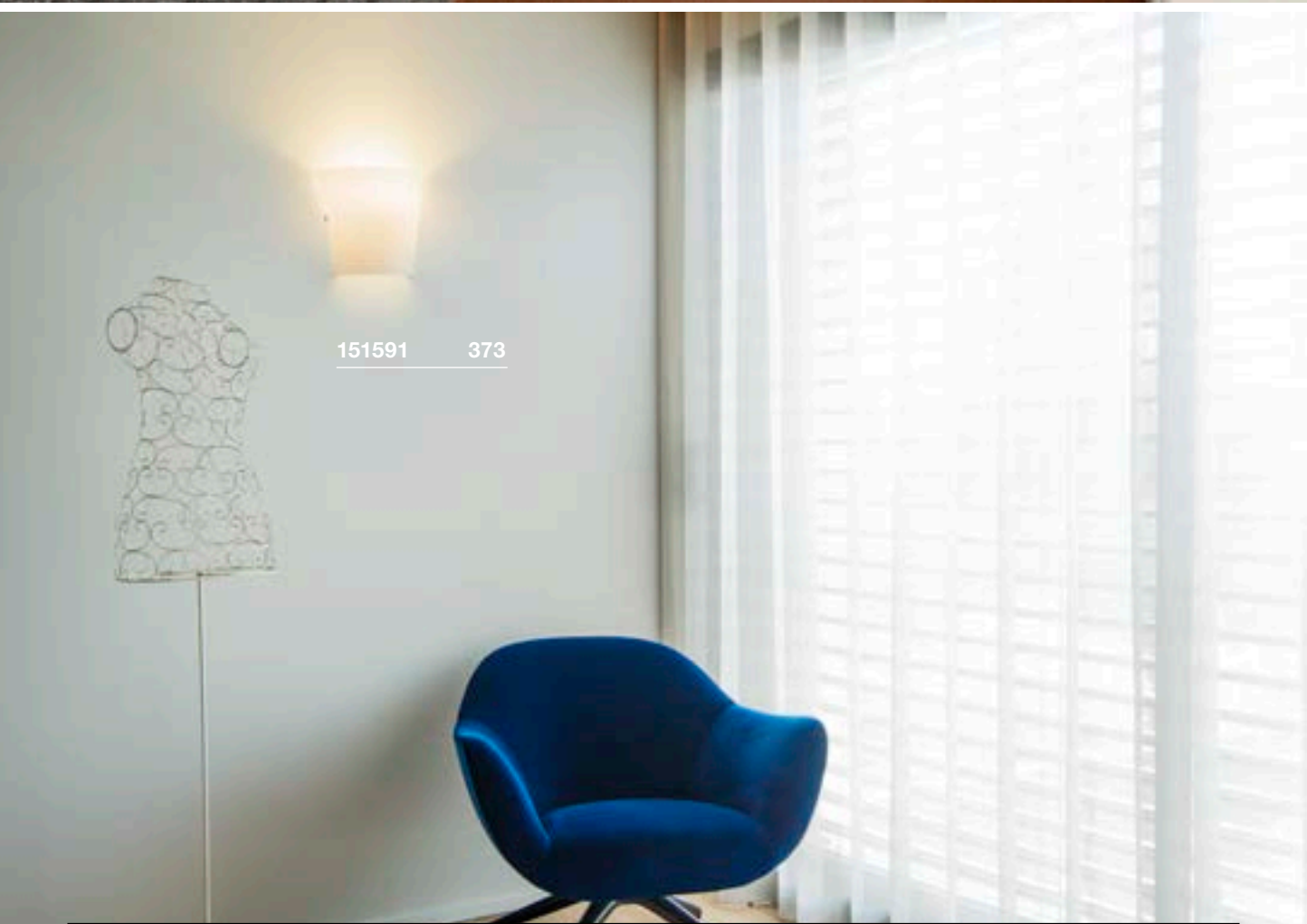

151591 373



ANDREAS
WL, QT-DE12

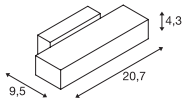

220-240V ~50/60Hz
Material: aluminium/steel



Base: 1xR7s 118mm

Options	Prod. no.
● black	1002927
○ white	1002925



LED R7s | 15W | 330°
3000K | 2000lm | EEK=E
15kWh/1000h



Prod. no.: 1005288

DENA 30
WL, E14

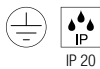
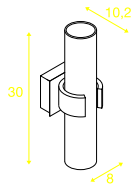

220-240V ~50/60Hz
Material: aluminium



Base: 2xE14 Max. Ø: 5.1 cm L: 9.6 cm

Options	Prod. no.
● aluminium	147529



C35 | 4.2W | 320°
2700K | 350lm | EEK=G
5kWh/1000h



Prod. no.: 1005285

BASKET
WL, E27

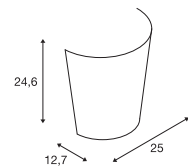

220-240V ~50/60Hz
Material: glass



Base: 1xE27 Max. Ø: 5.2 cm L: 15.2 cm

Options	Prod. no.
○ white	151591



LED E27 | 8W | 240°
3000K | 880lm | EEK=E
8kWh/1000h



Prod. no.: 1005289

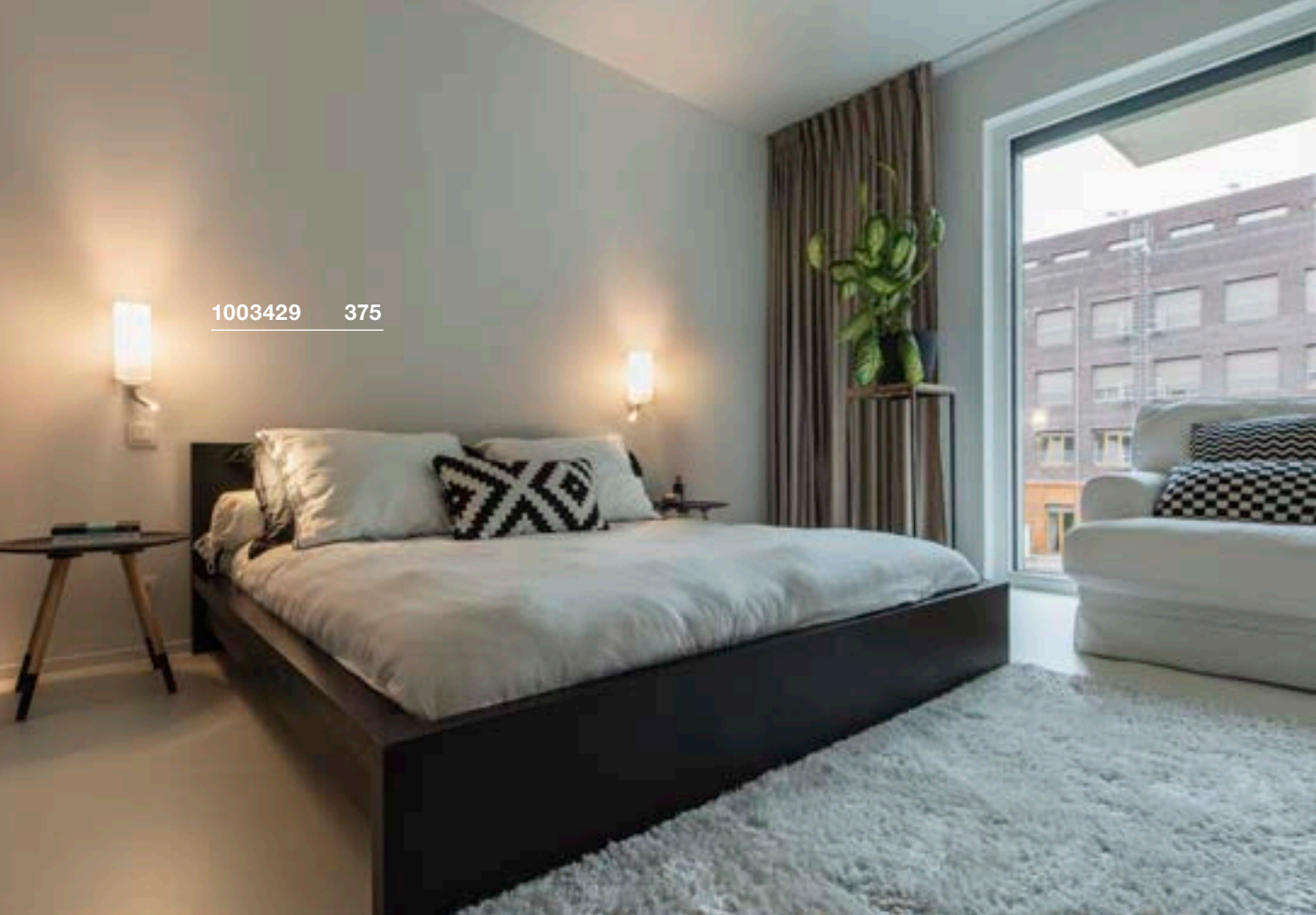

1003429 375

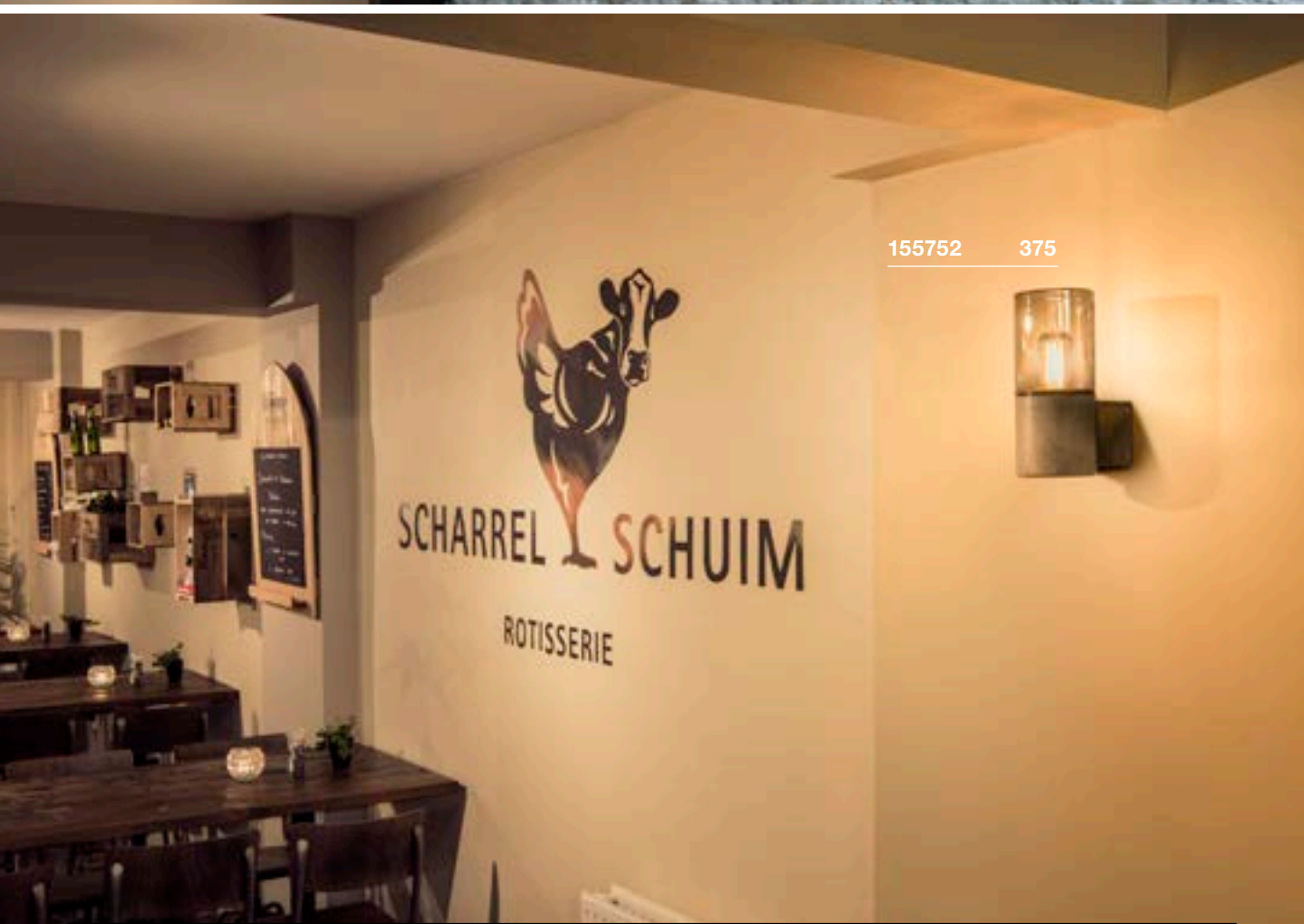

155752 375



QUADRASS WL, E27

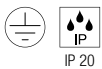
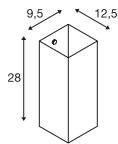

220-240V ~50/60Hz
Material: steel/glass



Base: 1xE27 Max. Ø: 6.5 cm L: 18 cm

Options	Prod. no.
● black/opaque	1003430
○ white/opaque	1003431



LED E27 | 13.2W | 220°
2700K | 1300lm | EEK=F
13kWh/1000h

Prod. no.: 1005302



QUADRASS SPOT WL, E27

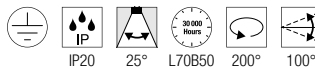
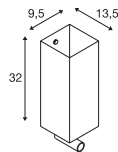

100-240V ~50/60Hz | 700mA
Total wattage: 2W
Material: steel/glass

- Switch on light housing
- Lightbulbs can be switched on/off separately



Down 200lm | 3000K



Base: 1xE27 Max. Ø: 6.5 cm L: 18 cm

Options	Prod. no.
● black	1003428
○ white	1003429



A60 | 7.5W | 320°
2700K | 800lm | EEK=F
8kWh/1000h

Prod. no.: 1005303



LISENNE WL, E27

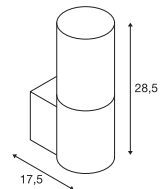

220-240V ~50/60Hz
Material: basalt/glass



Base: 1xE27 Max. Ø: 5.9 cm L: 15 cm

Options	Prod. no.
● grey/brown	155752



LED E27 | 8W | 240°
3000K | 880lm | EEK=E
8kWh/1000h

Prod. no.: 1005289



FITU
Wall bracket

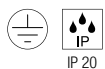
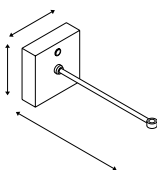

Material: steel

- See page 295 for matching pendant lights

FITU CUBE
WL, E27

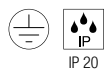
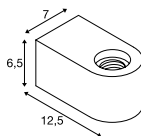

220-240V ~50/60Hz
Material: steel



Base: 1xE27

Max. Ø: 12.5 cm

Options	Prod. no.
● black	1004682

Options	Prod. no.
● black	1004738
○ white	1004739



A60 | 7.5W | 180°
2700K | 720lm | EEK=F
8kWh/1000h

Prod. no.: 1005305

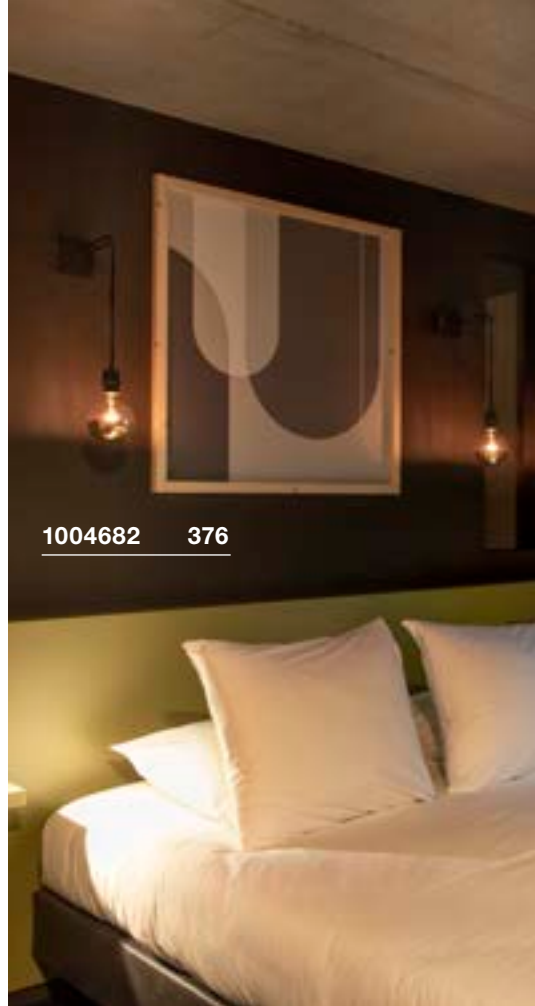

1004682 376

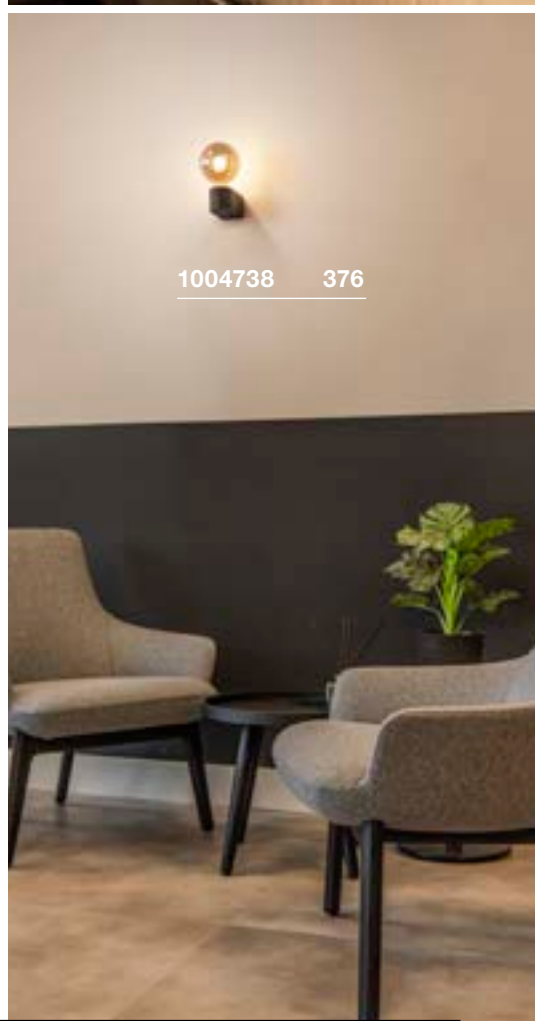

1004738 376



1000327 377

THEO UP/DOWN
WL, QPAR51

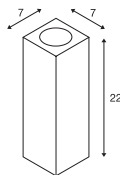

220-240V ~50/60Hz
Material: aluminium



Base: 2xGU10

Options	Prod. no.
● anthracite	1000330
○ white	1000327
● aluminium	1000329



LED GU10 51mm | 6W | 38°
2700K | 450lm | EEK=F
6kWh/1000h



Prod. no.: 1005077

SOLID CUBE
WL, QT14

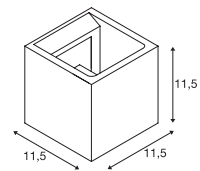

220-240V ~50/60Hz
Material: concrete



Base: 1xG69

Options	Prod. no.
● grey	1000910
● black	1000911



LED G9 | 3,6W | 300°
3000K | 400lm | EEK=E
4kWh/1000h



Prod. no.: 1005286



1000910 377

151803 379





ENOLA B
WL, QPAR51

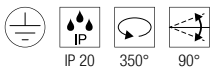
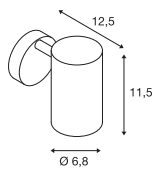

220-240V ~50/60Hz
Material: aluminium/steel

- Switch on light housing



Base: 1xGU10 max. L: 6 cm

Options	Prod. no.
● black	1000729
○ white	1000730



LED GU10 51mm | 6W | 38°
2700K | 450lm | EEK=F
6kWh/1000h



Prod. no.: 1005077



Product	Prod. no.
Decorative ring, black	
● black	151840

ENOLA B
WL, QPAR51

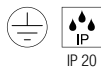
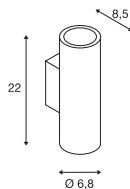

220-240V ~50/60Hz
Material: aluminium/steel



Base: 2xGU10 max. L: 8.5 cm

Options	Prod. no.
● black	151800
○ white	151801
● gold	151803



LED GU10 51mm | 6W | 38°
2700K | 450lm | EEK=F
6kWh/1000h



Prod. no.: 1005077



Product	Prod. no.
Decorative ring, black	
● black	151840

ASTINA UP/DOWN
WL, QPAR51

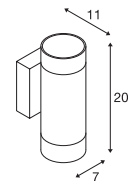

220-240V ~50/60Hz
Material: aluminium/steel



Base: 2xGU10

Options	Prod. no.
● black	1002933
○ white	1002931



LED GU10 51mm | 6W | 36°
2200-2700K | 360lm | EEK=G



Prod. no.: 1005273

FENDA
WL, Base, E27

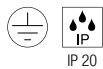
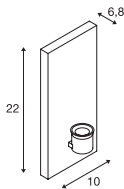



220-240V ~50/60Hz
Material: steel/plastic



Base: 1xE27 Max. Ø: 5.1 cm L: 20 cm

Options	Prod. no.
<input type="radio"/> white	1001272

 LED E27 | 8W | 240°
3000K | 880lm | EEK=E
8kWh/1000h

Prod. no.: 1005289

FENDA
Half shade



W: 23 cm H: 30 cm D: 12 cm
Material: textile/steel

Options	Prod. no.
<input checked="" type="radio"/> black	1001273
<input checked="" type="radio"/> black/copper	1001274
<input type="radio"/> white	1001275
<input type="radio"/> beige	1001276

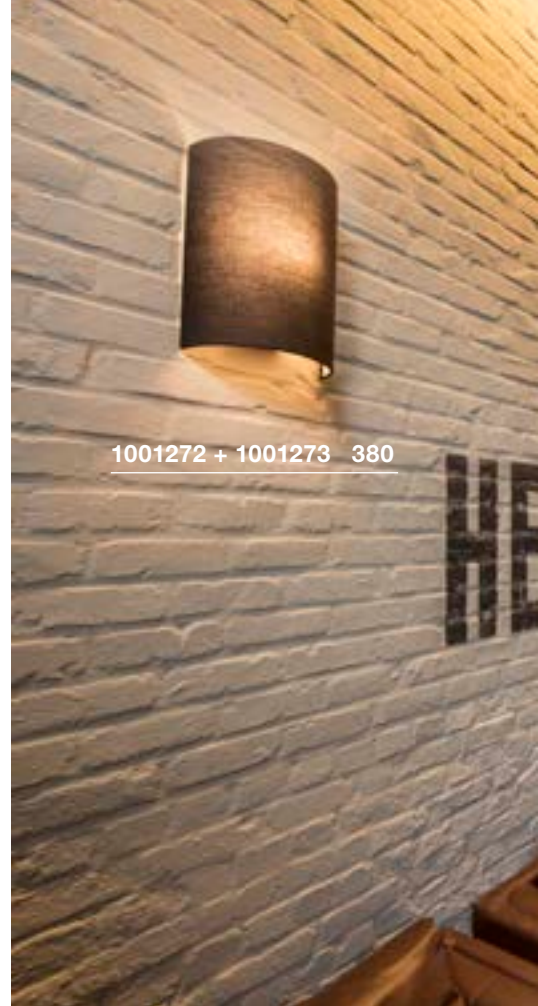

1001272 + 1001273 380



149452 381



KENKUA SPOT
WL, E27

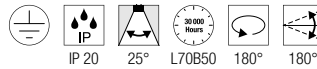
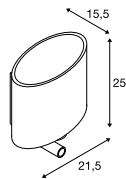

100-240V ~50/60Hz | 700mA
Total wattage: 2W
Material: steel/glass

- Light sources can be switched on/off separately at the light.



Down 200lm | 3000K



Base: 1xE27 Max. Ø: 6.5 cm | L: 12 cm

Options	Prod. no.
● chrome	1002855



A60 | 7.5W | 320°
2700K | 800lm | EEK=F
8kWh/1000h

Prod. no.: 1005303



COUPA FLEX
WL

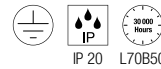
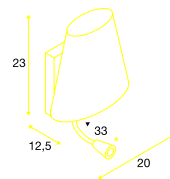

220-240V ~50/60Hz | 700mA
Total wattage: 3.2W
Material: steel/glass

- Light sources can be switched on/off separately at the light.



Down 140lm | 3000K



Base: 1xG69 max. L: 9 cm

Options	Prod. no.
● chrome/opaque	149452



LED G9 | 3.6W | 300°
3000K | 400lm | EEK=E
4kWh/1000h

Prod. no.: 1005286



KARPO MAGN
CW, single, PHASE

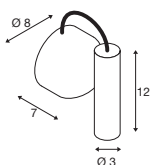

220-240V ~50/60Hz | 500mA
Total wattage: 6.2W
Material: steel/aluminium

- Lamp head position can be adjusted via the magnetic bracket



Down 350lm | 430lm | 3000K

Options	Prod. no.
● black 350lm	1004706
○ white 430lm	1004707

KARPO GOOSE
WL

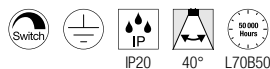
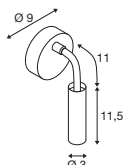

220-240V ~50/60Hz | 12V
Total wattage: 5.8W
Material: aluminium/steel

- Light can be dimmed via switch on the lamp head



Down 380lm | 420lm | 3000K

Options	Prod. no.
● black 380lm	1006162
○ white 420lm	1006161

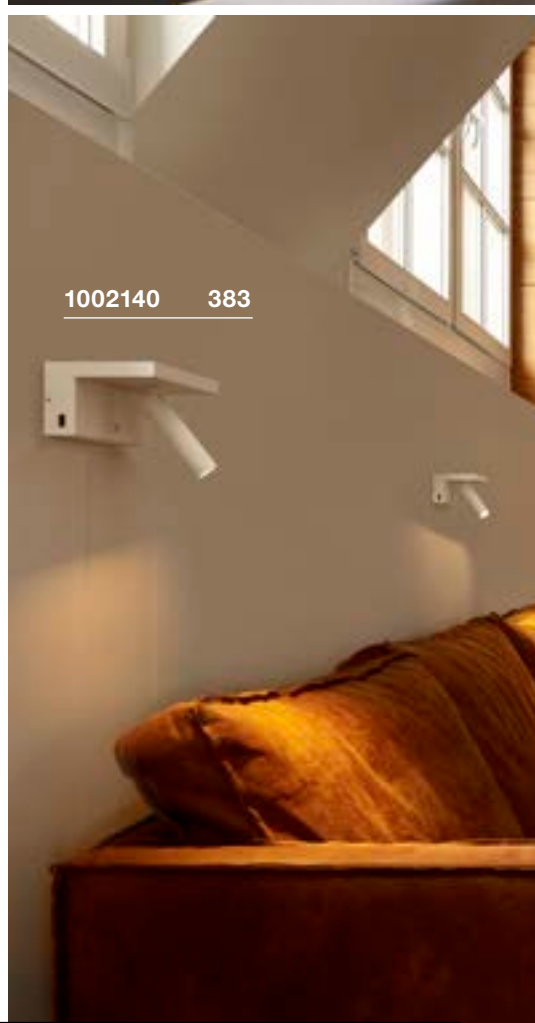

1002140 383



KARPO 30
WL, single

KARPO
WL



1004707 382

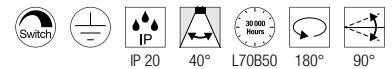
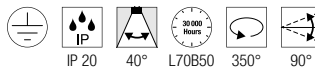
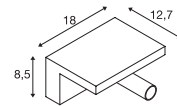
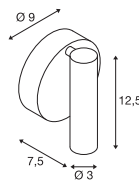

100-240V ~50/60Hz | 500mA
Total wattage: 6W
Material: aluminium/steel

220-240V ~50/60Hz | 500mA
Total wattage: 6.8W
Material: aluminium

- Switch on light housing

- 2 USB connections 1.5 A max
- 3 dimming levels via switch on base



Down 370lm | 400lm | 3000K

Down 390lm | 3000K

Options	Prod. no.
● black 370lm	152340
○ white 400lm	152341

Options	Prod. no.
○ white	1002140





1003457 384

SOMNILA SPOT WL, left

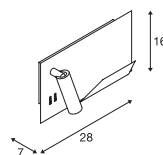

1003459 385

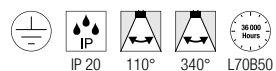

100-240V ~50/60Hz | 12V
Total wattage: 15W
Material: aluminium/steel

- 1 USB connection
- Light sources can be switched on/off separately on the housing



Down

120lm | 3000K

Options	Prod. no.
● black 490lm	1003455
○ white 770lm	1003457



SOMNILA SPOT WL, right

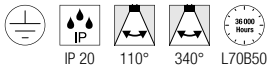
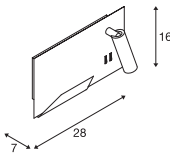

100-240V ~50/60Hz | 12V
Total wattage: 15W
Material: aluminium/steel

- 1 USB connection
- Light sources can be switched on/off separately on the housing



Down 120lm | 3000K

Options	Prod. no.
● black 490lm	1003456
○ white 770lm	1003458

SOMNILA FLEX WL, left

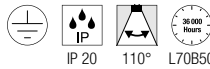
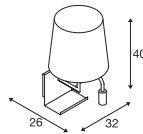

100-240V ~50/60Hz | 12V
Material: aluminium

- Light sources can be switched on/off separately on the housing.



Down 120lm | 3000K



Base: 1xE27 | max. L: 18 cm

Options	Prod. no.
○ white	1003459

SOMNILA FLEX WL, right

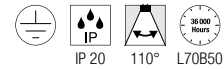
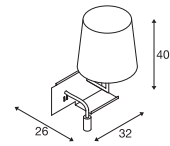

100-240V ~50/60Hz | 12V
Material: aluminium

- Light sources can be switched on/off separately on the housing.



Down 120lm | 3000K



Base: 1xE27 | max. L: 18 cm

Options	Prod. no.
○ white	1003460



1002608 387

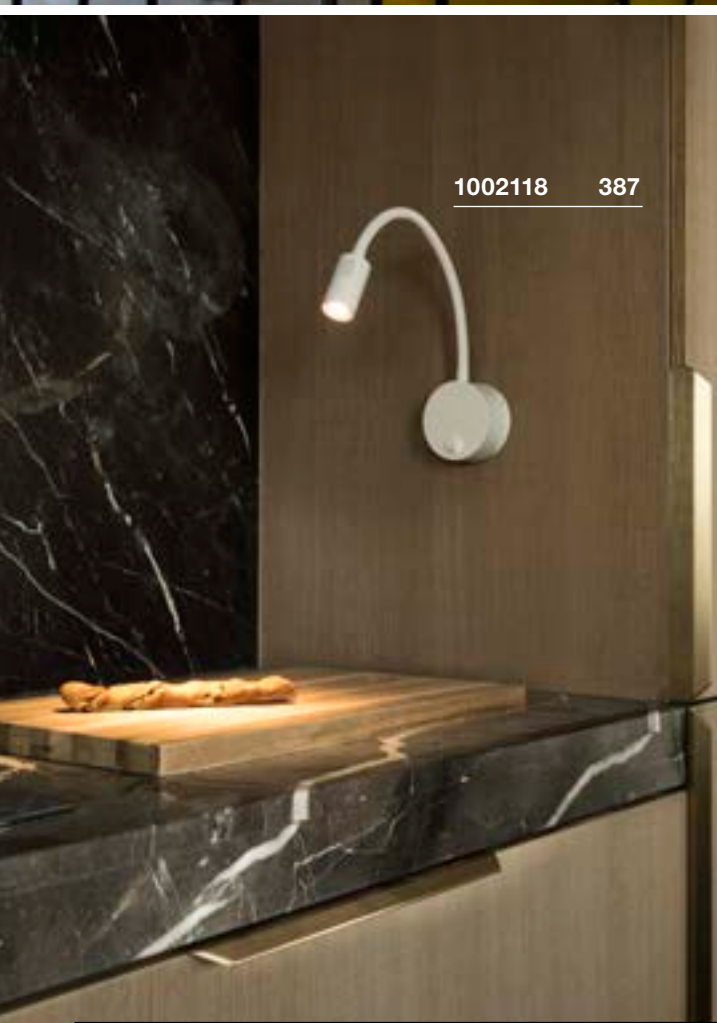

1002118 387

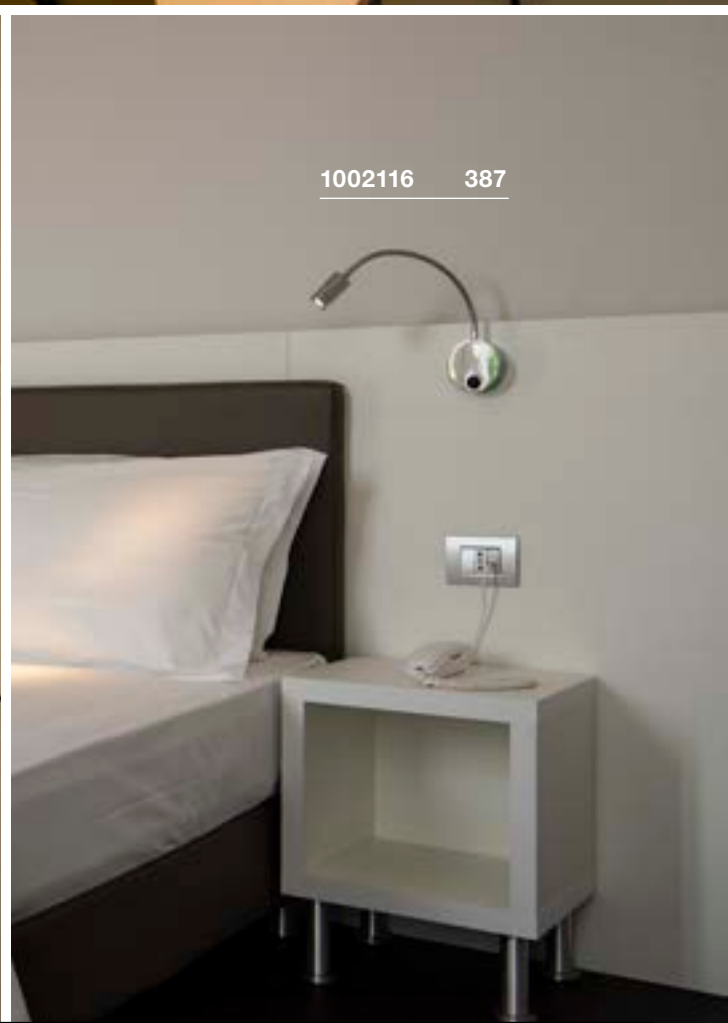

1002116 387



DIO FLEX PLATE
WL QPAR51

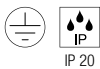
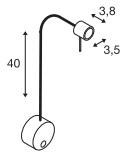

220-240V ~50/60Hz
Material: aluminium

- Switch on light housing
- Decorative ring not included.



Base: 1xGU10

Options	Prod. no.
● black	1002608
○ white	1002607
● chrome	146692



LED GU10 51mm | 6W | 38°
2700K | 450lm | EEK=F
6kWh/1000h

Prod. no.: 1005077



DIO FLEX PLATE
WL

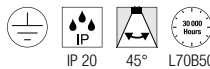
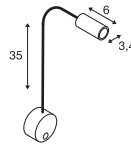

100-240V ~50/60Hz | 350mA
Total wattage: 1.9W
Material: aluminium/glass

- Switch on light housing



Down

100lm

2700K
3000K
4000K

Options	Prod. no.
● black	
2700K	1002430
○ white	
2700K	1002117
● black	
3000K	1002431
○ white	
3000K	1002118
● black	
4000K	1002432
○ white	
4000K	1002119

DIO FLEX PLATE
WL

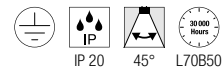
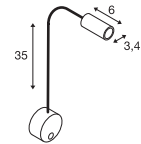

100-240V ~50/60Hz | 350mA
Total wattage: 1.9W
Material: aluminium/glass

- Switch on light housing



Down

100lm

2700K
3000K

Options	Prod. no.
● chrome	
2700K	1002116
● chrome	
3000K	146682

PHELIA
WL, QPAR51

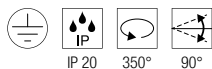
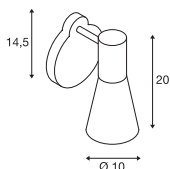

220-240V ~50/60Hz
Material: aluminium/steel

- Switch on light body



Base: 1xGU10 Max. Ø: 5.1 cm L: 10.5 cm

Options	Prod. no.
● black	148540



LED GU10 51mm | 6W | 38°
2700K | 450lm | EEK=F
6kWh/1000h



Prod. no.: 1005077

MERADO FLOOD
WL, PHASE

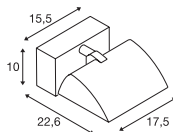

220-240V ~50/60Hz | 1000mA
Total wattage: 40W
Material: aluminium



Down 3000lm | 3000K
3200lm | 4000K

Options	Prod. no.
○ white 3000lm 3000K	1001468
○ white 3200lm 4000K	1001472



148540 388



1001468 388



DISPLAY ADL 50

QPAR51

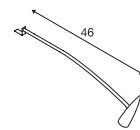

1002860 389



220-240V ~50/60Hz
Material: aluminium/brass

- Open cable end
- Connection box included

SOCKET **INSIDE** <50
W

Base: 1xGU10

Options	Prod. no.
<input type="radio"/> white	1002860
<input checked="" type="radio"/> chrome	146332



LED GU10 51mm | 6W | 36°
2200-2700K | 360lm | EEK=G
6kWh/1000h



Prod. no.: 1005273



NUMINOS®
can be found
on family pages
98–101

LED



MEDO®
can be found
on family pages
148–163

LED



ONE®
can be found
on family pages
192–193

LED



SCKET
PANTILO
ROPE 19 | 393



SCKET
PANTILO
ROPE 27 | 393



LED
CYFT | 395



SCKET
ASTO TUBE | 395



SCKET
ASTO TUBE | 397



SCKET
ASTO TUBE | 397



SCKET
ASTO TUBE | 399



SCKET
ASTO TUBE | 397



LED
OCULUS | 399



LED
KARPO 30 | 399



LED
NOBLO® | 401



LED
NOBLO® | 401



LED
NOBLO® | 401



LED
KALU | 403



LED
KALU | 403



LED
KALU | 403



LED
KALU | 403



SCKET
KALU | 405



SCKET
KALU | 405



SCKET
KALU | 405



SCKET
KALU | 405



SCKET
ENOLA B | 407



SCKET
ENOLA B | 407



SCKET
ENOLA B | 407



SCKET
ALTRA DICE | 408



SCKET
SPOT 79 | 409



SCKET
INDA | 409



SCKET
PURI | 411



SCKET
PURI | 411



SCKET
PURI | 411



SCKET
PURI | 411



SCKET
AVO | 413



SCKET
AVO | 413



SCKET
AVO | 413



SCKET
AVO | 413



SCKET
AVO | 415



SOCKET
ASTO | 415



SOCKET
ASTO | 415



SOCKET
ASTO | 415



LED
SENSER 12 | 417



LED
SENSER 18 | 417



LED
SENSER 24 | 417



LED
SENSER 12 | 419



LED
SENSER 18 | 419



LED
SENSER 24 | 419



LED
SIMA | 420



LED
SIMA | 420



LED
SIMA | 421

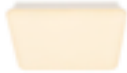

LED
SIMA | 421



LED
LIPSY® 30 | 423



LED
LIPSY® 40 | 423



LED
LIPSY® 50 | 423



LED
LIPSY® 30 | 425



LED
LIPSY® 40 | 425



LED
LIPSY® 50 | 425



LED
LIPSY® 40 | 426



LED
LIPSY® 50 | 426



SOCKET
MELAN | 427



SOCKET
GLASSA | 427



LED
BATTEN 60 | 429



LED
BATTEN 120 | 429



LED
LONG GRILL | 430



LED
SIGHT 60 | 431



LED
SIGHT 115 | 431



LED
BENA 120 | 433



LED
BENA 150 | 433



1007591 393

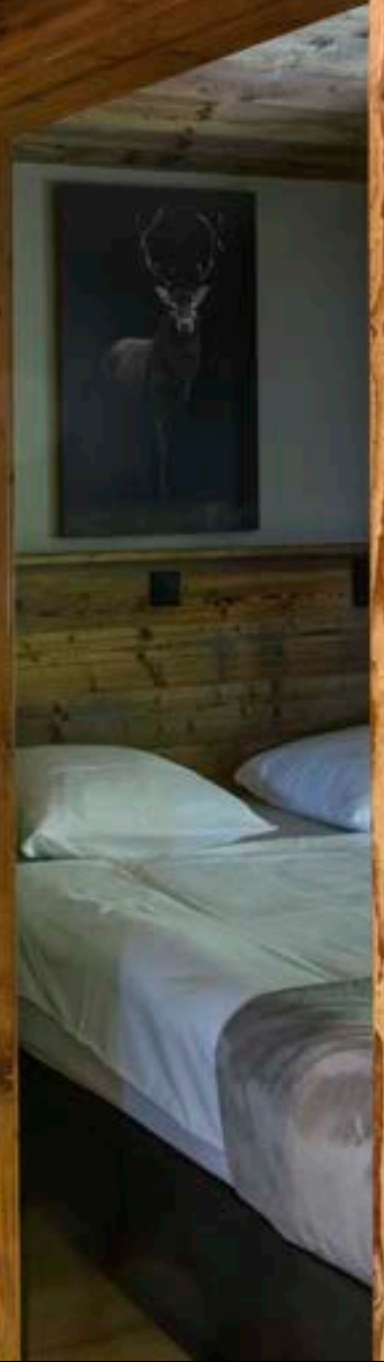



PANTILO ROPE 19
CW, E27

PANTILO ROPE 27
CW, E27

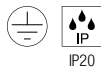
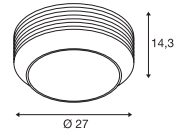
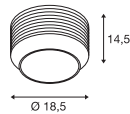

200-240V ~50/60Hz
Material: glass/steel/hemp

200-240V ~50/60Hz
Material: glass/steel/hemp



Base: 1xE27 Max. Ø: 10 cm L: 11 cm

Base: 1xE27 Max. Ø: 15 cm L: 11 cm

Options	Prod. no.
● amber/gold	1007592 ●
● anthracite/silver	1007593 ●

Options	Prod. no.
● amber/gold	1007591 ●
● anthracite/silver	1007590 ●



A60 | 7.5W | 180°
2700K | 720lm | EEK=F
8kWh/1000h



Prod. no.: 1005305



A60 | 7.5W | 180°
2700K | 720lm | EEK=F
8kWh/1000h



Prod. no.: 1005305

1006439 395





CYFT CW



NEW

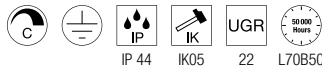
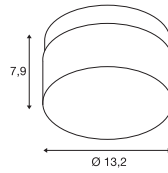

220-240V ~50/60Hz | 500mA
Total wattage: 6.5W
Material: aluminium



330lm | 2700K | 350lm | 3000K | 380lm | 4000K

Options	Prod. no.
● black	1007608 ●

CYFT Decorative ring



NEW

H: 2.45 cm
Diameter: 13.10 cm
Material: steel

Options	Prod. no.
○ white	1007611 ●
● brass	1007610 ●
● chrome	1007609 ●

ASTO TUBE CL, single, GU10



NEW

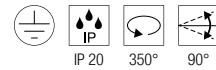
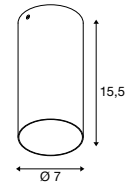

220-240V ~50/60Hz
Material: aluminium



Base: 1xGU10

Options	Prod. no.
● black	1006439 ●
○ white	1006440 ●

ASTO TUBE Decorative reflector



NEW

H: 3.95 cm
Diameter: 6.75 cm
Material: polycarbonate (PC)

Options	Prod. no.
● black/chrome	1007190 ●
● gold	1006450 ●
● chrome	1006449 ●
● copper	1006451 ●

1006423 397



1006428 397

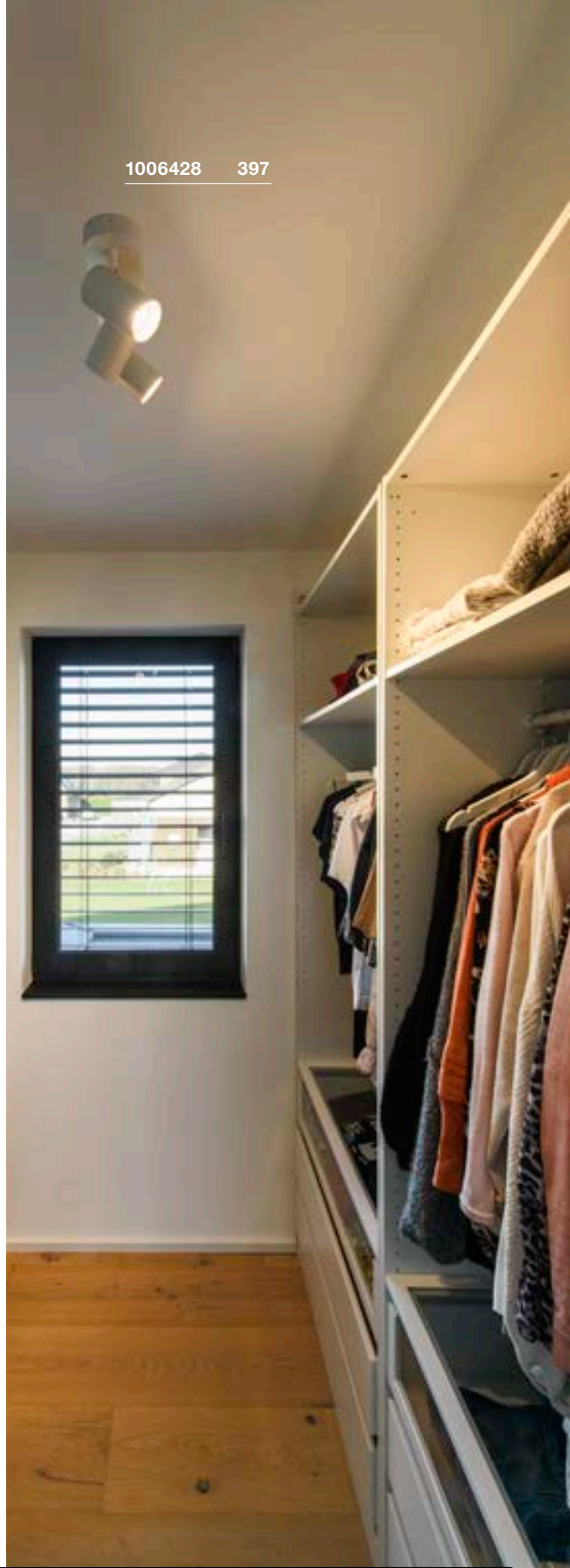



ASTO TUBE

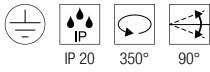

220-240V ~50/60Hz
Material: aluminium



Base: 2xGU10



LED GU10 | 6W | 38°
2700K | 450lm | EEF=F
6kWh/1000h



Prod. no.: 1005076

ASTO TUBE CW, single, GU10

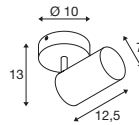

Options	Prod. no.
● black	1006423
○ white	1006424

ASTO TUBE CW, double, GU10

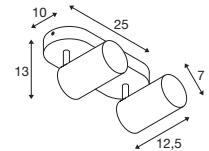

Options	Prod. no.
● black	1006425
○ white	1006426

ASTO TUBE Decorative reflector



H: 3.95 cm
Diameter: 6.75 cm
Material: polycarbonate (PC)

ASTO TUBE CW, triple, GU10

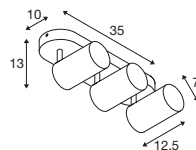

Options	Prod. no.
● black	1006427
○ white	1006428

ASTO TUBE CW, quadruple, GU10

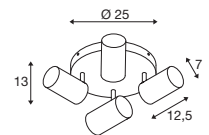

Options	Prod. no.
● black	1006429
○ white	1006430

Options	Prod. no.
● black/chrome	1007190
● gold	1006450
● chrome	1006449
● copper	1006451



1004664 399

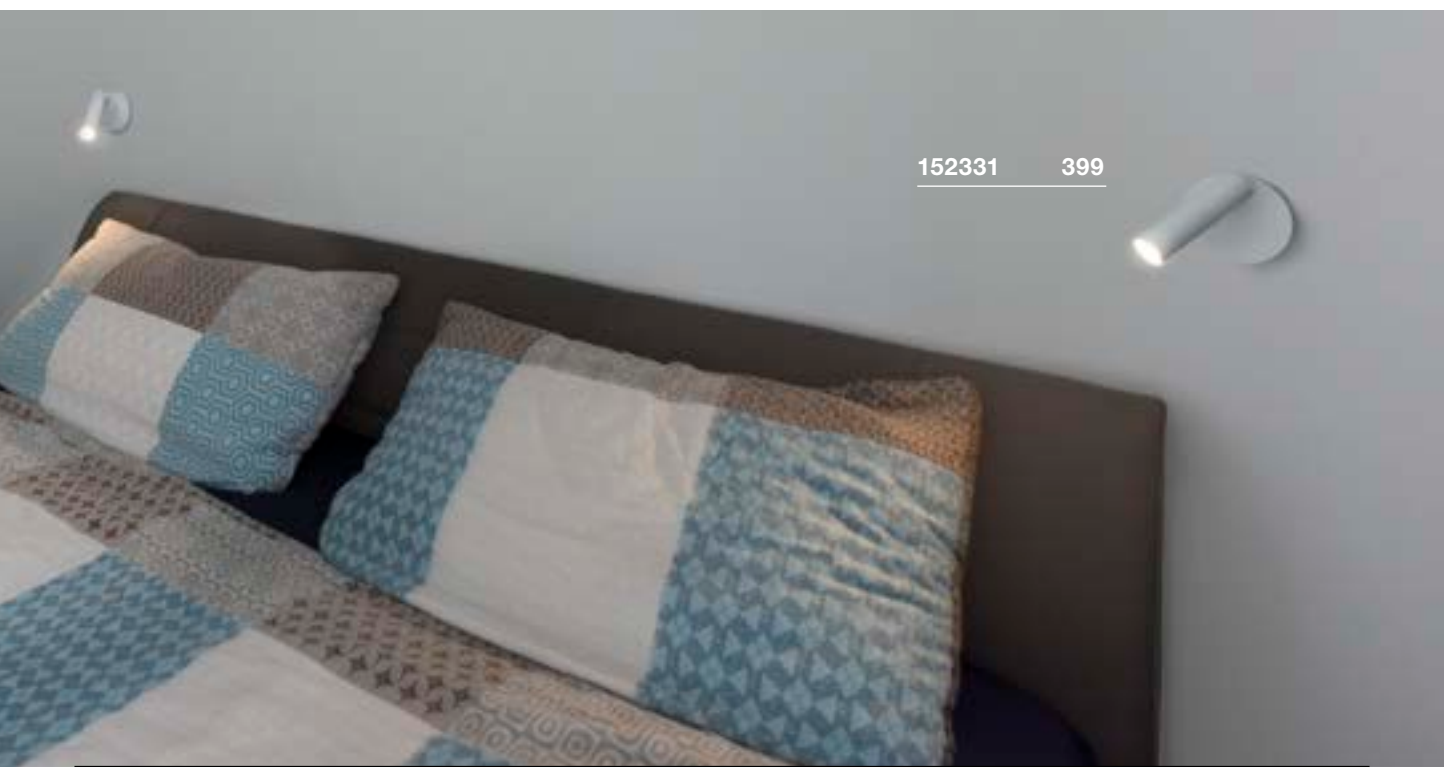

152331 399



OCULUS CW, PHASE

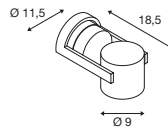

220-240V ~50/60Hz | 250mA
Total wattage: 11W
Material: aluminium/glass

- Additional frosted lens included



Down 36lm | 2000K - 780lm | 3000K

Options	Prod. no.
● black	1004664
○ white	1004665

KARPO 30 CW, single

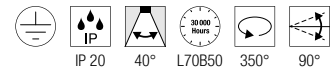
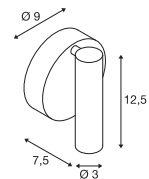

220-240V ~50/60Hz | 500mA
Total wattage: 9.3W
Material: aluminium/steel



Down 560lm | 3000K
680lm

Options	Prod. no.
● black 560lm	152330
○ white 680lm	152331



1002974 401





NOBLO®

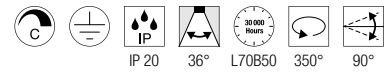

220-240V ~50/60Hz | 350mA
 Total wattage: 8W
 Material: aluminium



Down	620lm	2700K
	1240lm	
	1860lm	

NOBLO® CW, single, PHASE

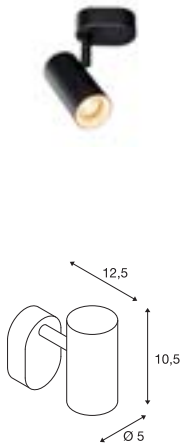

Options	Prod. no.
● black 620lm 2700K 8W	1002969
○ white 620lm 2700K 8W	1002970
● silver 620lm 2700K 8W	1002971

NOBLO® CW, double, PHASE

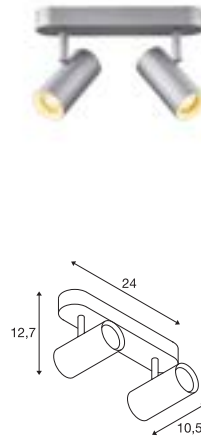

Options	Prod. no.
● black 1240lm 2700K 8W	1002973
○ white 1240lm 2700K 8W	1002974
● silver 1240lm 2700K 8W	1002975

NOBLO® CW, triple, PHASE

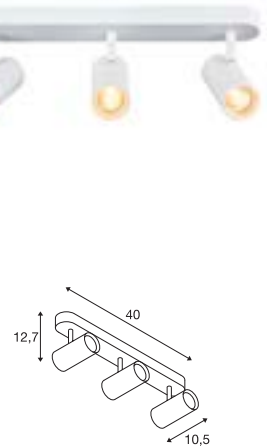

Options	Prod. no.
● black 1860lm 2700K 8W	1002976
○ white 1860lm 2700K 8W	1002977
● silver 1860lm 2700K 8W	1002978

1000131 403





KALU

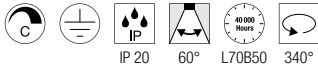

220-240V ~50/60Hz | 350mA
 Total wattage: 17W
 Material: aluminium/polycarbonate (PC)



Down

1000lm | 2000lm | 3000lm | 4000lm | 3000K

KALU CW, single, PHASE

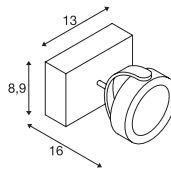

Options	Prod. no.
● black	
1000lm 3000K 17W	1000127
○ white	
1000lm 3000K 17W	1000128

KALU CW, double, PHASE

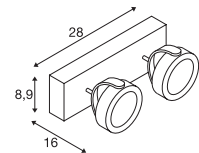

Options	Prod. no.
● black	
2000lm 3000K 17W	1000129
○ white	
2000lm 3000K 17W	1000130

KALU CW, triple, PHASE

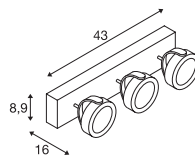

Options	Prod. no.
● black	
3000lm 3000K 17W	1000131
○ white	
3000lm 3000K 17W	1000132

KALU CW, quad, PHASE

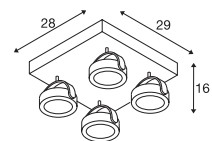

Options	Prod. no.
● black	
4000lm 3000K 17W	1000135
○ white	
4000lm 3000K 17W	1000136

147321 405

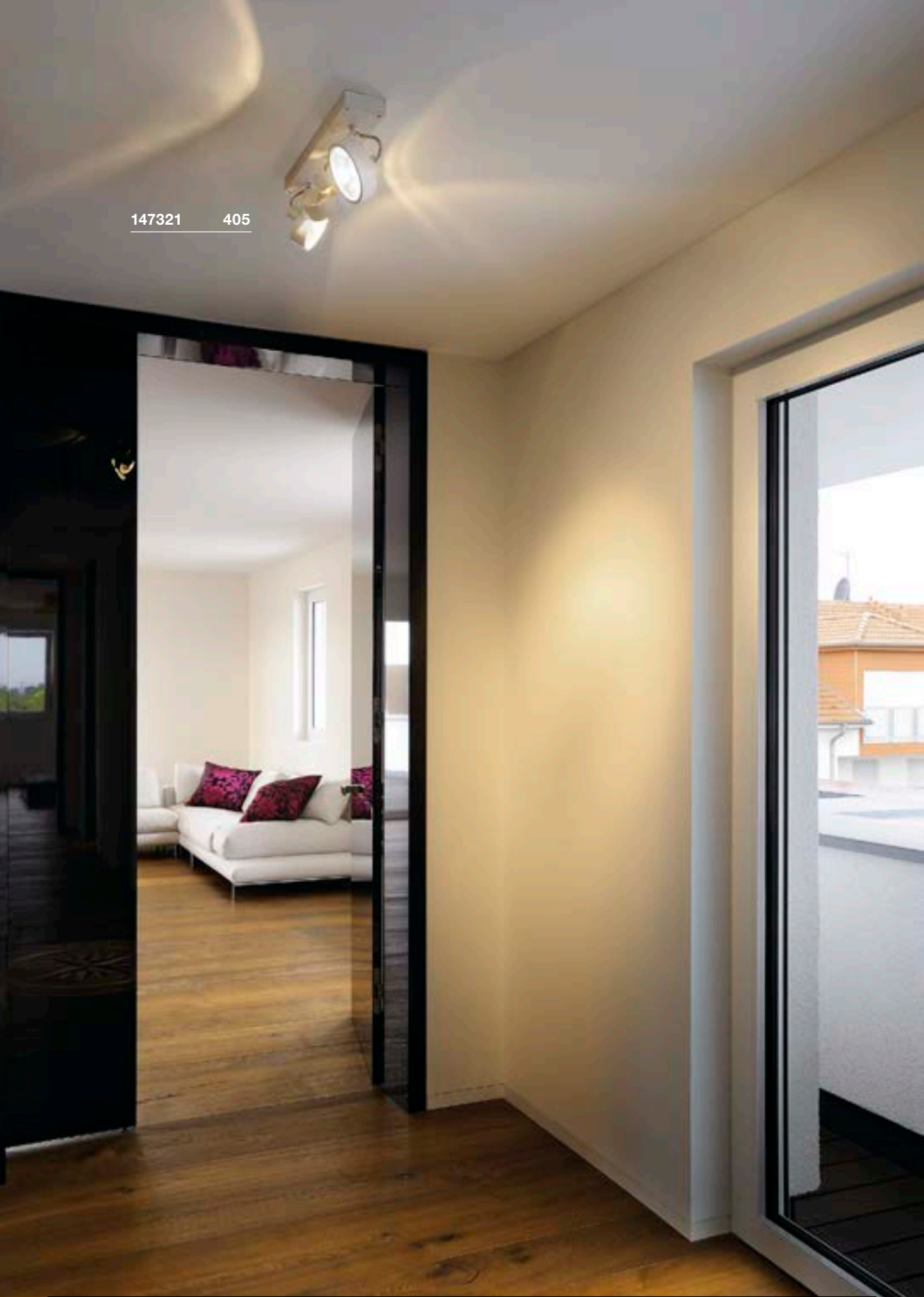



KALU

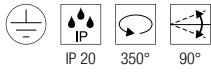

220-240V ~50/60Hz
Material: aluminium



Base: 1xGU10



QPAR111 | 8W | 38°
2700K | 680lm | EEK=F
8kWh/1000h



Prod. no.: 1005274

KALU CW, single, QPAR111

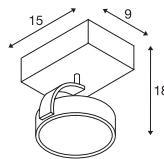

Options	Prod. no.
● black	1000702
○ white	147301
● aluminium	147306

KALU CW, double, QPAR111

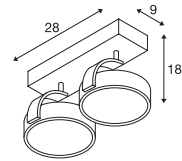

Options	Prod. no.
● black	1000703
○ white	147311
● aluminium	147316

KALU CW, triple, QPAR111

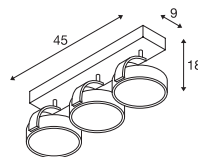

Options	Prod. no.
● black	1000704
○ white	147321
● aluminium	147326

KALU CW, quad, QPAR111

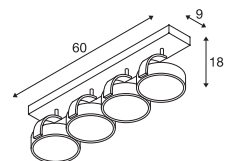

Options	Prod. no.
● black	1002023
○ white	1002024
● aluminium	1002025



152010 407



ENOLA B
CW, single, QPAR51

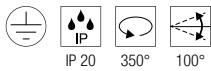
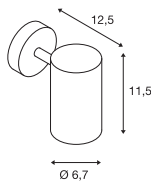

220-240V ~50/60Hz
Material: aluminium/steel

- Decorative ring in light colour included.
- Optional black decorative ring available as an accessory.



Base: 1xGU10 max. L: 6,7 cm

Options	Prod. no.
● black	152010
○ white	152011



LED GU10 51mm | 6W | 38°
2700K | 450lm | EEK=F
6kWh/1000h



Prod. no.: 1005077



Product	Prod. no.
Decorative ring	
● black	151840

ENOLA B
CW, double, QPAR51

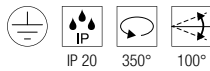
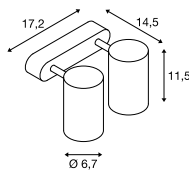

220-240V ~50/60Hz
Material: aluminium/steel

- Decorative ring in light colour included.
- Optional black decorative ring available as an accessory.



Base: 2xGU10 max. L: 6,7 cm

Options	Prod. no.
● black	152020
○ white	152021



LED GU10 51mm | 6W | 38°
2700K | 450lm | EEK=F
6kWh/1000h



Prod. no.: 1005077



Product	Prod. no.
Decorative ring	
● black	151840

ENOLA B
CW, double, QPAR51

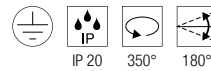
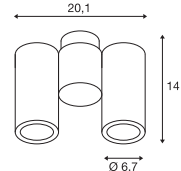

220-240V ~50/60Hz
Material: aluminium/steel

- Decorative ring in light colour included.
- Optional black decorative ring available as an accessory.



Base: 2xGU10 max. L: 8 cm

Options	Prod. no.
● black	151830
○ white	151831



LED GU10 51mm | 6W | 38°
2700K | 450lm | EEK=F
6kWh/1000h



Prod. no.: 1005077



Product	Prod. no.
Decorative ring	
● black	151840

1002215 408



ALTRA DICE CW, double, QPAR51

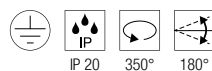
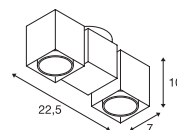

220-240V ~50/60Hz
Material: aluminium/steel

**SECRET
INSIDE** <50
W

Base: 2xGU10

Options	Prod. no.
● black	1002215
○ white	151531
● grey	151534



LED GU10 51mm | 6W | 36°
2200-2700K | 360lm | EEK=G
6kWh/1000h



Prod. no.: 1005273



147551 409



SPOT 79
CW, QPAR51

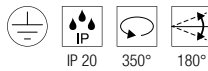
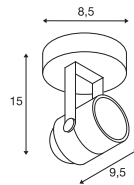

220-240V ~50/60Hz
Material: aluminium

SOCKET INSIDE <50 W

Base: 1xGU10 Max. Ø: 5.1 cm L: 5.7 cm

Options	Prod. no.
● black	132020
○ white	132021
● grey	132024



LED GU10 51mm | 6W | 38°
2700K | 450lm | EEK=F
6kWh/1000h

Prod. no.: 1005077



INDA
CW, QPAR51

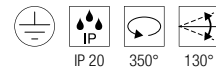
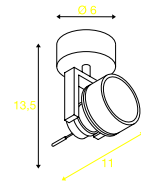

220-240V ~50/60Hz
Material: aluminium

SOCKET INSIDE <50 W

Base: 1xGU10 Max. Ø: 5.1 cm L: 5.7 cm

Options	Prod. no.
● black	147550
○ white	147551
● aluminium	147559



LED GU10 51mm | 6W | 38°
2700K | 450lm | EEK=F
6kWh/1000h

Prod. no.: 1005077







PURI

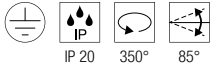

220-240V ~50/60Hz
Material: aluminium/steel

- Decorative ring included.



Base: 1xGU10



LED GU10 51mm | 6W | 38°
2700K | 450lm | EEK=F
6kWh/1000h



Prod. no.: 1005077

PURI CW, single, QPAR51

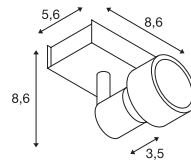

Options	Prod. no.
● black	147360
○ white	147361

PURI CW, double, QPAR51

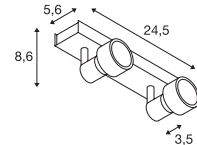

Options	Prod. no.
● black	147370
○ white	147371

PURI CW, triple, QPAR51

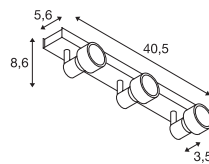

Options	Prod. no.
● black	147380
○ white	147381

PURI CW, quad, QPAR51

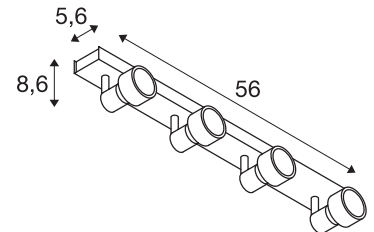

Options	Prod. no.
● black	1002029
○ white	1002030

1000892 413



101

102



AVO

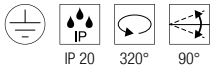

220-240V ~50/60Hz
Material: steel



Base: 1xGU10



LED GU10 51mm | 6W | 38°
2700K | 450lm | EEK=F
6kWh/1000h



Prod. no.: 1005077

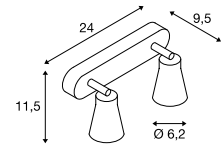
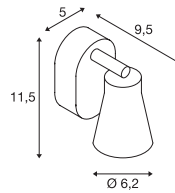

Options	Prod. no.
● black	1000886
○ white	1000887

Options	Prod. no.
● black	1000889
○ white	1000890

AVO CW, triple, QPAR51

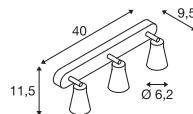

Options	Prod. no.
● black	1000892
○ white	1000893

AVO CW, quad, QPAR51

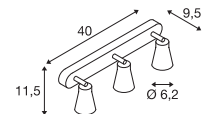

Options	Prod. no.
● black	1000895
○ white	1000896



147443

415





ASTO

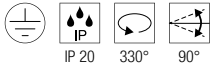

220-240V ~50/60Hz
Material: aluminium



Base: 1xGU10



LED GU10 51mm | 6W | 38°
2700K | 450lm | EEC=F
6kWh/1000h



Prod. no.: 1005075

ASTO CW, single, QPAR51

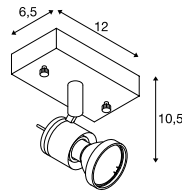

Options	Prod. no.
● aluminium	147441

ASTO CW, double, QPAR51

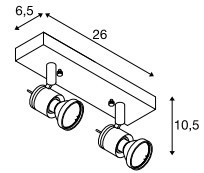

Options	Prod. no.
● aluminium	147442

ASTO CW, triple, QPAR51

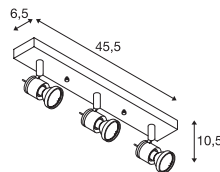

Options	Prod. no.
● aluminium	147443

ASTO CW, quad, QPAR51

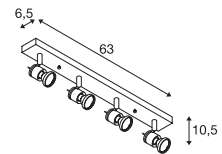

Options	Prod. no.
● aluminium	147444

1004705 417

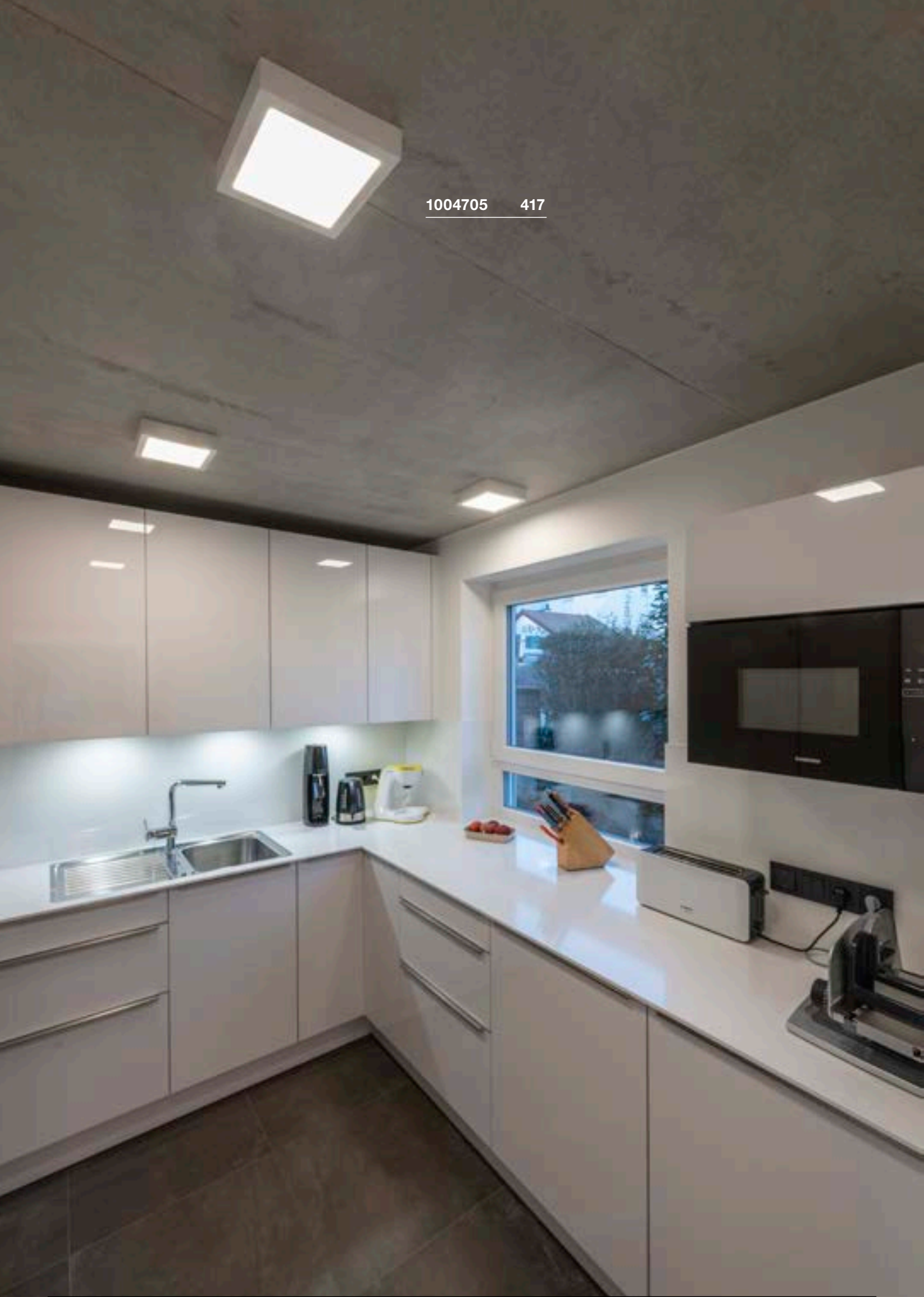



SENSER 12
CW, square, PHASE

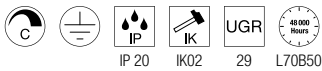
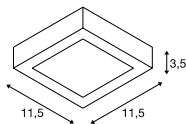

220-240V ~50/60Hz | 200mA
Total wattage: 8.4W
Material: aluminium



Down 460lm | 3000K

Options	Prod. no.
<input type="radio"/> white	1003017

SENSER 18
CW, square, PHASE

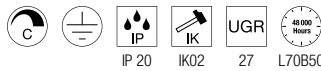
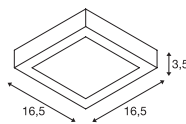

220-240V ~50/60Hz | 350mA
Total wattage: 13W
Material: aluminium



Down 840lm | 3000K

Options	Prod. no.
<input type="radio"/> white	1003018

SENSER 24
CW, square, PHASE

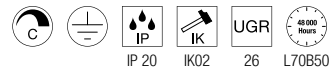
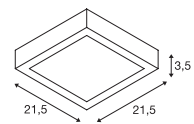

220-240V ~50/60Hz | 500mA
Total wattage: 15W
Material: aluminium



Down 1140lm | 3000K
1240lm | 4000K

Options	Prod. no.
<input type="radio"/> white	1003019
1140lm 3000K	
<input type="radio"/> white	1004705
1240lm 4000K	





SENSER 12
CW, round, PHASE

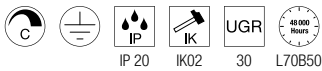
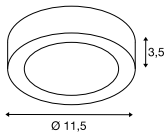

220-240V ~50/60Hz | 200mA
Total wattage: 8.4W
Material: aluminium



Down 460lm | 3000K
470lm | 4000K

Options	Prod. no.
○ white 460lm 3000K 8.4W	1003014
○ white 470lm 4000K 8.2W	1004700

SENSER 18
CW, round, PHASE

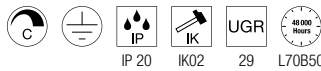
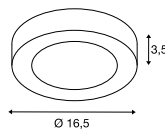

220-240V ~50/60Hz | 350mA
Total wattage: 13W
Material: aluminium



Down 830lm | 3000K
990lm | 4000K

Options	Prod. no.
○ white 830lm 3000K 13W	1003015
○ white 990lm 4000K 12W	1004701

SENSER 24
CW, round, PHASE

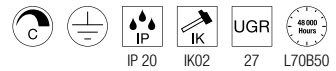
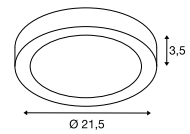

220-240V ~50/60Hz | 500mA
Total wattage: 15W
Material: aluminium



Down 1140lm | 3000K
1300lm | 4000K

Options	Prod. no.
○ white 1140lm 3000K	1003016
○ white 1300lm 4000K	1004702

SIMA
CW, round, Sensor

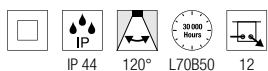
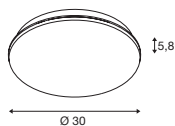

220-240V ~50/60Hz | 320mA
Total wattage: 24W
Material: polycarbonate (PC)



Down 2200lm | 3000K

Options	Prod. no.
<input type="radio"/> white	1005086

SIMA
CW, round, PHASE

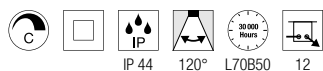
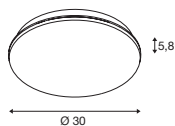

220-240V ~50/60Hz | 320mA
Total wattage: 24W
Material: polycarbonate (PC)



Down 2200lm | 3000K

Options	Prod. no.
<input type="radio"/> white	1005085

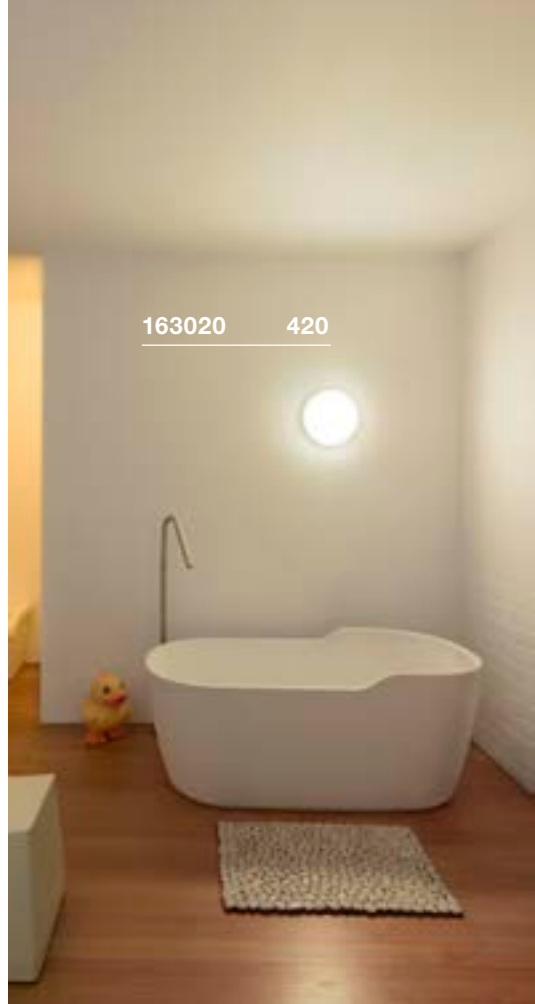

163020 420

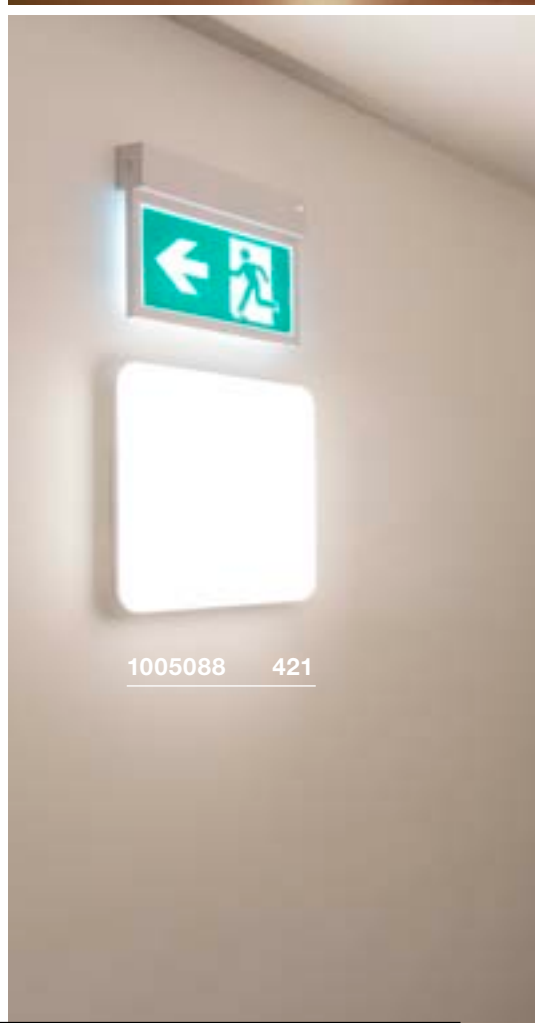

1005088 421



1005087 421

SIMA
CW, square, Sensor

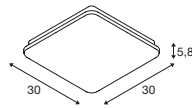

SIMA
CW, square, PHASE

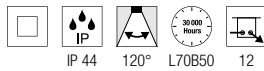
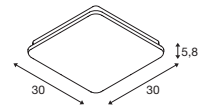

220-240V ~50/60Hz | 320mA
Total wattage: 24W
Material: polycarbonate (PC)



Down 2200lm | 3000K

Options	Prod. no.
<input type="radio"/> white	1005088

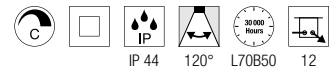

220-240V ~50/60Hz | 320mA
Total wattage: 24W
Material: polycarbonate (PC)



Down 2200lm | 3000K

Options	Prod. no.
<input type="radio"/> white	1005087



1002021 423





LIPSY® 30
CW, Dome

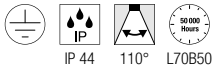
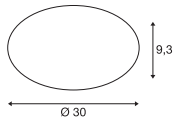
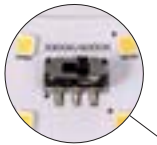

220-240V ~50/60Hz | 350mA
Total wattage: 13.5W
Material: aluminium/polycarbonate (PC)



Down 1550lm | 3000K | 1600lm | 4000K

Options	Prod. no.
<input type="radio"/> white	1002020

LIPSY® 40
CW, Dome

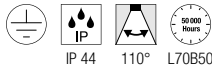
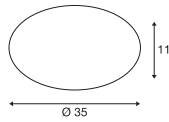
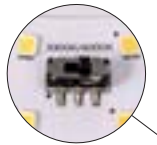

220-240V ~50/60Hz | 500mA
Total wattage: 17.5W
Material: aluminium/polycarbonate (PC)



Down 2050lm | 3000K | 2200lm | 4000K

Options	Prod. no.
<input type="radio"/> white	1002021

LIPSY® 50
CW, Dome

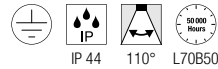
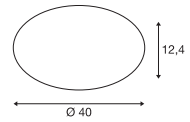
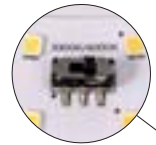

220-240V ~50/60Hz | 500mA
Total wattage: 20W
Material: aluminium/polycarbonate (PC)



Down 2500lm | 3000K | 2700lm | 4000K

Options	Prod. no.
<input type="radio"/> white	1002022

1002076 425





LIPSY® 30
CW, Drum

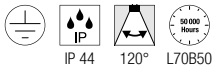
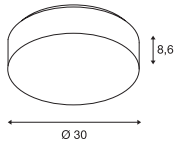
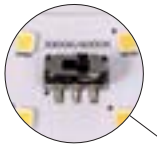

220-240V ~50/60Hz | 350mA
Total wattage: 13.5W
Material: aluminium/polycarbonate (PC)



Down 1600lm | 3000K | 1650lm | 4000K

Options	Prod. no.
<input type="radio"/> white	1002075

LIPSY® 40
CW, Drum

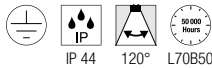
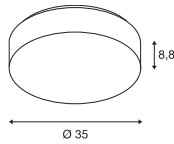
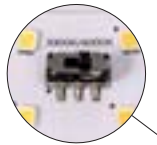

220-240V ~50/60Hz | 500mA
Total wattage: 17.5W
Material: aluminium/polycarbonate (PC)



Down 2100lm | 3000K | 2300lm | 4000K

Options	Prod. no.
<input type="radio"/> white	1002076

LIPSY® 50
CW, Drum

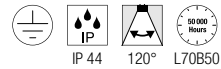
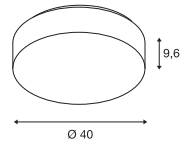
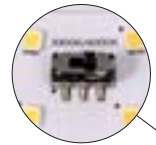

220-240V ~50/60Hz | 500mA
Total wattage: 20W
Material: aluminium/polycarbonate (PC)



Down 2450lm | 3000K | 2600lm | 4000K

Options	Prod. no.
<input type="radio"/> white	1002077



1002940 426

LIPSY® 40
CW, Drum, DALI

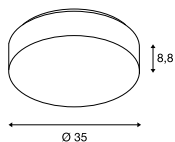
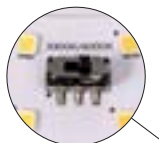

LIPSY® 50
CW, Drum, DALI

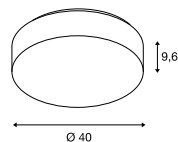
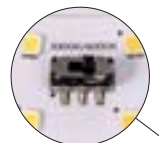

1002941 426

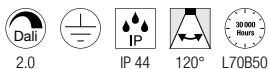

220-240V ~50/60Hz | 500mA
Total wattage: 18W
Material: aluminium/polycarbonate (PC)



Down 2100lm | 3000K | 2300lm | 4000K

Options	Prod. no.
<input type="radio"/> white	1002940

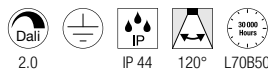

220-240V ~50/60Hz | 500mA
Total wattage: 21W
Material: aluminium/polycarbonate (PC)



Down 2450lm | 3000K | 2600lm | 4000K

Options	Prod. no.
<input type="radio"/> white	1002941



155236 427

MELAN
CW, E27



GLASSA
CW, square, E27

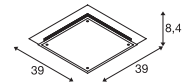
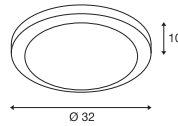

155180 427

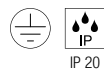

220-240V ~50/60Hz
Material: aluminium/glass



220-240V ~50/60Hz
Material: steel/glass



Base: 1xE27 Max. Ø: 7 cm L: 16 cm



Base: 2xE27 Max. Ø: 4.8 cm L: 14.8 cm

Options	Prod. no.
<input checked="" type="radio"/> aluminium	155236

Options	Prod. no.
<input type="radio"/> transparent/ chrome	155180



A60 | 7.5W | 320°
2700K | 800lm | EEK=F
8kWh/1000h



Prod. no.: 1005303



LED E27 | 8W | 240°
4000K | 920lm | EEK=E
8kWh/1000h



Prod. no.: 1005290

1006124 429





BATTEN 60 CW

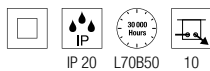
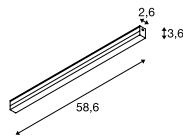

220-240V ~50/60Hz | 110mA
Total wattage: 9W
Material: polycarbonate (PC)

- Switch on light housing
- Feed-in not included



Down 940lm | 3000K | 980lm | 4000K

Options	Prod. no.
<input type="radio"/> white	1006123



Product	Prod. no.
Direct connector	
<input type="radio"/> white	1006128
Feed-in	
<input type="radio"/> white	1006125
Mounting brackets	
<input type="radio"/> white	1006126
60 cm cable connector	
<input type="radio"/> white	1006127

BATTEN 120 CW

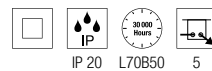
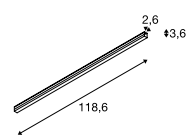

220-240V ~50/60Hz | 220mA
Total wattage: 18W
Material: polycarbonate (PC)

- Switch on light housing
- Feed-in not included



Down 1900lm | 3000K | 1960lm | 4000K

Options	Prod. no.
<input type="radio"/> white	1006124



Product	Prod. no.
Direct connector	
<input type="radio"/> white	1006128
Feed-in	
<input type="radio"/> white	1006125
Mounting brackets	
<input type="radio"/> white	1006126
60 cm cable connector	
<input type="radio"/> white	1006127

LONG GRILL
CW

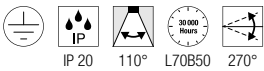
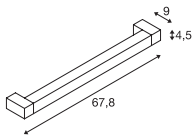

220-240V ~50/60Hz | 700mA
Total wattage: 20W
Material: aluminium/acrylic



Down 1600lm | 3000K

Options	Prod. no.
● black	1001020
○ white	1001019

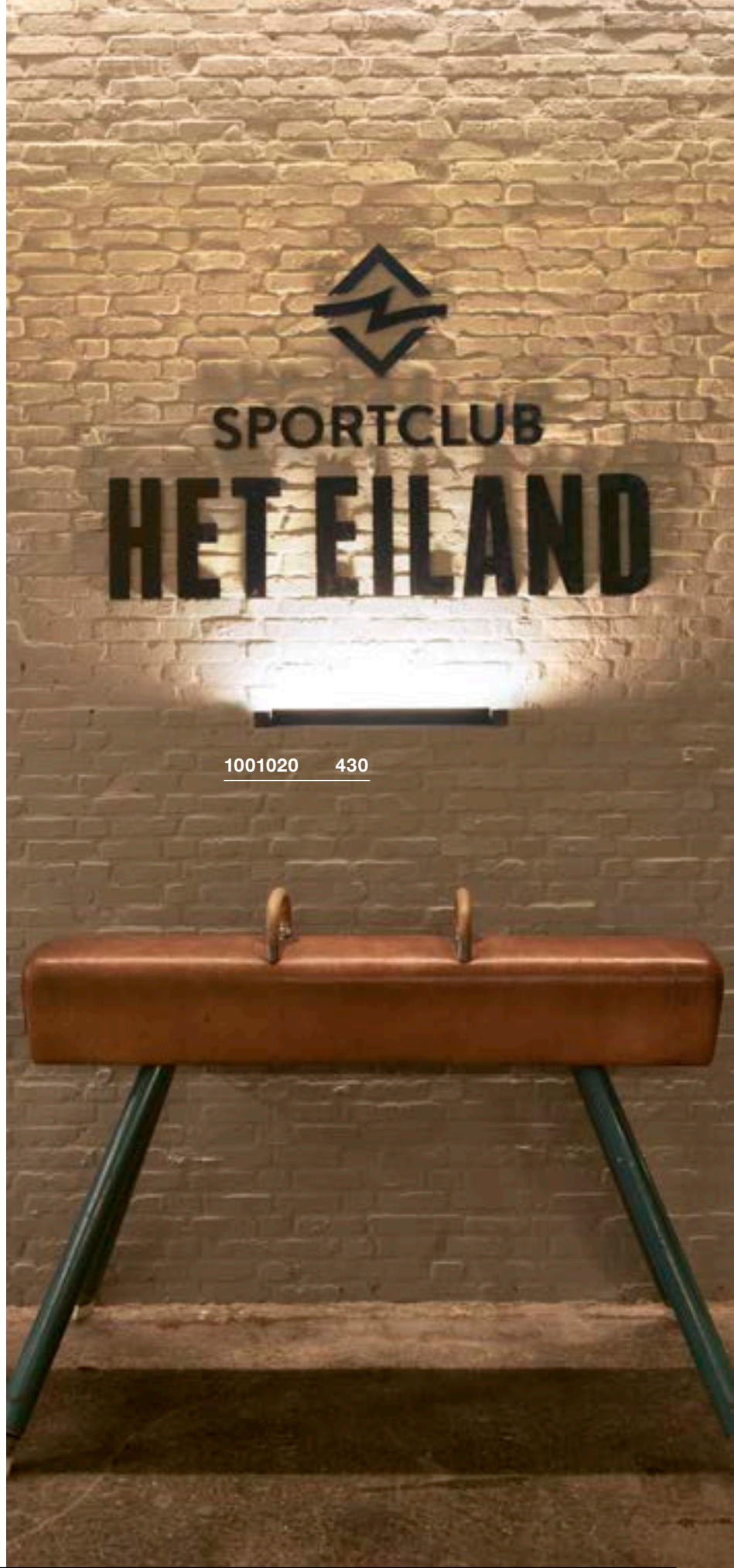

1001020 430



SIGHT 60
CW

SIGHT 115
CW

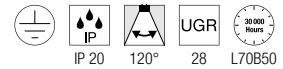
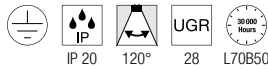
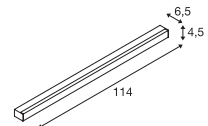
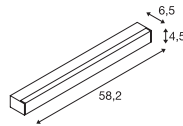
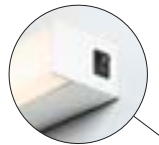

220-240V ~50/60Hz | 700mA
Total wattage: 20W
Material: aluminium/acrylic

220-240V ~50/60Hz | 700mA
Total wattage: 38W
Material: aluminium/acrylic

- Switch on light housing



Down 1490lm | 3000K

Down 3100lm | 3000K

Options	Prod. no.
● black	1001283
○ white	1001284

Options	Prod. no.
● black	1001286
○ white	1001287

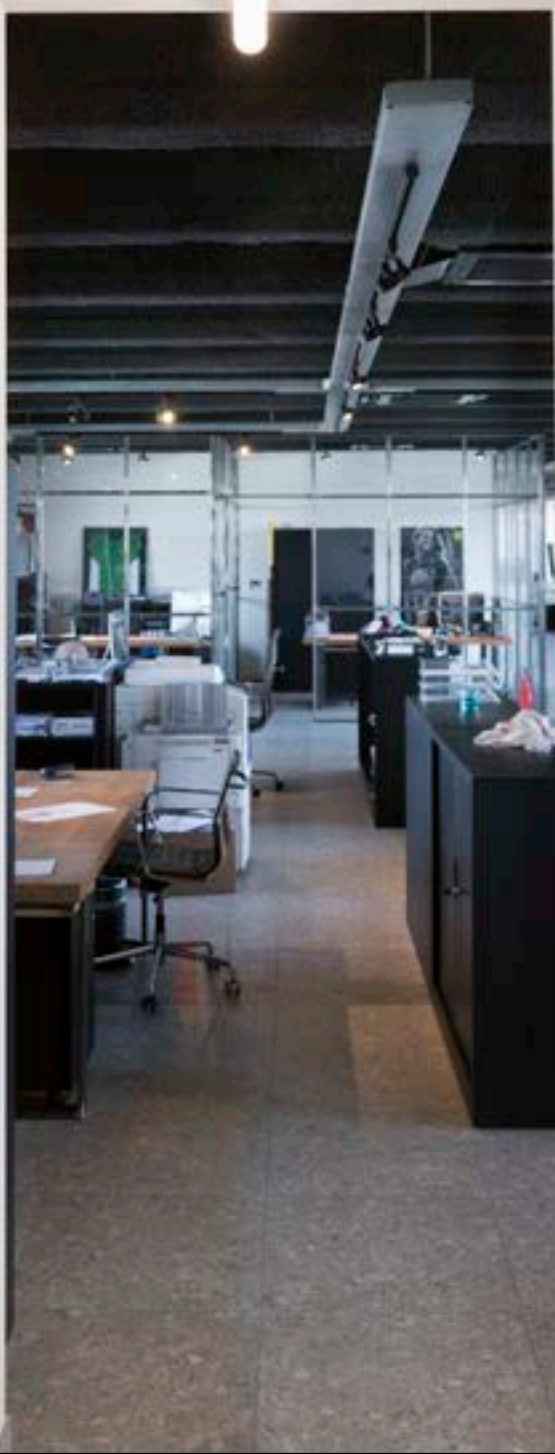



631337 433



BENA 120
CW

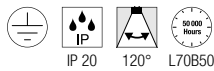
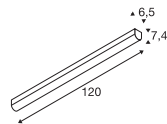

220-240V ~50/60Hz | 700mA
Total wattage: 28W
Material: poly (methyl methacrylate)
(PMMA)/steel



Down 3800lm | 3000K

Options	Prod. no.
<input type="radio"/> white	631337

BENA 150
CW

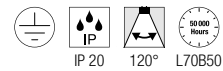
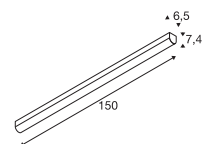

220-240V ~50/60Hz | 700mA
Total wattage: 36W
Material: poly (methyl methacrylate)
(PMMA)/steel



Down 5000lm | 3000K

Options	Prod. no.
<input type="radio"/> white	631339



1007697 439





NEW

ONE®
can be found
on family pages
196-197

LED



NEW

LED

VINOLINA ONE | 437



NEW

LED

VINOLINA | 437



NEW

LED

VINOLINA TWO | 439



NEW

LED

TAHA | 441



NEW

SCKET

TINY SUN | 443



NEW

SCKET

LITTLE SUN | 443



NEW

SCKET

VARYT | 443



NEW

LED

WORKLIGHT PRO | 444



NEW

LED

WORKLIGHT PRO | 444



LED

WORKLIGHT | 445



LED

WORKLIGHT | 445



SCKET

FENDA | 447



SCKET

FENDA | 447



SCKET

FENDA | 447



SCKET

FENDA | 448



SCKET

FENDA BOW BASIS | 448



FENDA | 448



FENDA | 449



FENDA | 449



FENDA | 449



LED

KARPO | 452



LED

KARPO | 452



SCKET

PHELIA | 453



LED

TONILA | 453



LED

MAGANDA | 453



1007357 437

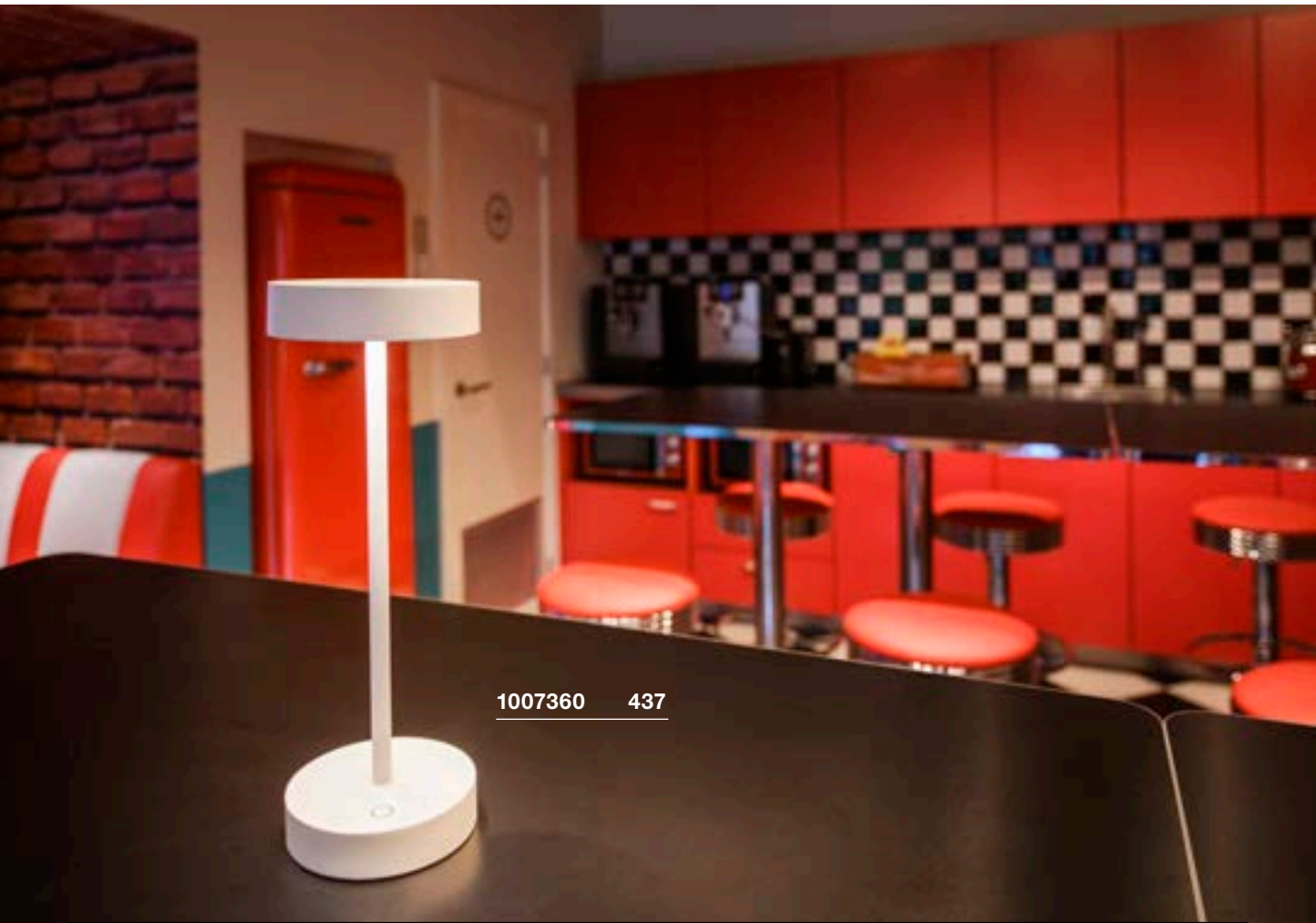

1007360 437



VINOLINA ONE TL, Battery

VINOLINA TL, Battery

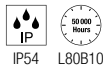
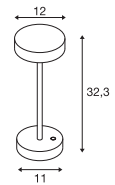
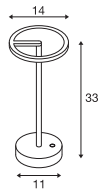
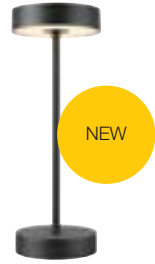
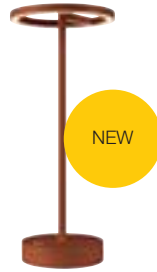

5V battery operation
Total wattage: 2.5W
Material: aluminium

- Running time 12h
- Charging time 7h
- Charging plate included
- Power adapter not included
- USB A

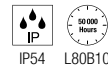

5V battery operation
Total wattage: 2.2W
Material: aluminium

- Running time 12h
- Charging time 7h
- Charging plate included
- Power adapter not included
- USB A



Down 125lm | 2700K



Down 130lm | 2700K | 130lm | 3000K

Options	Prod. no.
● black	1007359 ●
○ white	1007357 ●
● rust	1007358 ●

Options	Prod. no.
● black	1007362 ●
○ white	1007360 ●
● rust	1007361 ●



1007692 439



VINOLINA TWO TL, Battery

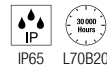
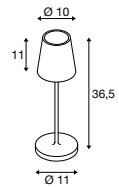

IP65 L70B20

5V battery operation

Total wattage: 2W

Material: aluminium

- Touch dimmable
- Running time 10h
- Charging time 5h
- Charging station for one luminaire included



Down

190lm	2200K
	2700K
	3000K

Options	Prod. no.
● black	1007693 ●
○ white	1007692 ●
● sand	1007697 ●
● rust	1007695 ●
● red	1007694 ●
● lime green	1007696 ●



1007380 441



TAHA

Light set, battery-powered

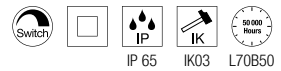
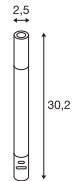

100-240V ~50/60Hz | 5V battery operation
 Total wattage: 5W
 Max. U-out driver: 5V DC
 Material: aluminium/plastic

- Charging cable included



Down

200lm | 2700K

Options	Prod. no.
● black	1007380 ●



1007366 443

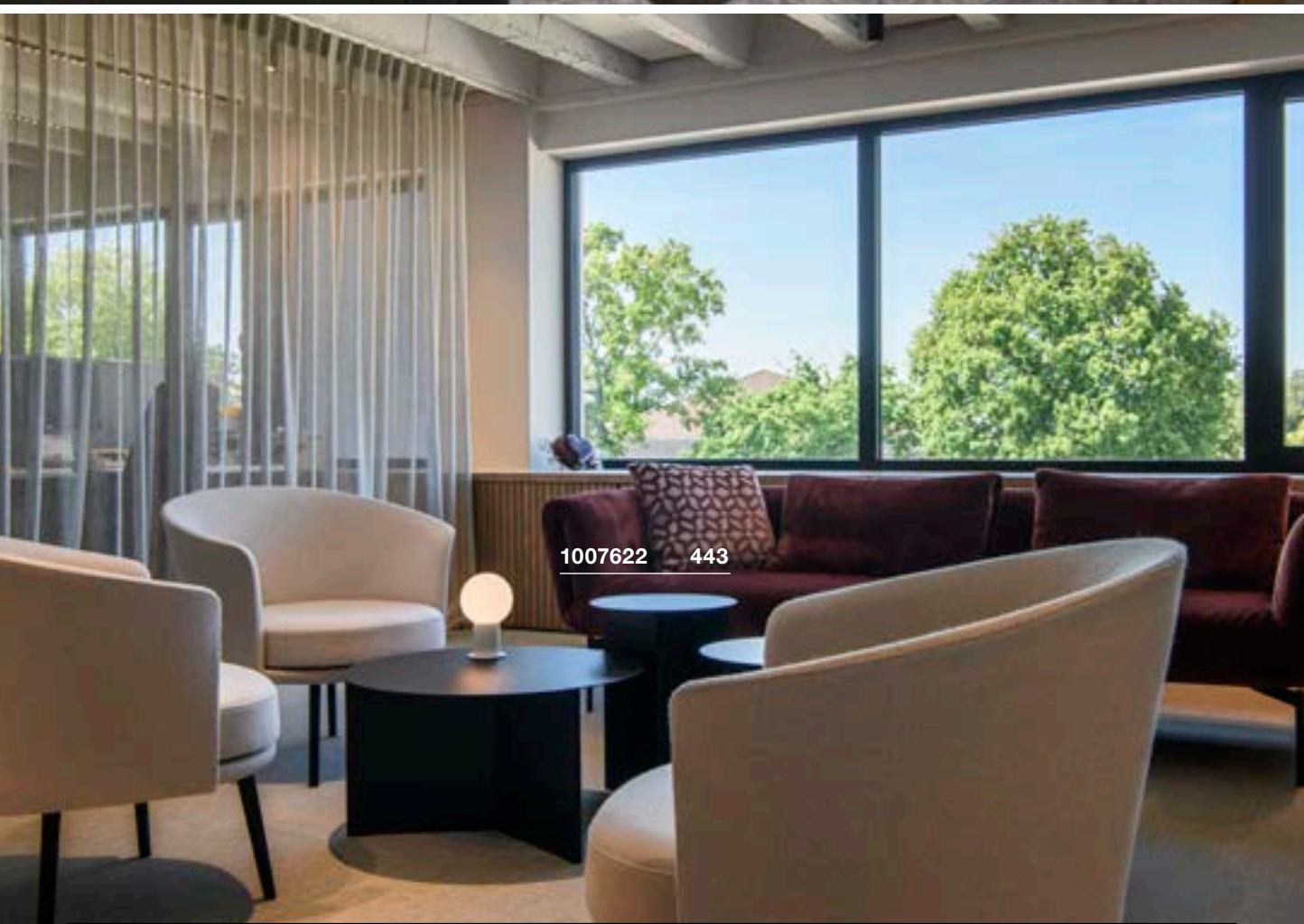

1007622 443



TINY SUN
TL

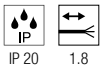
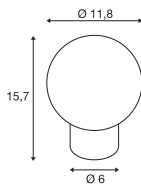

220-240V ~50/60Hz
Material: steel

- Euro plug



Base: 1xG69 Max. diameter: 3 cm L: 6 cm

Options	Prod. no.
● copper	1007364 ●
● bronze	1007363 ●



LED G9 | 3.6W | 300°
3000K | 400lm | EEK=E
4kWh/1000h

Prod. no.: 1005286

LITTLE SUN
TL

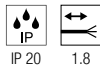
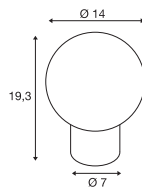

220-240V ~50/60Hz
Material: steel

- Euro plug



Base: 1xG69 Max. diameter: 3 cm L: 6 cm

Options	Prod. no.
● copper	1007366 ●
● bronze	1007365 ●



LED G9 | 3.6W | 300°
3000K | 400lm | EEK=E
4kWh/1000h

Prod. no.: 1005286

VARYT
TL, E14

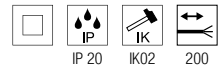
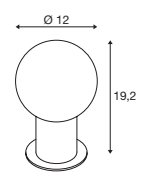

220-240V ~50/60Hz
Material: aluminium/steel

- Euro plug



Base: 1xE14 Max. diameter: 3.8 cm L: 11 cm

Options	Prod. no.
● black	1007620 ●
○ white	1007622 ●
● brass	1007623 ●
● chrome	1007621 ●



C35 | 4.2W | 320°
2700K | 350lm | EEK=G
5kWh/1000h

Prod. no.: 1005285



WORKLIGHT PRO
FL, single

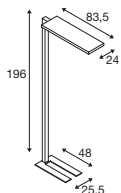
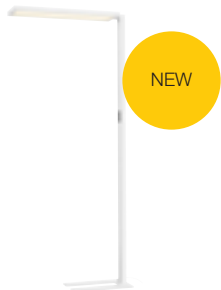

IP 20
 IK 03
 75°
 115°
 UGR 14
 L80B10
 50000 hours

200-240V ~50/60Hz | 48V
Total wattage: 100W
Material: aluminium/steel

- Safety plug
- Touch dimmable



Up 10700lm | 4000K
Down 2300lm

Options	Prod. no.
● black	1007462
○ white	1007463
● grey	1007464

WORKLIGHT PRO
FL, double

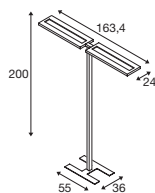
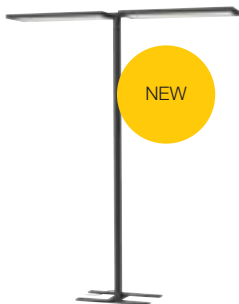

IP 20
 IK 03
 75°
 115°
 UGR 16
 L80B10
 50000 hours

200-240V ~50/60Hz | 48V
Total wattage: 150W
Material: aluminium/steel

- Safety plug
- Touch dimmable



Up 15600lm | 4000K
Down 4400lm

Options	Prod. no.
● black	1007465
○ white	1007466
● grey	1007467





1006344 445

WORKLIGHT TL

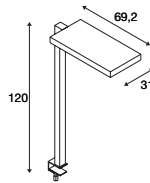

IP 20 IK02 80° 110° 19 L80B10

250

200-240V ~50/60Hz | 2000mA
 Total wattage: 79W
 Material: aluminium

- Clamping range of 6-40 mm
- Safety plug
 - Touch dimmable



Up 3800lm | 4000K
 Down 3800lm

Options	Prod. no.
● black	1005392
○ white	1005394
○ silver	1006344 ●



1005391 445

WORKLIGHT FL

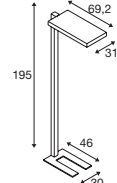

IP 20 IK02 80° 110° 19 L80B10

250

200-240V ~50/60Hz | 2000mA
 Total wattage: 79W
 Material: aluminium

- Safety plug
- Touch dimmable



Up 3800lm | 4000K
 Down 3800lm

Options	Prod. no.
● black	1005390
○ white	1005391
○ silver	1006343 ●



132660 + 1000580 296 + 449

155790 + 155592 447 + 449

155780 + 155592 447 + 449

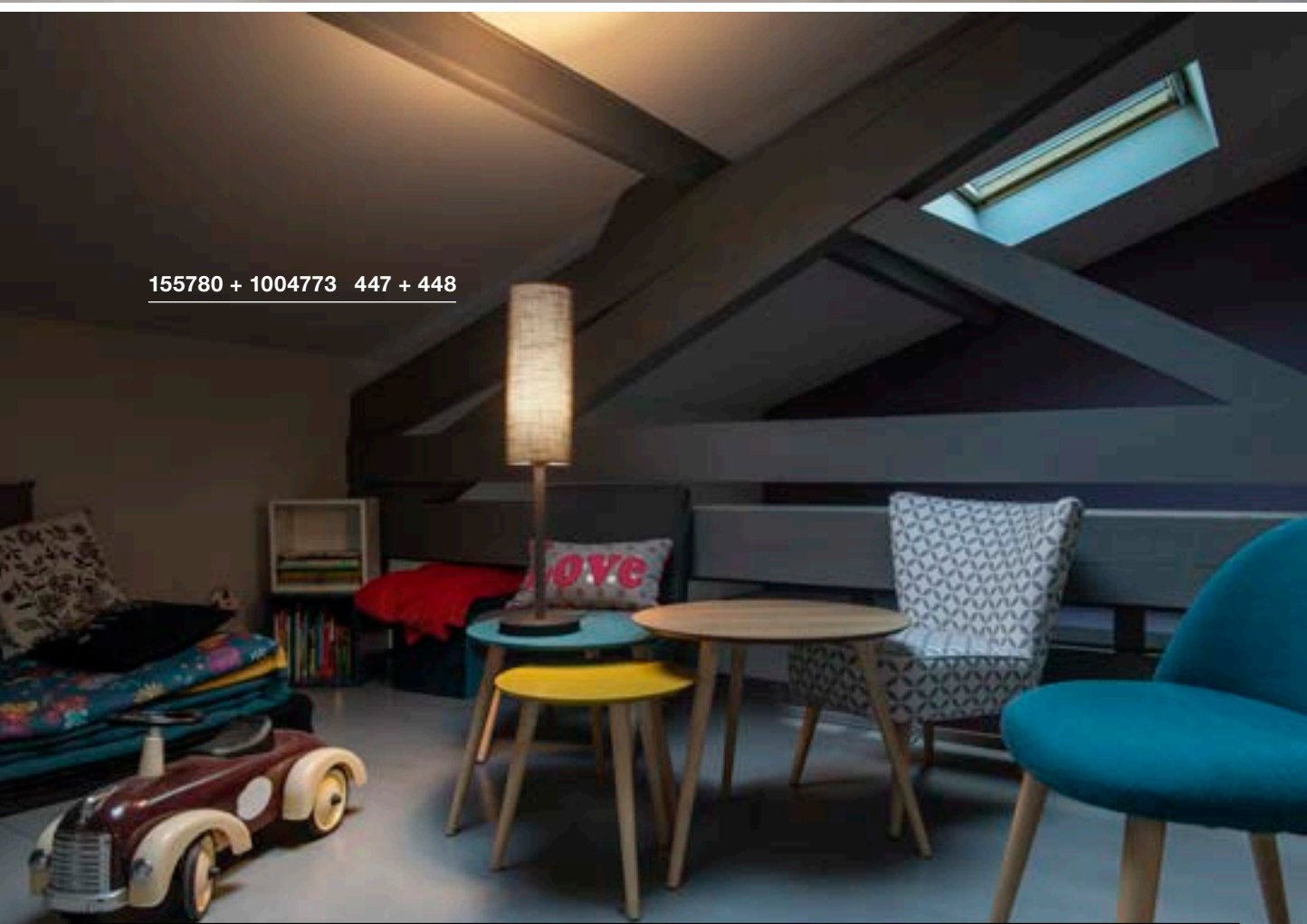

155780 + 1004773 447 + 448



FENDA TL, E27

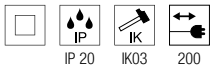
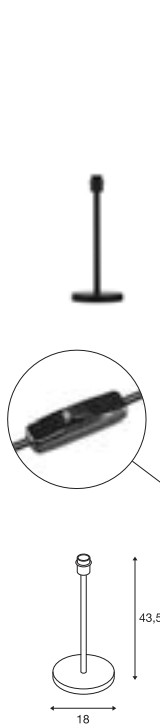

220-240V ~50/60Hz
Material: steel

- Euro plug and switch



Base: 1xE27

Options	Prod. no.
● black	155780

A60 | 7.5W | 320°
 2700K | 800lm | EEK=F
 8kWh/1000h

Prod. no.: 1005303

FENDA FL, E27

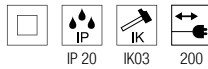

220-240V ~50/60Hz
Material: steel/plastic

- Euro plug and switch



Base: 1xE27

Options	Prod. no.
● black	155790

LED E27 | 13.2W | 220°
 2700K | 1300lm | EEK=F
 13kWh/1000h

Prod. no.: 1005302

FENDA TL, E27

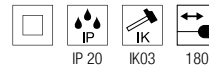
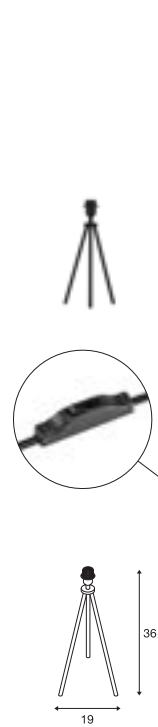

220-240V ~50/60Hz
Material: aluminium/plastic

- Euro plug and switch



Base: 1xE27

Options	Prod. no.
● black	155540

LED E27 | 7.5W | 320°
 2500K | 700lm | EEK=F
 8kWh/1000h

Prod. no.: 1005265

FENDA
FL, E27

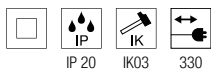
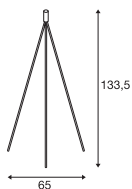

220-240V ~50/60Hz
Material: aluminium

- Switch on light body
- Euro plug

SOCKET INSIDE <40 W

Base: 1xE27

Options	Prod. no.
● black	155490



LED E27 | 13.2W | 220°
2700K | 1300lm | EEK=F
13kWh/1000h

Prod. no.: 1005302



FENDA BOW BASIS
FL, E27

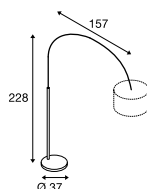

220-240V ~50/60Hz
Material: steel

- max. shade weight 900g
- Euro plug and switch

SOCKET INSIDE <25 W

Base: 1xE27

max. L: 17.5 cm

Options	Prod. no.
● black	1003029
● chrome	1000763



A60 | 7.5W | 320°
2700K | 800lm | EEK=F
8kWh/1000h

Prod. no.: 1005303



FENDA
15 cm, Round



H: 40 cm
Diameter: 15 cm
Material: textile/steel

Options	Prod. no.
● black/copper	156152
○ white	156141
● grey	1004773
● beige	156143



155490 + 1004773 448 + 449



FENDA
30 cm, Round



H: 20 cm
Diameter: 30 cm
Material: textile/steel

Options	Prod. no.
● black/copper	155592
○ white	155582
● grey	1004774
● beige	155583

FENDA
Ø 45 cm, Round



H: 28 cm
Diameter: 45.5 cm
Material: textile/steel

Options	Prod. no.
● black/copper	156122
○ white	156111
● grey	1004775
● beige	156113

FENDA
Ø 70 cm, Round



H: 36 cm
Diameter: 70 cm
Material: textile/steel

- Not suitable for Fenda Bow.

Options	Prod. no.
● black/copper	1000580
○ white	1000579



1003032 448

MIX & MATCH FENDA

FENDA Ø15

Black	156152
White	156141
Beige	156143
Grey	1004773



FENDA Ø30

Black	155592
White	155582
Beige	155583
Grey	1004774



FENDA Ø45

Black	156122
White	156111
Beige	156113
Grey	1004775

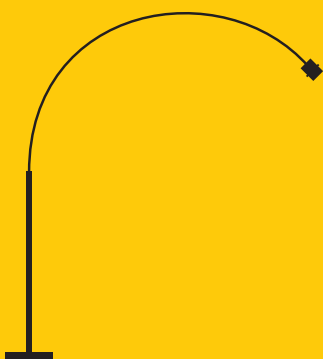

FENDA BOW

Black	1003029
Chrome	1000763



FENDA TL

Black	155780
-------	--------



FENDA FL

Black	155790
-------	--------



FENDA TL

Black	155540
-------	--------



FENDA FL

Black	155490
-------	--------

Combine the SLV Mix & Match products to suit your taste. Designed to work perfectly together, you can mix and match within the FENDA family or even combine the FENDA and FITU product families. You can recognise SLV Mix & Match products by the following symbol:



MIX
match

FENDA Ø70

Black | 1000580
White | 1000579

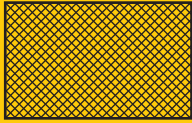

FENDA Ø12,5

Glass Shade

Brown | 1000773

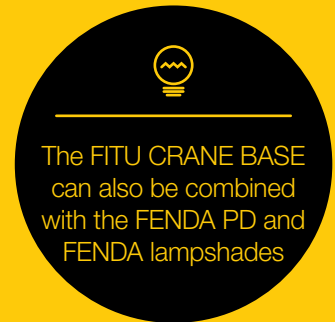

FENDA PD

Black | 132660
White | 132661
Chrome | 132662



FENDA CL

Black | 155550
White | 155551



FITU CRANE BASE

Black | 1004682



FITU PD

Black | 132690
White | 132691

KARPO
TL

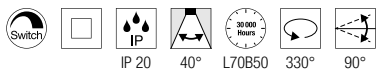
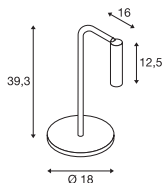

200-240V ~50/60Hz | 500mA
Total wattage: 6.2W
Material: aluminium

- Switch on light body
- Plug-in power supply



Down 360lm | 430lm | 3000K

Options	Prod. no.
● black 360lm	1001461
○ white 430 lm	1001460

KARPO
FL

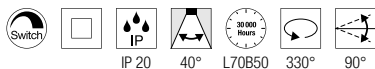
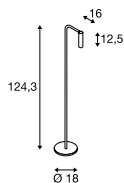

200-240V ~50/60Hz | 500mA
Total wattage: 6.2W
Material: aluminium

- Switch on light body
- Plug-in power supply



Down 360lm | 430lm | 3000K

Options	Prod. no.
● black 360lm	1001463
○ white 430 lm	1001462

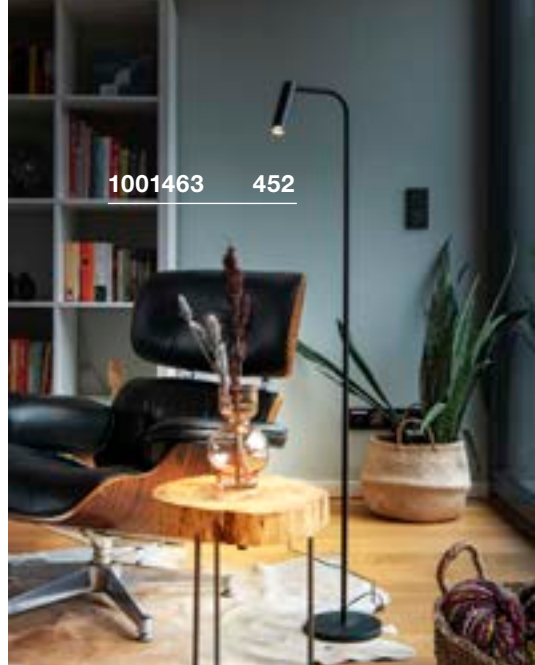

1001463 452

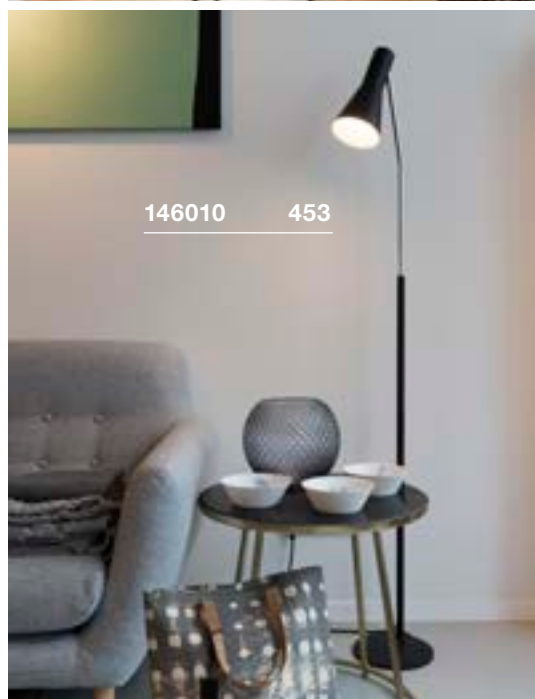

146010 453

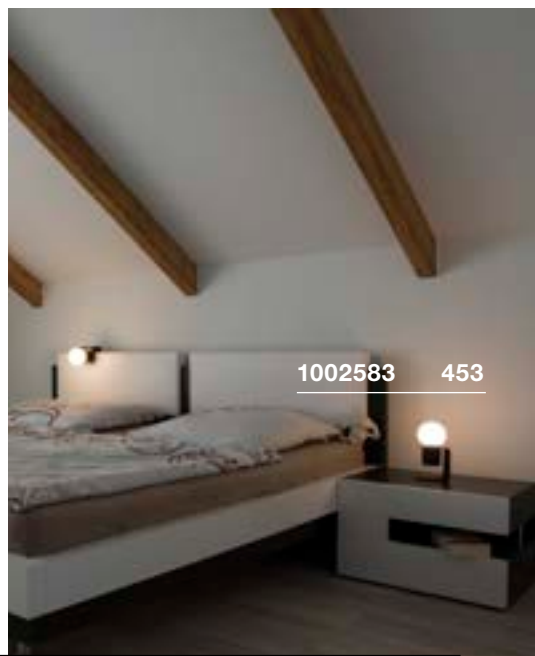

1002583 453



PHELIA
FL, E27

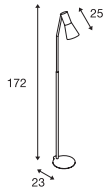

220-240V ~50/60Hz
Material: aluminium/steel

- Switch on light body
- Safety plug and switch



Base: 1xE27 Max. diameter: 5.3 cm L: 18 cm

Options	Prod. no.
● black	146010



A60 | 7.5W | 320°
2700K | 800lm | EEK=F
8kWh/1000h

Prod. no.: 1005303



TONILA
TL

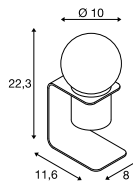

5V battery operation
Total wattage: 1.6W
Material: aluminium/plastic

- Battery 3.6V 2000mAh included
- Power adapter excluding USB charger 5V DC/1-2A required. For MINI-USB charging cable.
- Can be dimmed to 3 different levels using the switch.



Down 90lm | 2700K

Options	Prod. no.
● black	1002583

MAGANDA
TL

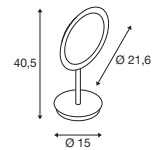

100-240V ~50/60Hz | 12V
Total wattage: 4.8W
Material: steel/glass

- 3 colour temperature options via button
- IP44 safety plug



45lm | 2700K 48lm | 3000K 51lm | 4000K

Options	Prod. no.
● chrome/frosted	1004970

1006672 469

1006623 475

1006834 471





NEW



NUMINOS® XS | 468



NEW



NUMINOS® S | 468



NEW



NUMINOS® XS | 470



NEW



NUMINOS® S | 470



NEW



IN-LINE 22 | 473



NEW



IN-LINE 22 | 473



NEW



IN-LINE 44 | 475



NEW



IN-LINE 44 | 475



NEW



IN-LINE 24 | 477



NEW



IN-LINE 46 | 477

1006623 + 1006617 475 + 473





48V TRACK

DALI mounting track

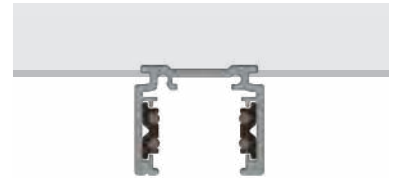

	1 m	1 m	2 m	2 m
Nominal voltage (V)	48V DC	48V DC	48V DC	48V DC
Max. current (A)	16	16	16	16
max. mech. load	5kg	5kg	10kg	10kg
Colour	● black	○ white	● black	○ white
Material	aluminium	aluminium	aluminium	aluminium
L x W x H (cm)	100 x 2.62 x 2.26	100 x 2.62 x 2.26	200 x 2.62 x 2.26	200 x 2.62 x 2.26
Prod. no.	1006541 ●	1006542 ●	1006543 ●	1006544 ●
	3 m	3 m	4 m	4 m
Nominal voltage (V)	48V DC	48V DC	48V DC	48V DC
Max. current (A)	16	16	16	16
max. mech. load	15kg	15kg	20kg	20kg
Colour	● black	○ white	● black	○ white
Material	aluminium	aluminium	aluminium	aluminium
L x W x H (cm)	300 x 2.62 x 2.26	300 x 2.62 x 2.26	400 x 2.62 x 2.26	400 x 2.62 x 2.26
Prod. no.	1006545 ●	1006546 ●	1006547 ●	1006548 ●



48V TRACK

DALI mounting track
Planning assistance and accessories at a glance

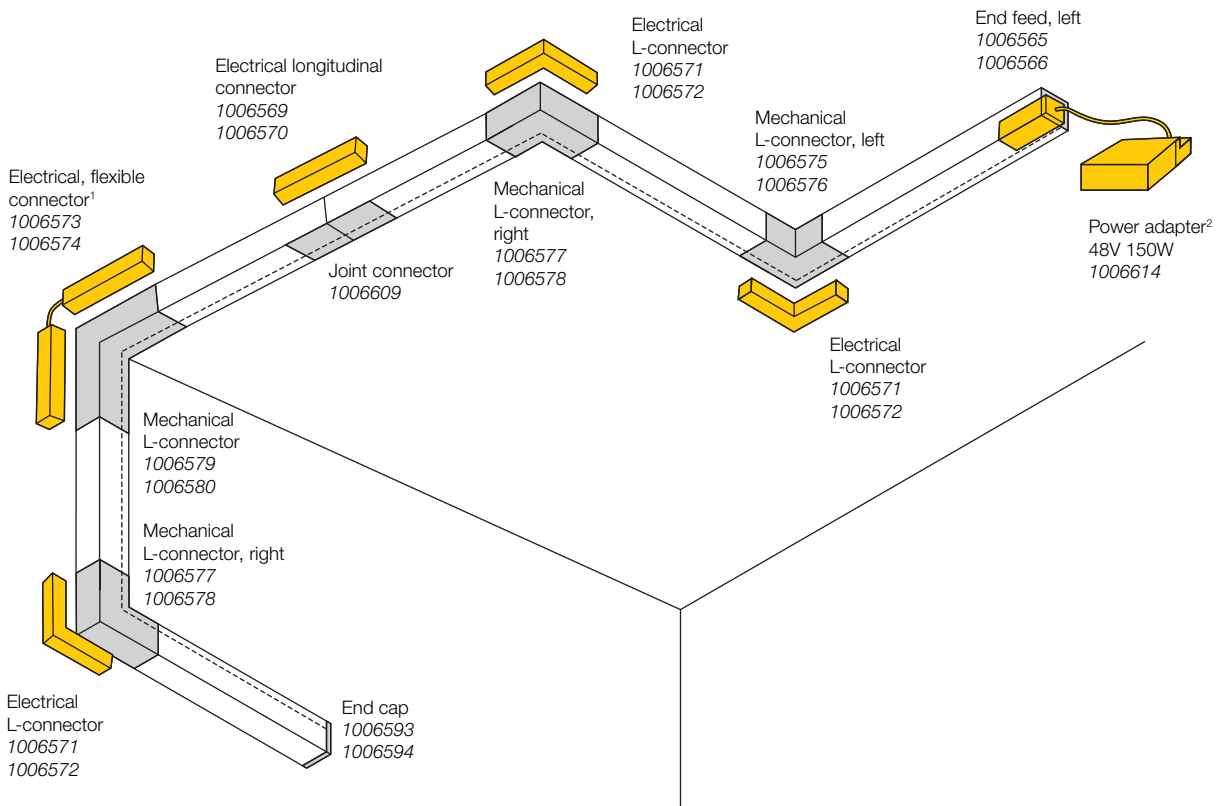

¹ Please note that electrical and mechanical connectors must always be installed together.
² Power adapter must be placed externally.

**End feed, right**16A max. | polycarbonate (PC)
L: 9.7 cm | W: 1.6 cm | H: 1.9 cm

- black Prod. no. **1006567**
- white Prod. no. **1006568**

Power adapter 48V | 60WPolycarbonate (PC)
L: 18 cm | W: 4.5 cm | H: 2.7 cm

- white Prod. no. **1006613**

End feed, left16A max. | polycarbonate (PC)
L: 9.7 cm | W: 1.6 cm | H: 1.9 cm

- black Prod. no. **1006565**
- white Prod. no. **1006566**

Power adapter 150W | 48VMetal/polycarbonate (PC)
L: 19.05 cm | W: 8.8 cm | H: 3.55 cm

- black Prod. no. **1006614**

L-connector mechanical, f. mounting track standard, right (f. ceiling installation)aluminium
L: 7.1 cm | W: 7.1 cm | H: 2.19 cm

- black Prod. no. **1006577**
- white Prod. no. **1006578**

Cover, 20mm f. standard track assembly, 2 mAluminium/polycarbonate (PC)
L: 200 cm | W: 2 cm | H: 0.6 cm

- black Prod. no. **1006611**
- white Prod. no. **1006612**

L-connector mechanical, f. mounting track standard, left (f. ceiling installation)aluminium
L: 7.1 cm | W: 7.1 cm | H: 2.19 cm

- black Prod. no. **1006575**
- white Prod. no. **1006576**

End cap f. mounting track standardPolycarbonate (PC)
L: 2.6 cm | W: 0.2 cm | H: 2.2 cm

- black Prod. no. **1006593**
- white Prod. no. **1006594**

L-connector mechanical, f. mounting track, standard, stereo, (wall/ceiling)aluminium
L: 8.4 cm | W: 2.62 cm | H: 8.4 cm

- black Prod. no. **1006579**
- white Prod. no. **1006580**

Track reinforcement plate f. mounting trackSteel
L: 5 cm | W: 1.32 cm | H: 0.25 cm

- grey Prod. no. **1006609**

Electric L-connector, DALI16A max. | polycarbonate (PC)
L: 11.4 cm | W: 11.4 cm | H: 1.9 cm

- black Prod. no. **1006571**
- white Prod. no. **1006572**

Track reinforcement plate with mounting set, 3m wire ropeSteel
L: 12 cm | W: 2.7 cm

- black Prod. no. **1006603**
- white Prod. no. **1006604**

Electric longitudinal connector, DALI16A max. | polycarbonate (PC)
L: 14.4 cm | W: 1.6 cm | H: 1.9 cm

- black Prod. no. **1006569**
- white Prod. no. **1006570**

Track reinforcement plate with mounting set, 1m rodSteel
L: 12 cm | W: 2.7 cm

- black Prod. no. **1006601**
- white Prod. no. **1006602**

Flexible connector, electrical, DALI16A max. | polycarbonate (PC)
L: 23 cm | W: 1.6 cm | H: 1.9 cm

- black Prod. no. **1006573**
- white Prod. no. **1006574**

Pendant suspension, 1m rodSteel
W: 2.9 cm

- black Prod. no. **1006605**
- white Prod. no. **1006606**

Transformer housing incl. end feed right, DALIPolycarbonate (PC)
L: 23.3 cm | W: 10.1 cm | H: 4.1 cm

- black Prod. no. **1007137**
- white Prod. no. **1007138**

Pendant suspension, 3m wire ropeSteel
W: 2.9 cm

- black Prod. no. **1006607**
- white Prod. no. **1006608**

Transformer housing incl. end feed left, DALIPolycarbonate (PC)
L: 23.3 cm | W: 10.1 cm | H: 4.1 cm

- black Prod. no. **1007083**
- white Prod. no. **1007084**

Mounting bracketaluminium
L: 3 cm | W: 2.72 cm | H: 1.05 cm

- black Prod. no. **1006599**
- white Prod. no. **1006600**

1006726 + 1006623 + 1006617 469 + 475 + 473

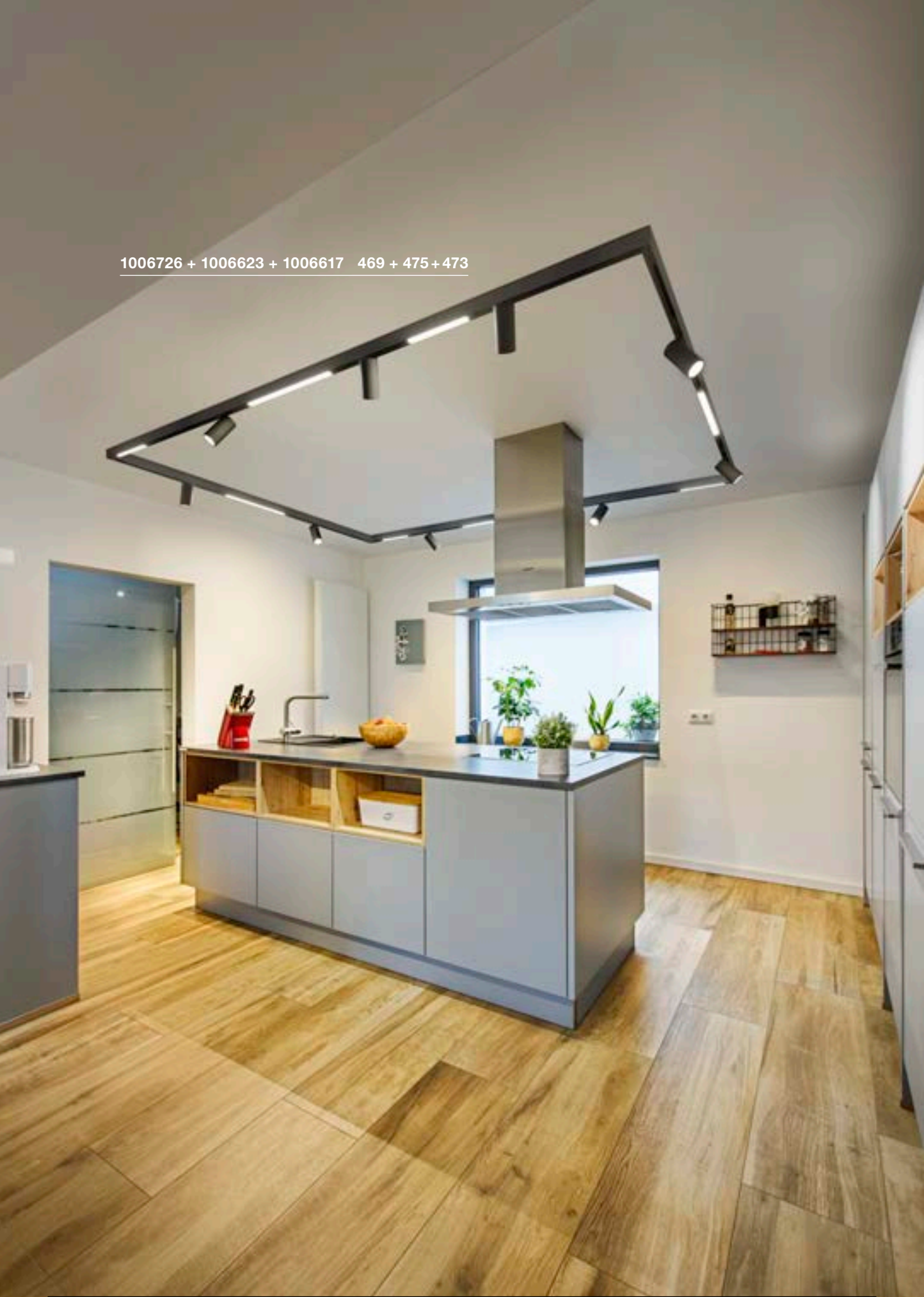



48V TRACK

DALI deep mounting track



	1 m	1 m	2 m	2 m
Nominal voltage (V)	48V DC	48V DC	48V DC	48V DC
Max. current (A)	16	16	16	16
max. mech. load	5kg	5kg	10kg	10kg
Colour	● black	○ white	● black	○ white
Material	aluminium	aluminium	aluminium	aluminium
L x W x H (cm)	100 x 2.62 x 4.72	100 x 2.62 x 4.72	200 x 2.62 x 4.72	200 x 2.62 x 4.72
Prod. no.	1006549 ●	1006550 ●	1006551 ●	1006552 ●

	3 m	3 m	4 m	4 m
Nominal voltage (V)	48V DC	48V DC	48V DC	48V DC
Max. current (A)	16	16	16	16
max. mech. load	15kg	15kg	20kg	20kg
Colour	● black	○ white	● black	○ white
Material	aluminium	aluminium	aluminium	aluminium
L x W x H (cm)	300 x 2.62 x 4.72	300 x 2.62 x 4.72	400 x 2.62 x 4.72	400 x 2.62 x 4.72
Prod. no.	1006553 ●	1006554 ●	1006555 ●	1006556 ●



48V TRACK

DALI deep mounting track
Planning assistance and accessories at a glance

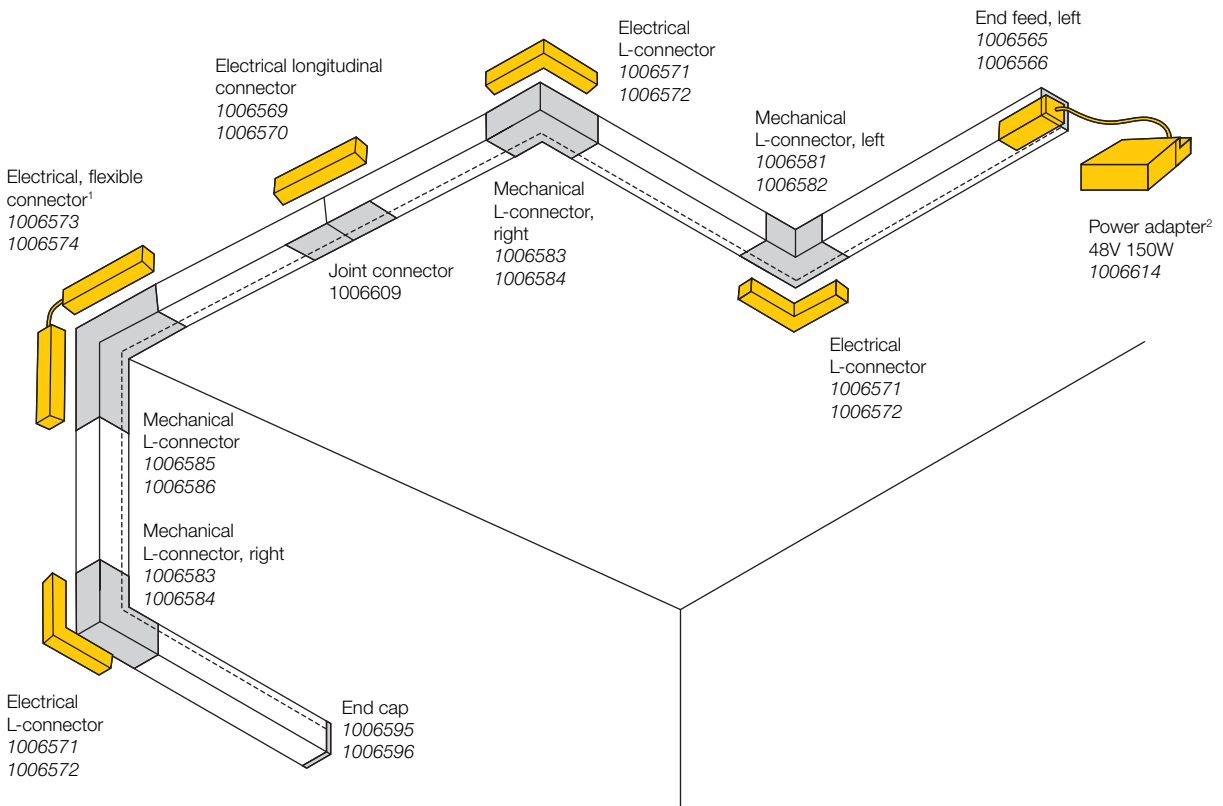

¹ Please note that electrical and mechanical connectors must always be installed together.
² Power adapter must be placed externally.

**End feed, right**16A max. | polycarbonate (PC)
L: 9.7 cm | W: 1.6 cm | H: 1.9 cm

- black
- white

Prod. no. **1006567**
1006568**Power adapter 48V | 60W**Polycarbonate (PC)
L: 18 cm | W: 4.5 cm | H: 2.7 cm

- white

Prod. no. **1006613****End feed, left**16A max. | polycarbonate (PC)
L: 9.7 cm | W: 1.6 cm | H: 1.9 cm

- black
- white

Prod. no. **1006565**
1006566**Power adapter 150W | 48V**Metal/polycarbonate (PC)
L: 19.05 cm | W: 8.8 cm | H: 3.55 cm

- black

Prod. no. **1006614****L-connector mechanical f. mounting track deep, right (f. ceiling installation)**aluminium
L: 7.1 cm | W: 7.1 cm | H: 4.7 cm

- black
- white

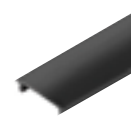
Prod. no. **1006583**
1006584**Track cover, 26mm, f. mounting track deep and recessed track, 2 m**Polycarbonate (PC)
L: 200 cm | W: 26 cm | H: 6 cm

- black
- white

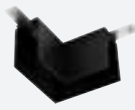
Prod. no. **1007188**
1007189**L-connector mechanical f. mounting track deep, left (f. ceiling installation)**aluminium
L: 7.1 cm | W: 7.1 cm | H: 4.7 cm

- black
- white

Prod. no. **1006581**
1006582**End cap f. mounting track deep**Polycarbonate (PC)
L: 2.6 cm | W: 0.2 cm | H: 4.7 cm

- black
- white

Prod. no. **1006595**
1006596**L-connector mechanical, f. mounting track, deep, stereo (wall/ceiling)**aluminium
L: 8.4 cm | W: 8.4 cm | H: 4.7 cm

- black
- white

Prod. no. **1006585**
1006586**Track reinforcement plate f. mounting track**Steel
L: 5 cm | W: 1.32 cm | H: 0.25 cm

- grey

Prod. no. **1006609****Electric L-connector, DALI**16A max. | polycarbonate (PC)
L: 11.4 cm | W: 11.4 cm | H: 1.9 cm

- black
- white

Prod. no. **1006571**
1006572**Track reinforcement plate with mounting set, 3m wire rope**Steel
L: 12 cm | W: 2.7 cm

- black
- white

Prod. no. **1006603**
1006604**Electric longitudinal connector, DALI**16A max. | polycarbonate (PC)
L: 14.4 cm | W: 1.6 cm | H: 1.9 cm

- black
- white

Prod. no. **1006569**
1006570**Track reinforcement plate with mounting set, 1m rod**Steel
L: 12 cm | W: 2.7 cm

- black
- white

Prod. no. **1006601**
1006602**Flexible connector, electrical, DALI**16A max. | polycarbonate (PC)
L: 23 cm | W: 1.6 cm | H: 1.9 cm

- black
- white

Prod. no. **1006573**
1006574**Pendant suspension, 1m rod**Steel
W: 2.9 cm

- black
- white

Prod. no. **1006605**
1006606**Transformer housing incl. end feed right, DALI**Polycarbonate (PC)
L: 23.3 cm | W: 10.1 cm | H: 4.1 cm

- black
- white

Prod. no. **1007137**
1007138**Pendant suspension, 3m wire rope**Steel
W: 2.9 cm

- black
- white

Prod. no. **1006607**
1006608**Transformer housing incl. end feed left, DALI**Polycarbonate (PC)
L: 23.3 cm | W: 10.1 cm | H: 4.1 cm

- black
- white

Prod. no. **1007083**
1007084**Mounting bracket**aluminium
L: 3 cm | W: 2.72 cm | H: 1.05 cm

- black
- white

Prod. no. **1006599**
1006600

1006783 + 1006672 + 1006635 471 + 471 + 475

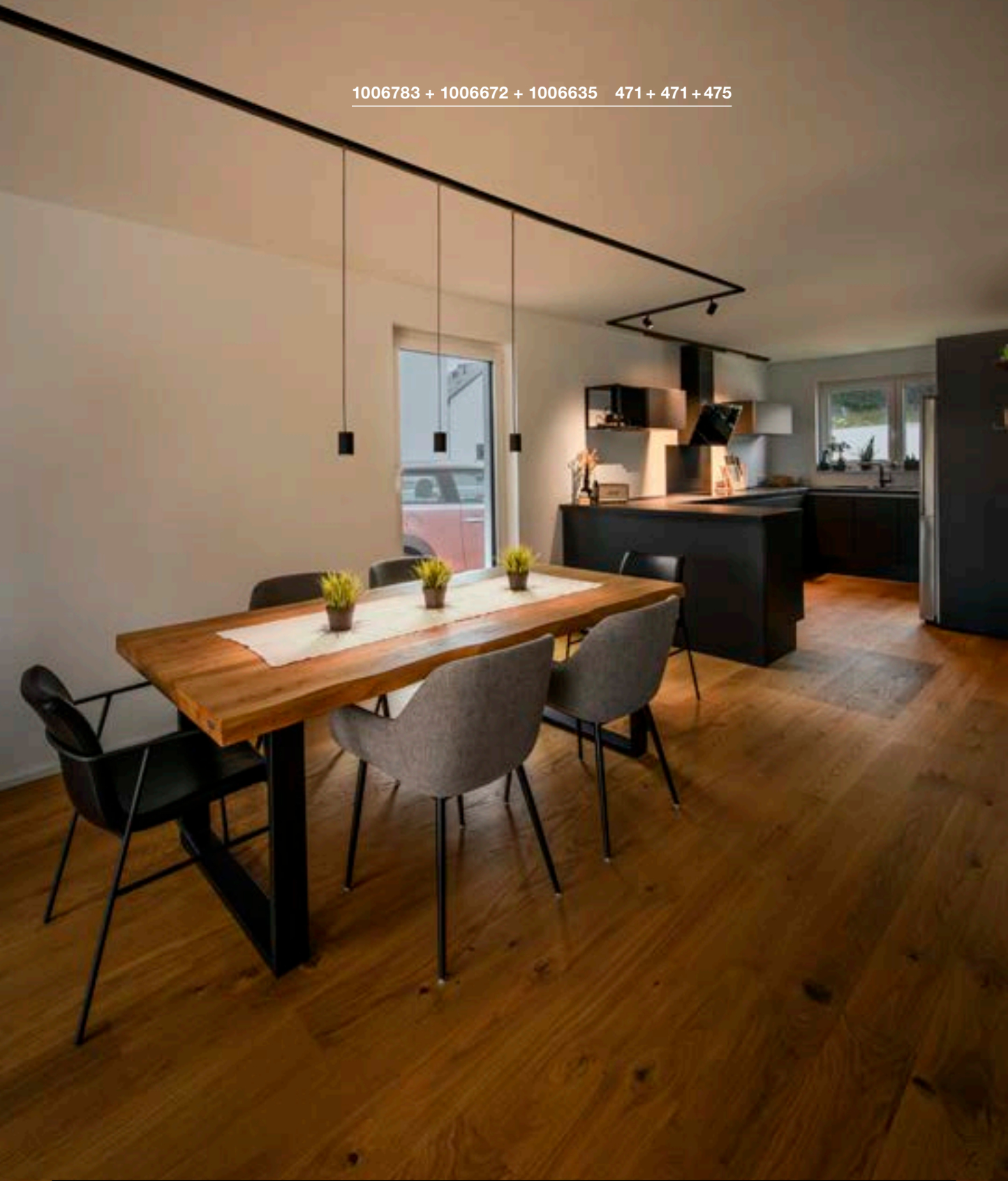



48V TRACK

DALI recessed track

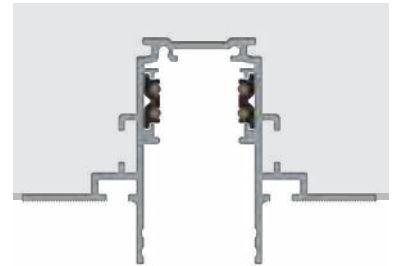

	1 m	1 m	2 m	2 m
Nominal voltage (V)	48V DC	48V DC	48V DC	48V DC
Max. current (A)	16	16	16	16
max. mech. load	5kg	5kg	10kg	10kg
Colour	● black	○ white	● black	○ white
Material	aluminium	aluminium	aluminium	aluminium
L x W x H (cm)	100 x 7.4 x 4.7	100 x 7.4 x 4.7	200 x 7.4 x 4.7	200 x 7.4 x 4.7
Prod. no.	1006557 ●	1006558 ●	1006559 ●	1006560 ●

	3 m	3 m	4 m	4 m
Nominal voltage (V)	48V DC	48V DC	48V DC	48V DC
Max. current (A)	16	16	16	16
max. mech. load	15kg	15kg	20kg	20kg
Colour	● black	○ white	● black	○ white
Material	aluminium	aluminium	aluminium	aluminium
L x W x H (cm)	300 x 7.4 x 4.7	300 x 7.4 x 4.7	400 x 7.4 x 4.7	400 x 7.4 x 4.7
Prod. no.	1006561 ●	1006562 ●	1006563 ●	1006564 ●



NEW

48V TRACK

DALI recessed track
Planning assistance and accessories at a glance

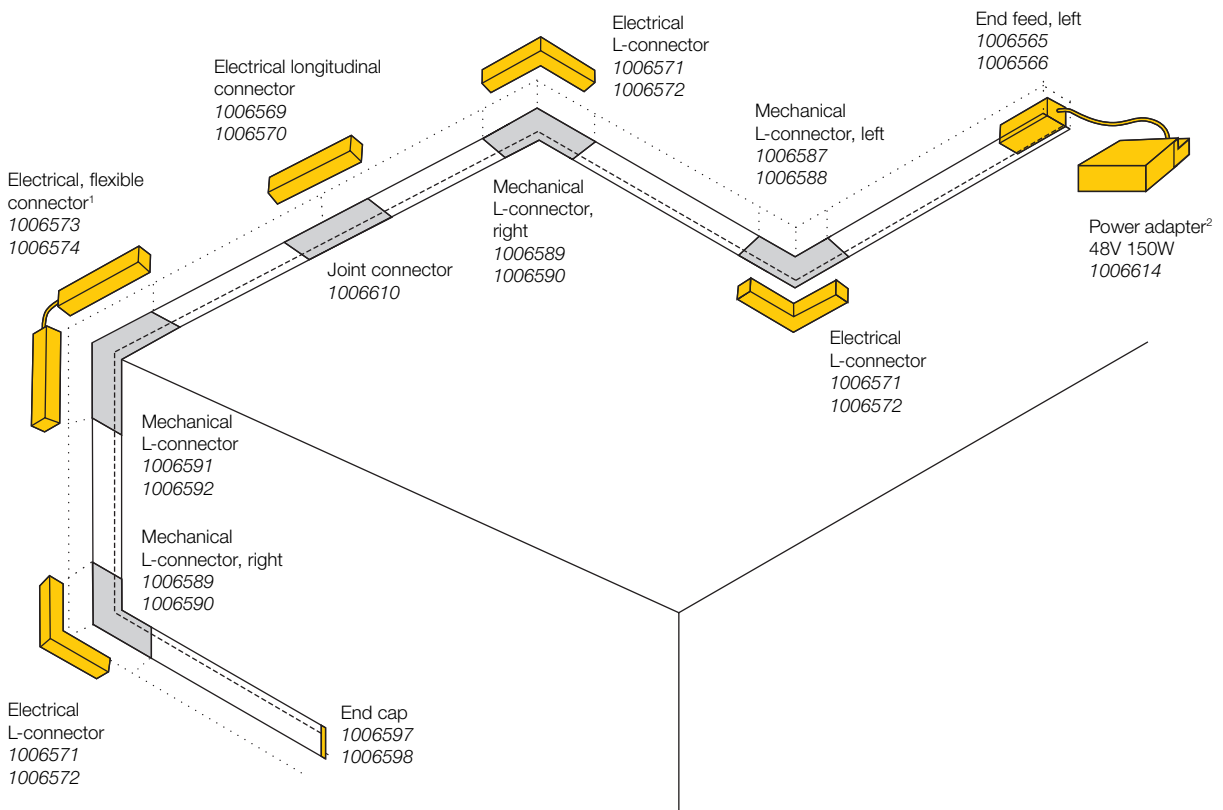

¹ Please note that electrical and mechanical connectors must always be installed together.
² Power adapter must be placed externally.

**End feed, right**16A max. | polycarbonate (PC)
L: 9.7 cm | W: 1.6 cm | H: 1.9 cm

- black Prod. no. **1006567**
- white **1006568**

Power adapter 48V | 60WPolycarbonate (PC)
L: 18 cm | W: 4.5 cm | H: 2.7 cm

- white Prod. no. **1006613**

End feed, left16A max. | polycarbonate (PC)
L: 9.7 cm | W: 1.6 cm | H: 1.9 cm

- black Prod. no. **1006565**
- white **1006566**

Power adapter 150W | 48VMetal/polycarbonate (PC)
L: 19.05 cm | W: 8.8 cm | H: 3.55 cm

- black Prod. no. **1006614**

L-connector mechanical f. recessed track deep, right (f. ceiling installation)aluminium
L: 9.5 cm | W: 9.5 cm | H: 4.7 cm

- black Prod. no. **1006589**
- white **1006590**

Track cover, 26mm, 2 mPolycarbonate (PC)
L: 200 cm | W: 26 cm | H: 6 cm

- black Prod. no. **1007188**
- white **1007189**

L-connector mechanical f. mounting track deep, left (f. ceiling installation)aluminium
L: 9.5 cm | W: 9.5 cm | H: 4.7 cm

- black Prod. no. **1006587**
- white **1006588**

End cap f. recessed trackPolycarbonate (PC)
L: 3.4 cm | W: 0.2 cm | H: 4.7 cm

- black Prod. no. **1006597**
- white **1006598**

L-connector mechanical, f. recessed track deep, stereo, (wall/ceiling)aluminium
L: 8.1 cm | W: 7.4 cm | H: 8.1 cm

- black Prod. no. **1006591**
- white **1006592**

Track reinforcement plates set f. recessed trackSteel
L: 6.3 cm | W: 0.76 cm | H: 0.25 cm

- grey Prod. no. **1006610**

Electric L-connector, DALI16A max. | polycarbonate (PC)
L: 11.4 cm | W: 11.4 cm | H: 1.9 cm

- black Prod. no. **1006571**
- white **1006572**

Track reinforcement plate with mounting set, 3m wire ropeSteel
L: 12 cm | W: 2.7 cm

- black Prod. no. **1006603**
- white **1006604**

Electric longitudinal connector, DALI16A max. | polycarbonate (PC)
L: 14.4 cm | W: 1.6 cm | H: 1.9 cm

- black Prod. no. **1006569**
- white **1006570**

Track reinforcement plate with mounting set, 1m rodSteel
L: 12 cm | W: 2.7 cm

- black Prod. no. **1006601**
- white **1006602**

Flexible connector, electrical, DALI16A max. | polycarbonate (PC)
L: 23 cm | W: 1.6 cm | H: 1.9 cm

- black Prod. no. **1006573**
- white **1006574**

Pendant suspension, 1m rodSteel
W: 2.9 cm

- black Prod. no. **1006605**
- white **1006606**

Transformer housing incl. end feed right, DALIPolycarbonate (PC)
L: 23.3 cm | W: 10.1 cm | H: 4.1 cm

- black Prod. no. **1007137**
- white **1007138**

Pendant suspension, 3m wire ropeSteel
W: 2.9 cm

- black Prod. no. **1006607**
- white **1006608**

Transformer housing incl. end feed left, DALIPolycarbonate (PC)
L: 23.3 cm | W: 10.1 cm | H: 4.1 cm

- black Prod. no. **1007083**
- white **1007084**

Mounting bracketaluminium
L: 3 cm | W: 2.72 cm | H: 1.05 cm

- black Prod. no. **1006599**
- white **1006600**

1006635 + 1006729 475 + 469

NUMINOS® XS
48V, DALI

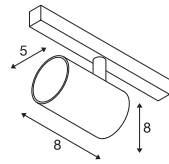
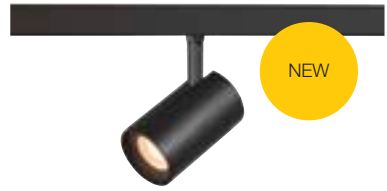

NUMINOS® S
48V, DALI

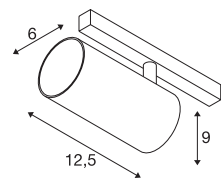



NUMINOS® SPOT 48V

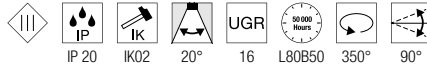

XS 48V | 200mA
Total wattage: 8.7W
Material: aluminium/polycarbonate (PC)

S 48V | 350mA
Total wattage: 16W
Material: aluminium/polycarbonate (PC)

		2700K	20°	640lm	1006651	100lm	1006705
			40°	620lm	1006654	970lm	1006708
			55°	640lm	1006657	960lm	1006711
		3000K	20°	700lm	1006669	1060lm	1006723
			40°	670lm	1006672	1030lm	1006726
			55°	690lm	1006675	1030lm	1006729
		2700K	20°	670lm	1006652	1020lm	1006706
			40°	650lm	1006655	1050lm	1006709
			55°	670lm	1006658	1030lm	1006712
		3000K	20°	730lm	1006670	1120lm	1006724
			40°	700lm	1006673	1120lm	1006727
			55°	720lm	1006676	1120lm	1006730
		2700K	20°	670lm	1006653	960lm	1006707
			40°	650lm	1006656	1000lm	1006710
			55°	670lm	1006659	980lm	1006713
		3000K	20°	730lm	1006671	1050lm	1006725
			40°	700lm	1006674	1050lm	1006728
			55°	720lm	1006677	1050lm	1006731
		2700K	20°	670lm	1006661	1020lm	1006715
			40°	650lm	1006664	1050lm	1006718
			55°	670lm	1006667	1030lm	1006721
		3000K	20°	730lm	1006679	1120lm	1006733
			40°	700lm	1006682	1120lm	1006736
			55°	720lm	1006685	1120lm	1006739
		2700K	20°	640lm	1006660	1000lm	1006714
			40°	620lm	1006663	970lm	1006717
			55°	640lm	1006666	960lm	1006720
		3000K	20°	700lm	1006678	1060lm	1006732
			40°	670lm	1006681	1030lm	1006735
			55°	690lm	1006684	1030lm	1006738
		2700K	20°	670lm	1006662	960lm	1006716
			40°	650lm	1006665	1000lm	1006719
			55°	670lm	1006668	980lm	1006722
		3000K	20°	730lm	1006680	1050lm	1006734
			40°	700lm	1006683	1050lm	1006737
			55°	720lm	1006686	1050lm	1006740



Product	Prod. no.
Elliptical diffuser XS	
● transparent	1005612
Prismatic diffuser XS	
● transparent	1005613
Frosted diffuser XS	
○ frosted	1005614
Honeycomb diffuser XS	
● black	1005615



Product	Prod. no.
Elliptical diffuser S	
● transparent	1004786
Prismatic diffuser S	
● transparent	1004787
Frosted diffuser S	
○ frosted	1004788
Honeycomb diffuser S	
● black	1004789

These lights are also available as 4000K versions on request (except XS). Please note the different delivery times and minimum order quantities.

1006844 471

NUMINOS® XS
48V, DALI

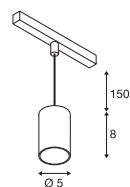

NUMINOS® S
48V, DALI

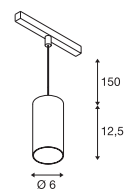



NUMINOS® PENDANT LIGHT 48V

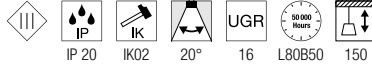

XS 48V | 200mA
Total wattage: 8.7W
Material: aluminium/polycarbonate (PC)

S 48V | 350mA
Total wattage: 16W
Material: aluminium/polycarbonate (PC)

	Dali	2700K	20°	460lm	1006759
			40°	620lm	1006762
			55°	640lm	1006765
	Dali	3000K	20°	700lm	1006777
			40°	670lm	1006780
			55°	690lm	1006783
	Dali	2700K	20°	670lm	1006760
			40°	650lm	1006763
			55°	670lm	1006766
	Dali	3000K	20°	730lm	1006778
			40°	700lm	1006781
			55°	720lm	1006784
	Dali	2700K	20°	670lm	1006761
			40°	650lm	1006764
			55°	670lm	1006767
	Dali	3000K	20°	730lm	1006779
			40°	700lm	1006782
			55°	720lm	1006785
	Dali	2700K	20°	670lm	1006769
			40°	650lm	1006772
			55°	670lm	1006775
	Dali	3000K	20°	730lm	1006787
			40°	700lm	1006790
			55°	720lm	1006793
	Dali	2700K	20°	620lm	1006771
			40°	640lm	1006768
			55°	640lm	1006774
	Dali	3000K	20°	700lm	1006786
			40°	670lm	1006789
			55°	690lm	1006792
	Dali	2700K	20°	670lm	1006770
			40°	650lm	1006773
			55°	670lm	1006776
	Dali	3000K	20°	730lm	1006788
			40°	700lm	1006791
			55°	720lm	1006794

1000lm	1006813
970lm	1006816
960lm	1006819
1060lm	1006831
1030lm	1006834
1030lm	1006837
1020lm	1006814
1050lm	1006817
1030lm	1006820
1120lm	1006832
1120lm	1006835
1120lm	1006838
960lm	1006815
1000lm	1006818
980lm	1006821
1050lm	1006833
1050lm	1006836
1050lm	1006839
1020lm	1006823
1050lm	1006826
1030lm	1006829
1120lm	1006841
1120lm	1006844
1120lm	1006847
1000lm	1006822
970lm	1006825
960lm	1006828
1060lm	1006840
1030lm	1006843
1030lm	1006846
960lm	1006824
1000lm	1006827
980lm	1006830
1050lm	1006842
1050lm	1006845
1050lm	1006848



Product	Prod. no.
Elliptical diffuser XS	
● transparent	1005612
Prismatic diffuser XS	
● transparent	1005613
Frosted diffuser XS	
○ frosted	1005614
Honeycomb diffuser XS	
● black	1005615



Product	Prod. no.
Elliptical diffuser S	
● transparent	1004786
Prismatic diffuser S	
● transparent	1004787
Frosted diffuser S	
○ frosted	1004788
Honeycomb diffuser S	
● black	1004789

These lights are also available as 4000K versions on request (except XS). Please note the different delivery times and minimum order quantities.

1006654 + 1006633 + 1006627 469 + 475 + 473





IN-LINE 22 48V, opal, DALI



NEW

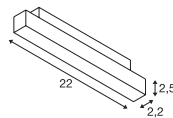

48V | 350mA
Power consumption: 6W
Total wattage: 7.3W
Material: aluminium



Down 540lm | 2700K
570lm | 3000K

Options	Prod. no.
● black 540lm 2700K	1006615 ●
● black 570lm 3000K	1006617 ●
○ white 540lm 2700K	1006616 ●
○ white 570lm 3000K	1006618 ●

IN-LINE 22 48V, Darklight Reflector, DALI



NEW

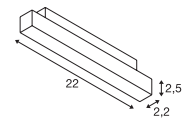

48V | 350mA
Power consumption: 6W
Total wattage: 7.3W
Material: aluminium/polycarbonate (PC)



Down 580lm | 2700K
610lm | 3000K

Options	Prod. no.
● black 580lm 2700K	1006627 ●
● black 610lm 3000K	1006629 ●
○ white 580lm 2700K	1006628 ●
○ white 610lm 3000K	1006630 ●



[1006633](tel:1006633) + [1006654](tel:1006654) [475+469](tel:475469)





IN-LINE 44
48V, opal, DALI

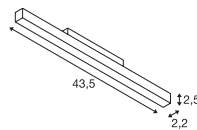

48V | 350mA
Power consumption: 12W
Total wattage: 14W
Material: aluminium/polycarbonate (PC)



Down 1140lm | 2700K
1180lm | 3000K

Options	Prod. no.
● black 1140lm 2700K	1006621 ●
● black 1180lm 3000K	1006623 ●
○ white 1140lm 2700K	1006622 ●
○ white 1180lm 3000K	1006624 ●

IN-LINE 44
48V, Darklight Reflector, DALI

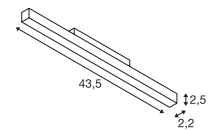
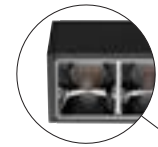

48V | 350mA
Power consumption: 12W
Total wattage: 14W
Material: aluminium



Down 1180lm | 2700K
1230lm | 3000K

Options	Prod. no.
● black 1180lm 2700K	1006633 ●
● black 1230lm 3000K	1006635 ●
○ white 1180lm 2700K	1006634 ●
○ white 1230lm 3000K	1006636 ●



1006682 + 1006648 469 + 477





IN-LINE 24

48V, Move, Darklight Reflector, DALI



NEW

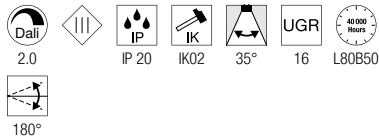
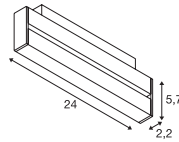

48V | 350mA
 Power consumption: 6W
 Total wattage: 7.3W
 Material: aluminium/polycarbonate (PC)



Down 580lm | 2700K
 610lm | 3000K

Options	Prod. no.
● black 580lm 2700K	1006639
● black 610lm 3000K	1006641
○ white 580lm 2700K	1006640
○ white 610lm 3000K	1006642

IN-LINE 46

48V, Move, Darklight Reflector, DALI



NEW

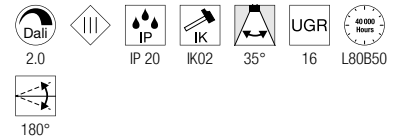
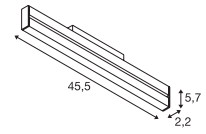

48V | 350mA
 Power consumption: 12W
 Total wattage: 14W
 Material: aluminium/polycarbonate (PC)



Down 1180lm | 2700K
 1230lm | 3000K

Options	Prod. no.
● black 1180lm 2700K	1006645
● black 1230lm 3000K	1006647
○ white 1180lm 2700K	1006646
○ white 1230lm 3000K	1006648

DESIGN YOUR 48V SYSTEM

Select your track version in the appropriate length, desired colour and preferred installation method. Choose the recessed version or one of the two surface-mounted versions. With the NUMINOS® and IN-LINE lights specially designed for the SLV 48V system, they are particularly flexible and perfectly set the scene for their surroundings.

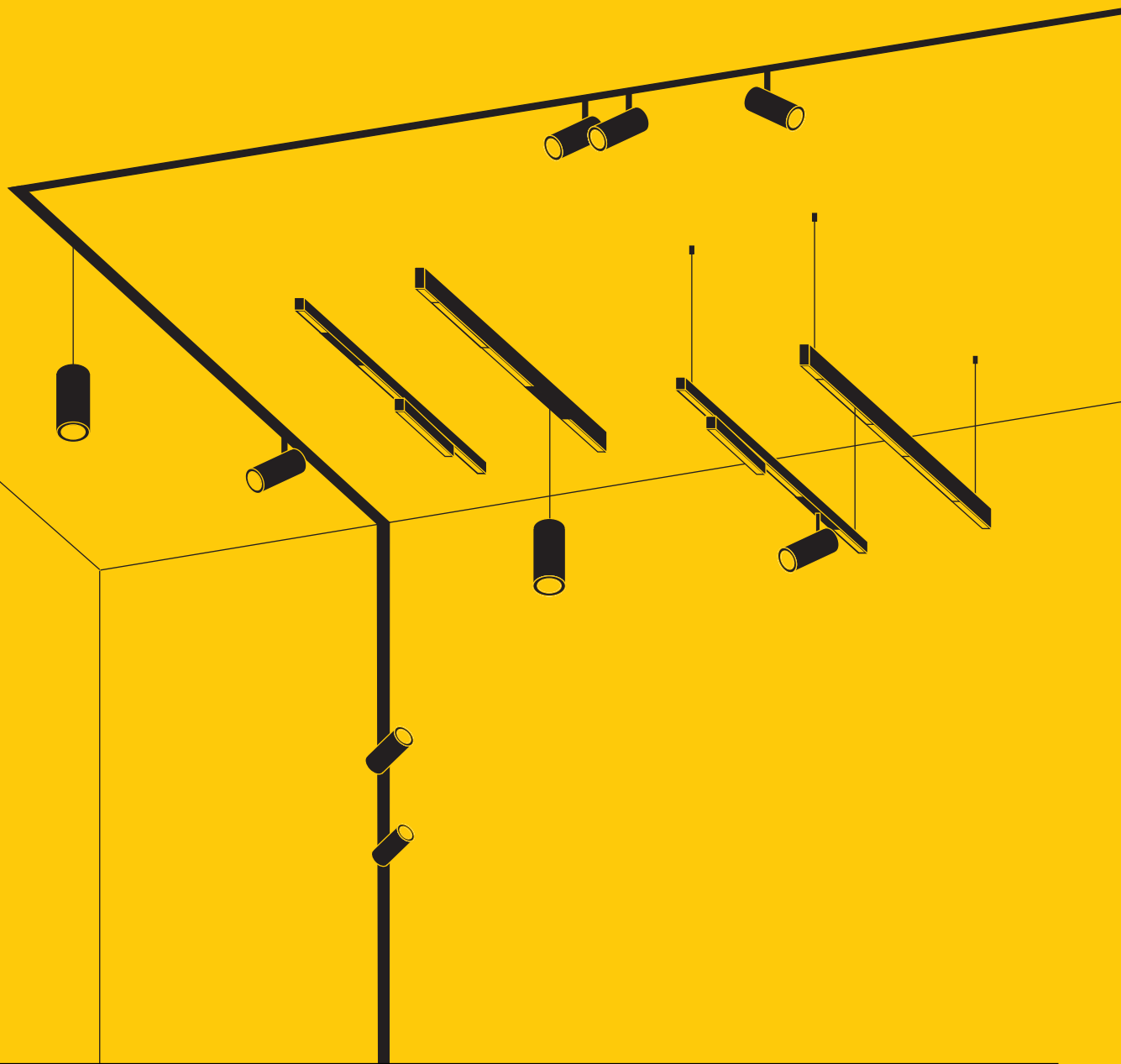

CHOOSE YOUR TRACK

STANDARD MOUNTING TRACK



DEEP MOUNTING TRACK



RECESSED TRACK

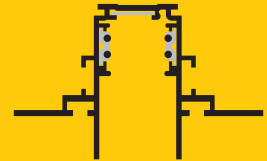

CHOOSE YOUR PREFERRED INSTALLATION

SURFACE-MOUNTED

RECESSED



Ceiling



Wall



Pendant



Ceiling



Wall



CHOOSE YOUR LIGHTS

NUMINOS®
SPOT AND PENDANT LIGHT

IN-LINE, IN-LINE DARKLIGHT REFLECTOR
AND IN-LINE MOVE



CHOOSE YOUR ACCESSORIES

VARIOUS CONNECTORS, COVERS, SUSPENSIONS, POWER ADAPTERS, ETC.

139100 489





SCKET

ASMARA | 486



SCKET

TELESKOP | 486



SCKET

COSMIC | 487



SCKET

SYROS | 489



SCKET

SALUNA | 489



LED

DURNO | 489



LED

PLYTTA | 490



LED

NOBLO® SPOT | 491



LED

COMET LED | 491



SCKET

COMET | 491

TENSEO, Low-voltage cable 4mm², 10m



	10 m	10 m	10 m
Max. voltage (V)	48	48	48
Max. current (A)	25	25	25
Colour	● black	○ white	○ transparent
Material	Copper/plastic	Copper/plastic	Copper/plastic
Diameter (cm)/Length (cm)	0,4 / 1000	0,4 / 1000	0,4 / 1000
Prod. no.	1002602	1002603	1002604

TENSEO, Low-voltage cable 4mm², 20m



	20 m	20 m	20 m
Max. voltage	48	48	48
Max. current (A)	25	25	25
Colour	● black	○ white	○ transparent
Material	Copper/plastic	Copper/plastic	Copper/plastic
Diameter (cm)/Length (cm)	0,4 / 2000	0,4 / 2000	0,4 / 2000
Prod. no.	139030	139031	139024



TENSEO, Low-voltage cable 4mm², 100m



	100 m	100 m	100 m
Max. voltage (V)	48	48	48
Max. current (A)	25	25	25
Colour	● black	○ white	○ transparent
Material	Copper/plastic	Copper/plastic	Copper/plastic
Diameter (cm)/Length (cm)	0,4 / 10000	0,4 / 10000	0,4 / 10000
Prod. no.	139040	139041	139004

TENSEO, Low-voltage cable 6mm², 20m



	20 m	20 m	20 m
Max. voltage (V)	48	48	48
Max. current (A)	25	25	25
Colour	● black	○ white	○ transparent
Material	Copper/plastic	Copper/plastic	Copper/plastic
Diameter (cm)/Length (cm)	0,6 / 2000	0,6 / 2000	0,6 / 2000
Prod. no.	139050	139051	139026

TENSEO, Low-voltage cable 6mm², 100m



	100 m	100 m	100 m
Max. voltage (V)	48	48	48
Max. current (A)	25	25	25
Colour	● black	○ white	○ transparent
Material	Copper/plastic	Copper/plastic	Copper/plastic
Diameter (cm)/Length (cm)	0,6 / 10000	0,6 / 10000	0,6 / 10000
Prod. no.	139060	139061	139006



139131 489



12V AC | 50VA conventional

Steel/brass
H: 11 cm Diameter: 11.1 cm

- black Prod. no. **1002691**
- white **1002692**
- chrome **1002693**



12V AC | 105VA conventional

Steel/brass
H: 11 cm Diameter: 11.1 cm

- white Prod. no. **138981**
- chrome **138982**



12V AC | 210VA conventional

Steel/brass
H: 11 cm Diameter: 13.5 cm

- white Prod. no. **138991**
- chrome **138992**



Cord tightener

25A max. | brass
H: 11 cm Diameter: 1 cm

- black Prod. no. **181530**
- white **181531**
- chrome **181532**



Wall bracket

Steel/brass
L: 3 cm Diameter: 5 cm

- black Prod. no. **186300**
- white **186301**
- chrome **186302**



Diverter 6cm

Steel/brass
H: 6 cm Diameter: 5 cm

- black Prod. no. **186330**
- white **186331**
- chrome **186332**



Redirector

Steel/brass
H: 16 cm Diameter: 5 cm

- black Prod. no. **186340**
- white **186341**
- chrome **186342**



Wall bracket 10cm

Steel/brass
H: 11.5 cm Diameter: 5 cm, With clamping device

- black Prod. no. **186310**
- white **186311**
- chrome **186312**



Ceiling diverter

Steel/brass
H: 16 cm Diameter: 5 cm

- black Prod. no. **186640**
- white **186641**
- chrome **186642**



Feed-in

25A max. | brass
H: 1.8 cm Diameter: 1 cm

- black Prod. no. **186350**
- white **186351**
- chrome **186352**



Insulating connector

25A max. | aluminium / plastic
L: 6.4 cm Diameter: 1 cm

- black Prod. no. **186360**
- white **186361**
- chrome **186362**



Spacer

aluminium
W: 9 cm Diameter: 1.25 cm

- black Prod. no. **1002700**
- white **1002701**
- chrome **1002702**



Electrical spacer

25A max. | brass
H: 9 cm Diameter: 1.25 cm

- black Prod. no. **1002703**
- white **1002704**
- chrome **1002705**



Suspension kit 2m

Steel/aluminium
W: 18.6 cm Diameter: 1.25 cm

- black Prod. no. **1002697**
- white **1002698**
- chrome **1002699**



ASMARA LV, QR-C51

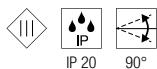
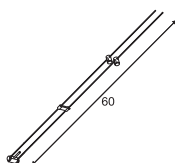

12V ~50Hz
Material: stainless steel



Base: 1xGX5.3

Options	Prod. no.
● black	139070
○ white	139071
● chrome	139072



LED GU5.3 | 5.8W | 36°
2700K | 450lm | EEK=G
6kWh/1000h

Prod. no.: 1001574



TELESKOP LV, QR-C51

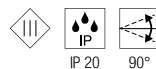

12V ~50Hz
Material: steel

- Telescope adjustable from 21-51cm



Base: 1xGX5.3

Options	Prod. no.
● black	139080
○ white	139081
● chrome	139082



LED GU5.3 | 5.8W | 36°
2700K | 450lm | EEK=G
6kWh/1000h

Prod. no.: 1001574

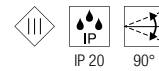
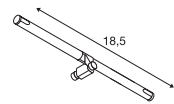

**COSMIC**
LV, QR-C51**139090** **487**12V ~50Hz
Material: steel/brass**SOCKET**
INSIDE  **<35**
W

Base: 1xGX5.3

Options	Prod. no.
● black	139090
○ white	139091
● chrome	139092

LED GU5.3 | 5.8W | 36°
2700K | 450lm | EEK=G
6kWh/1000h**Prod. no.: 1001574**

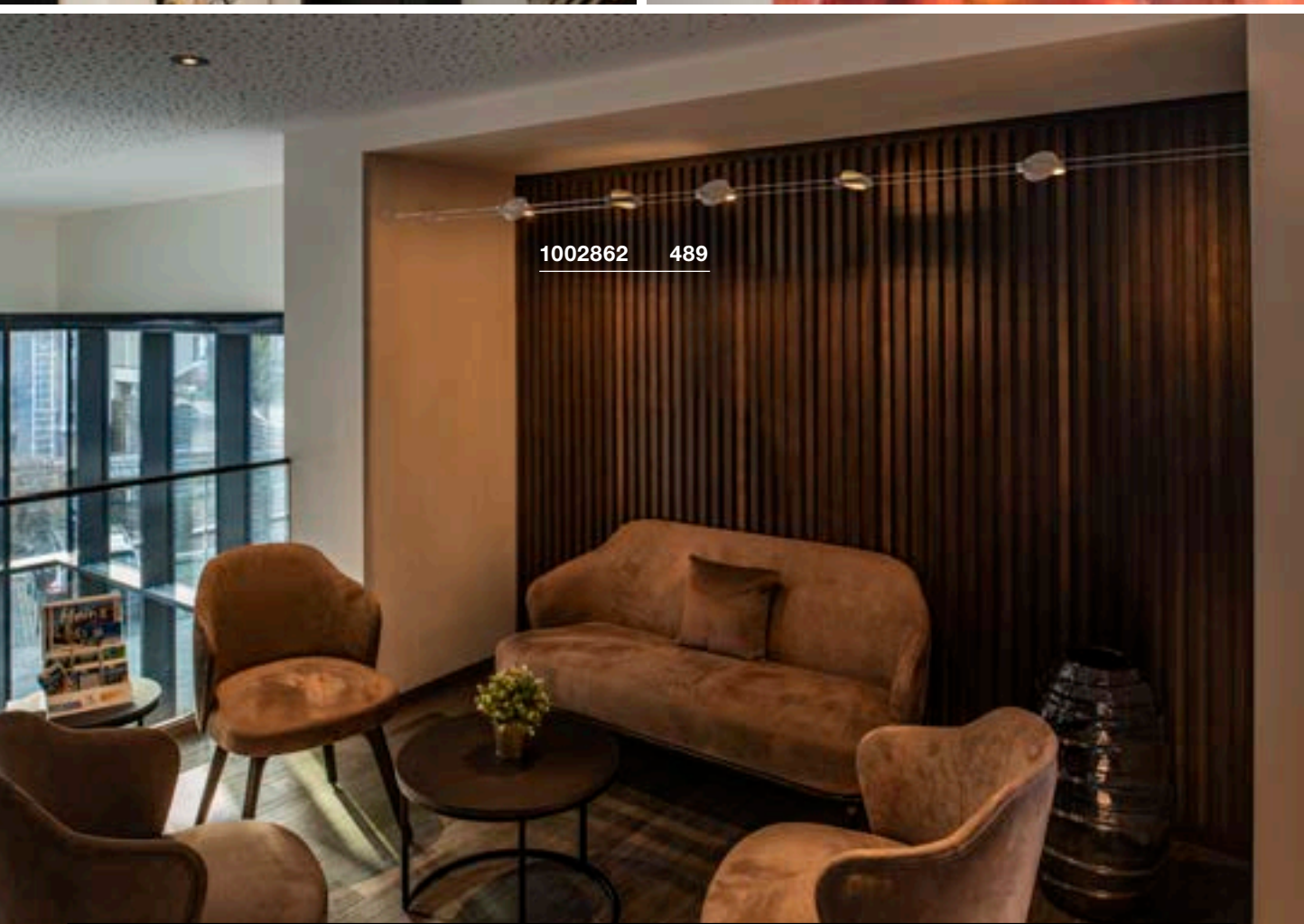
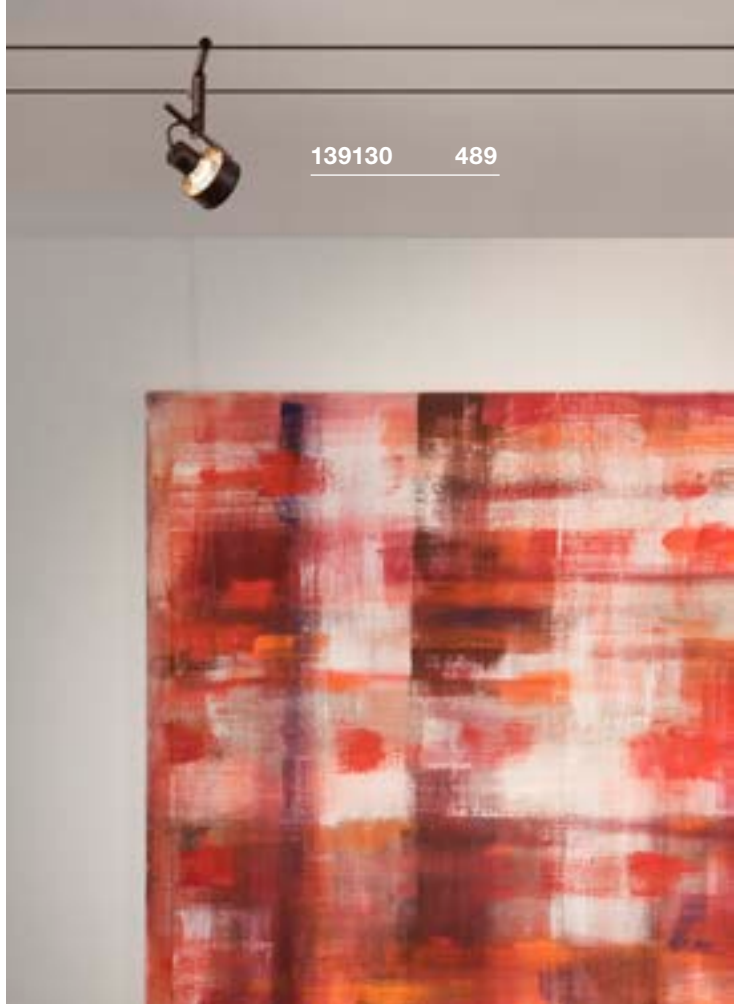



SYROS
LV, QR-C51

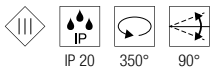
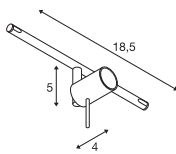

12V ~50Hz
Material: steel



Base: 1xGX5.3

Options	Prod. no.
● black	139100
○ white	139101
● chrome	139102



LED GU5.3 | 5.8W | 36°
2700K | 450lm | EEK=G
6kWh/1000h

Prod. no.: 1001574

SALUNA
LV, QR-C51

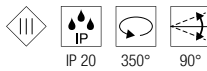
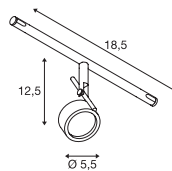

12V ~50Hz
Material: steel/brass



Base: 1xGX5.3

Options	Prod. no.
● black	139130
○ white	139131
● chrome	139132



LED GU5.3 | 5.8W | 36°
2700K | 450lm | EEK=G
6kWh/1000h

Prod. no.: 1001574

DURNO
LV

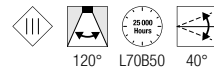
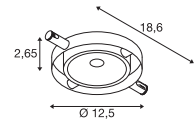

12V ~50Hz
Power consumption: 6W
Material: aluminium/stainless steel



Down

360lm | 2700K

Options	Prod. no.
● black	1002861
○ white	1002862
● chrome/stainless steel	1002863

1002864 490



PLYTTA LV

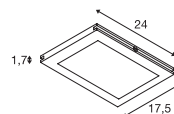

1002690 491



12V ~50Hz
Power consumption: 9.8W
Material: aluminium/plastic



Down

750lm | 2700K

Options	Prod. no.
● black CRI80	1002864
○ white CRI90	1002865
● chrome CRI90	1002866



NOBLO® SPOT LV, Rope Track

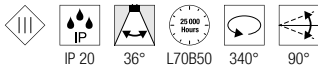
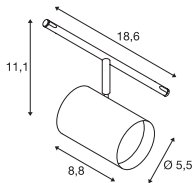

12V ~50Hz
Power consumption: 8.5 W
Material: aluminium



Down 420lm | 2700K
450lm

Options	Prod. no.
● black 420lm	1002694
○ white 450lm	1002695
● chrome 450lm	1002696

COMET LED LV

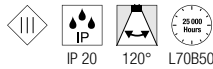
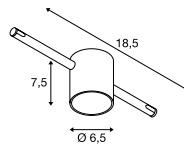

12V ~50Hz
Power consumption: 6.6W
Material: aluminium/glass



Down 410lm | 2700K

Options	Prod. no.
● chrome/frosted	1002690

COMET LV, QR-C51

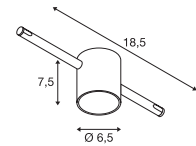

12V ~50Hz
Material: brass



Base: 1xGX5.3

Options	Prod. no.
● black	139120
○ white	139121
● chrome	139122



LED GU5.3 | 5.8W | 36°
2700K | 450lm | EEK=G
6kWh/1000h

Prod. no.: **1001574**



1007354 503





NEW

LED
NOBLO® SPOT | 501



NEW

LED
NOBLO® SPOT | 501



NEW

LED
NOBLO® SPOT | 503



NEW

LED
NOBLO® SPOT | 503



NEW

SCKET
ASTO TUBE | 505

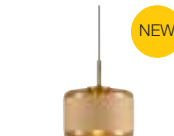

NEW

SCKET
PANTILO
ROPE 19 | 505



LED
HELIA 50 TRACK | 507



LED
PANEL TRACK | 507



LED
PANEL TRACK | 507



SCKET
PARA CONE GL | 508



SCKET
PARA CONE GL | 508



SCKET
PARA CONE 14 | 509



SCKET
PARA CONE 14 | 509



SCKET
TONGA® | 511



SCKET
LIGHT EYE® 90 | 511



SCKET
LIGHT EYE® 150 | 511



SCKET
FORCHINI M 40
TRACK | 512



SCKET
PURI TRACK | 513



SCKET
PURI TRACK | 513



SCKET
PURI TRACK | 515



SCKET
AVO TRACK | 515



LED
ENOLA C TRACK | 516



LED
ENOLA C TRACK | 517



SCKET
ENOLA B TRACK | 517



SCKET
ENOLA B | 517



SCKET
BIMA | 519



SCKET
BIMA | 519



LED
KALU TRACK | 520



SCKET
KALU TRACK | 520



SCKET
EURO SPOT
TRACK | 521



SCKET
ALTRA DICE
TRACK | 521

1000713 511



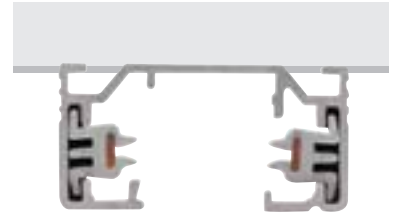

1-PHASE

MOUNTING TRACK



	1 m	1 m	1 m
Nominal voltage (V)	220-240V ~50/60Hz	250V ~50/60Hz	220-240V ~50/60Hz
Max. current (A)	16	16	16
Colour	● black	○ white	● grey
Material	aluminium	aluminium	aluminium
L x W x H (cm)	100 x 3.5 x 1.8	100 x 3.5 x 1.8	100 x 3.5 x 1.8
Prod. no.	143010	143011	143012

	2 m	2 m	2 m
Nominal voltage (V)	220-240V ~50/60Hz	250V ~50/60Hz	220-240V ~50/60Hz
Max. current (A)	16	16	16
Colour	● black	○ white	● grey
Material	aluminium	aluminium	aluminium
L x W x H (cm)	200 x 3.5 x 1.8	200 x 3.5 x 1.8	200 x 3.5 x 1.8
Prod. no.	143020	143021	143022

	3 m	3 m	3 m
Nominal voltage (V)	250V ~50/60Hz	250V ~50/60Hz	250V ~50/60Hz
Max. current (A)	16	16	16
Colour	● black	○ white	● grey
Material	aluminium	aluminium	aluminium
L x W x H (cm)	300 x 3.5 x 1.8	300 x 3.5 x 1.8	300 x 3.5 x 1.8
Prod. no.	1002151	1002152	1002153

1-PHASE

Mounting track
Planning tools and accessories at a glance

View of components from above on
the installation side

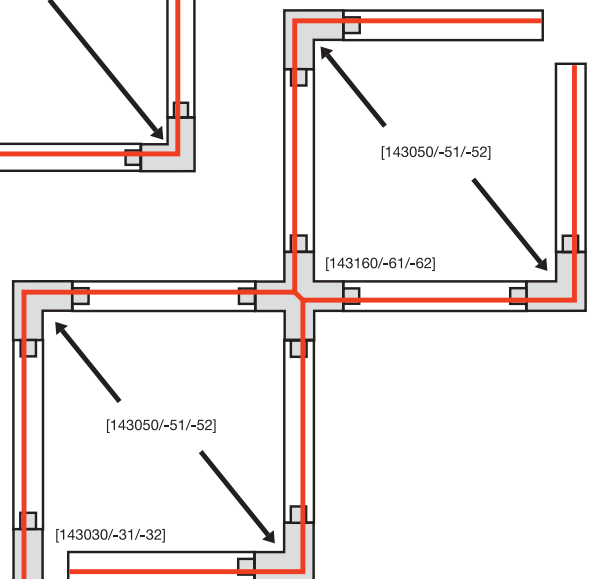
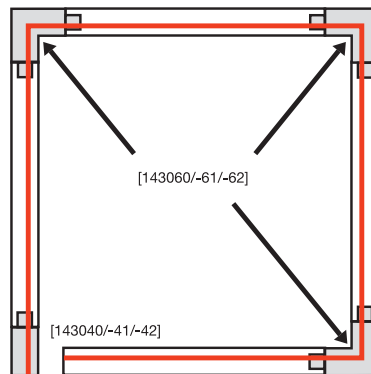
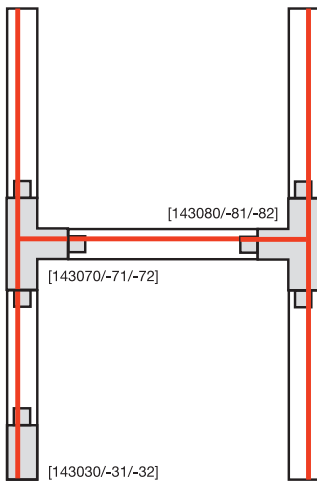
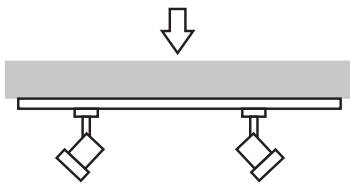

**Feed-in, earth left**

16 A max. | polycarbonate (PC)
L: 6.5 cm | W: 3.5 cm | H: 1.8 cm

- black Prod. no. **143030**
- white **143031**
- grey **143032**

**Stabiliser, longitudinal connector**

Steel
L: 19.7 cm | W: 3.2 cm | H: 1.3 cm
For reinforcement when mounting several tracks with ceiling suspension (1002845)

- nickel Prod. no. **143151**

**Feed-in, earth right**

16 A max. | polycarbonate (PC)
L: 6.5 cm | W: 3.5 cm | H: 1.8 cm

- black Prod. no. **143040**
- white **143041**
- grey **143042**

**Stabiliser, corner connector long**

Steel
L: 11.5 cm | W: 11.5 cm | H: 0.5 cm
For reinforcement when mounting several tracks with ceiling suspension (1002845)

- nickel Prod. no. **143152**

**Longitudinal connector with feed capacity**

16 A max. | polycarbonate (PC)
L: 17.2 cm | W: 3.5 cm | H: 1.8 cm

- black Prod. no. **143100**
- white **143101**
- grey **143102**

**Stabilising X-connector**

Steel
L: 19.7 cm | W: 19.7 cm | H: 0.5 cm
For reinforcement when mounting several tracks with ceiling suspension (1002845).

- grey Prod. no. **143169**

**Longitudinal connector, electrical**

16 A max. | polycarbonate (PC)
L: 6.4 cm | W: 3.5 cm | H: 1.8 cm

- black Prod. no. **143090**
- white **143091**
- grey **143092**

**1-phase adapter**

6 A max. | polycarbonate (PC)
L: 8.5 cm | W: 3.5 cm | H: 3.2 cm

- black Prod. no. **143120**
- white **143121**
- grey **143124**

**Corner connector, earth inside**

16 A max. | polycarbonate (PC)
L: 10.4 cm | W: 10.4 cm | H: 1.8 cm

- black Prod. no. **143060**
- white **143061**
- grey **143062**

**1-phase adapter with hooks**

6 A max. | polycarbonate (PC)
L: 8.5 cm | W: 3.5 cm | H: 7.4 cm

- black Prod. no. **143170**
- white **143171**
- grey **143172**

**Corner connector, earth outside**

16 A max. | polycarbonate (PC)
L: 10.4 cm | W: 10.4 cm | H: 1.8 cm

- black Prod. no. **143050**
- white **143051**
- grey **143052**

**Cover**

Polycarbonate (PC)
L: 200 cm | W: 1.8 cm | H: 0.75 cm

- black Prod. no. **1004783**
- white **1004785**
- grey **1004784**

**T-connector, earth external, left**

16 A max. | polycarbonate (PC)
L: 17.2 cm | W: 10.4 cm | H: 1.8 cm

- black Prod. no. **143070**
- white **143071**
- grey **143072**

**End caps (2 pieces)**

Polycarbonate (PC)
L: 0.4 cm | W: 3.5 cm | H: 1.8 cm

- black Prod. no. **143130**
- white **143131**
- grey **143132**

**T-connector, earth external, right**

16 A max. | polycarbonate (PC)
L: 17.2 cm | W: 10.4 cm | H: 1.8 cm

- black Prod. no. **143080**
- white **143081**
- grey **143082**

**Ceiling rosette**

6 A max. | polycarbonate (PC)
H: 2.5 cm Diameter: 11.5 cm

- black Prod. no. **143380**
- white **143381**
- grey **143382**

**X-connector**

16 A max. | polycarbonate (PC)
L: 9.5 cm | W: 17.2 cm | H: 1.8 cm

- black Prod. no. **143160**
- white **143161**
- grey **143162**

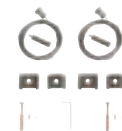
**Wire rope suspension (2 pieces)**

Stainless steel/brass
L: 500cm

- nickel Prod. no. **1002845**

**Flex connector**

16 A max. | polycarbonate (PC)
L: 16.4 cm | W: 3.5 cm | H: 1.8 cm

- black Prod. no. **143110**
- white **143111**
- grey **143112**

143580 507





1-PHASE

Recessed track with matching accessories

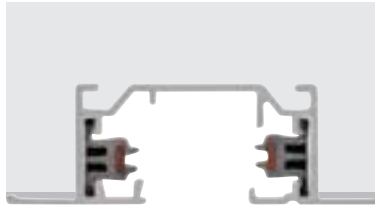

	2 m
Nominal voltage (V)	250V ~50/60Hz
Max. current (A)	16
Colour	○ white
Material	aluminium
L x W x H (cm)	200 x 5.5 x 1.8
Prod. no.	143221

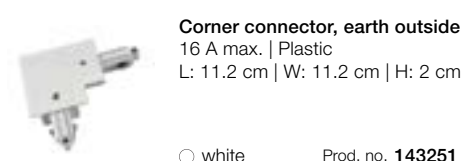
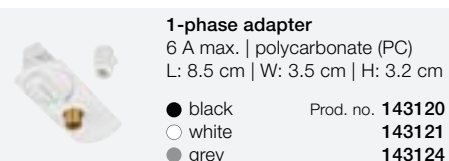
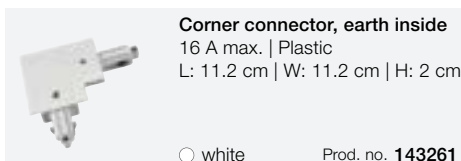
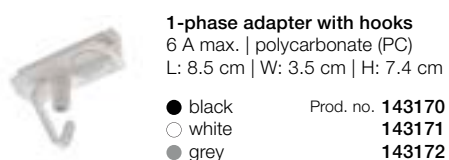
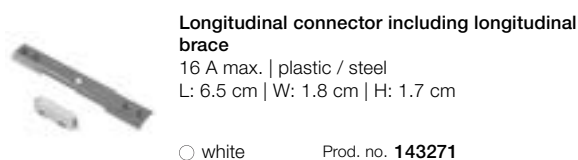
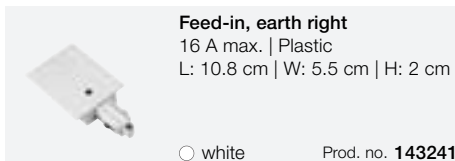
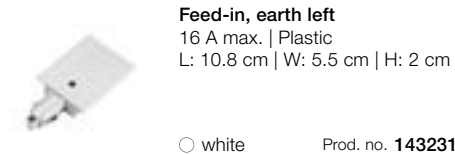

1007639 501





NOBLO® SPOT 1 phase, Triple Track Set

NOBLO® SPOT 1 phase, PHASE

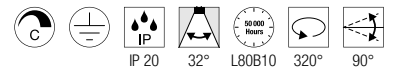
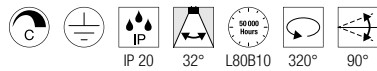
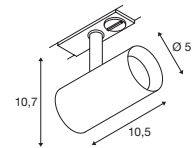
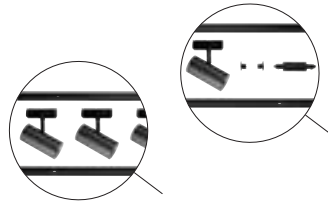
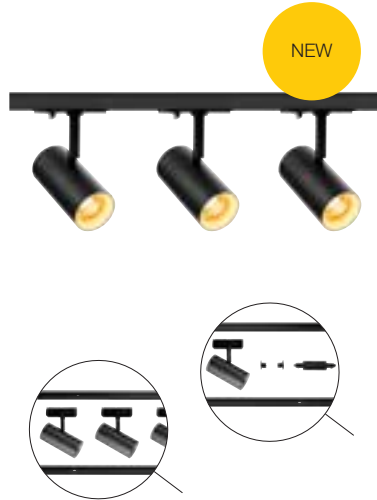

220-240V ~50/60Hz | 150mA
Total wattage: 19 W
Material: aluminium

220-240V ~50/60Hz | 150mA
Total wattage: 6.2W
Material: aluminium/polycarbonate (PC)



Down 2250lm | 2700K

Down 740lm | 2700K

Options	Prod. no.
● black	1007673 ●
○ white	1007674 ●

Options	Prod. no.
● black	1007638 ●
○ white	1007639 ●
● grey	1007640 ●

1007352 503





NOBLO® SPOT 1 phase, PHASE

NOBLO® SPOT 1 phase, PHASE

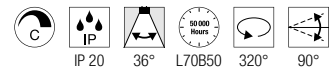
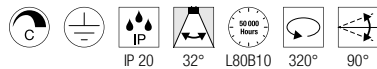
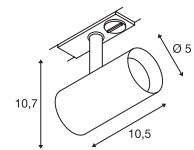
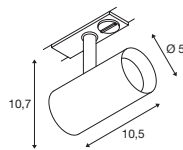

220-240V ~50/60Hz | 150mA
Total wattage: 6.2W
Material: aluminium/polycarbonate (PC)

220-240V ~50/60Hz | 350mA
Total wattage: 8.4W
Material: aluminium/polycarbonate (PC)



Down 750lm | 3000K

Down 30lm | 2000K - 450lm | 3000K

Options	Prod. no.
● black	1007641
○ white	1007642
● grey	1007643

Options	Prod. no.
● black	1007352
○ white	1007353
● grey	1007354

1006445 505





ASTO TUBE 1 phase, GU10

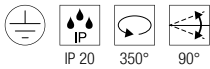
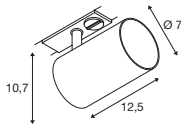

220-240V ~50/60Hz
Material: aluminium



Base: 1xGU10

Options	Prod. no.
● black	1006445 ●
○ white	1006446 ●



LED GU10 51mm | 6W | 38°
2700K | 450lm | EEK=F
6kWh/1000h



Prod. no.: 1005077

ASTO TUBE Decorative reflector



H: 3.95 cm
Diameter: 6.75 cm
Material: polycarbonate (PC)

Options	Prod. no.
● black/chrome	1007190 ●
● gold	1006450 ●
● chrome	1006449 ●
● copper	1006451 ●

PANTILO ROPE 19 PD, E27

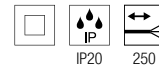
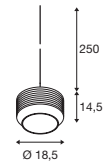

200-240V ~50/60Hz
Material: glass/steel/hemp

- Open cable end



Base: 1xE27

Max. diameter: 10 cm

L: 11 cm

Options	Prod. no.
● amber/gold	1007597 ●
● anthracite/silver	1007596 ●



A60 | 7.5W | 180°
2700K | 720lm | EEK=F
8kWh/1000h



Prod. no.: 1005305

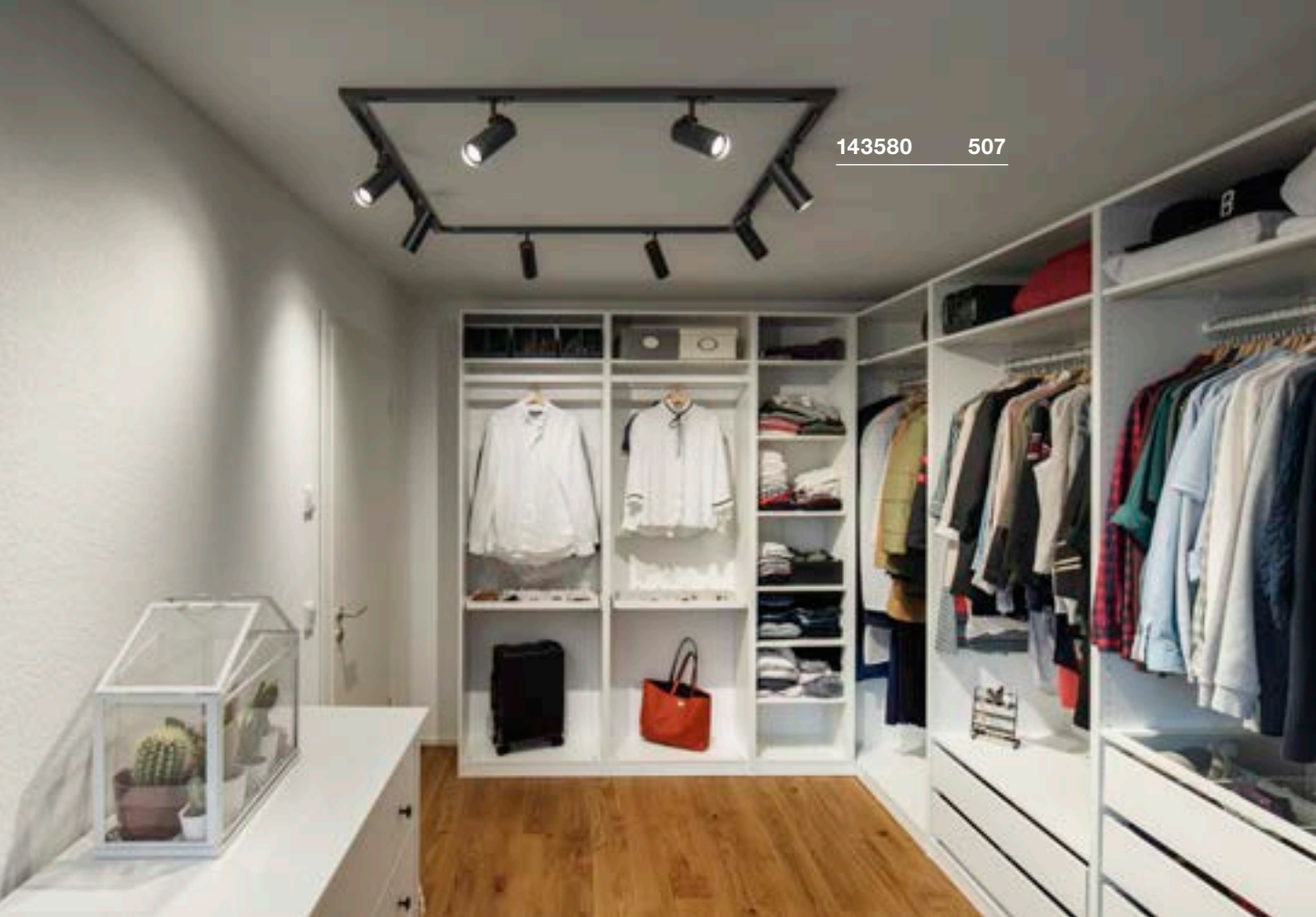

143580 507



1004934 507



1004935 507



HELIA 50 TRACK
1 phase

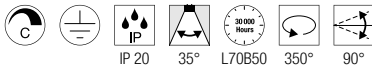
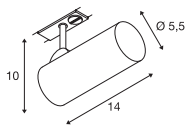

220-240V ~50/60Hz | 500mA
Total wattage: 11W
Material: aluminium



Down 810lm | 3000K
880lm

Options	Prod. no.
● black	
810lm	143580
○ white	
880lm	143581

PANEL TRACK
1 ph., square

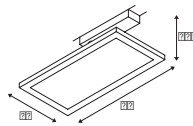

220-240V ~50/60Hz | 450mA
Total wattage: 18W
Material: polycarbonate (PC)/steel



Down 1800lm | 3000K

Options	Prod. no.
● black	1004933
○ white	1004934

PANEL TRACK
1 ph., round

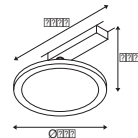

220-240V ~50/60Hz | 450mA
Total wattage: 18W
Material: polycarbonate (PC)/steel



Down 1800lm | 3000K

Options	Prod. no.
● black	1004935
○ white	1004936

PARA CONE GL
1 phase, GU10

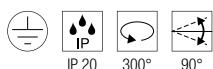
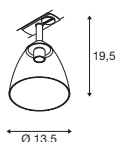

220-240V ~50/60Hz
Material: aluminium/glass



Base: 1xGU10

Options	Prod. no.
● black	1006155
○ white	1006156



LED GU10 51mm | 3.2W
2700K | 270lm | EEK=G



Prod. no.: 1006321

PARA CONE GL
PD, GU10

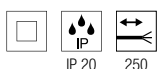
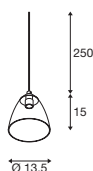

220-240V ~50/60Hz
Material: aluminium/glass

- Open cable end



Base: 1xGU10

Options	Prod. no.
● black	1006159
○ white	1006160



LED GU10 51mm | 3.2W
2700K | 270lm | EEK=G



Prod. no.: 1006321



Product	Prod. no.
1-phase adapter	
● black	143120
○ white	143121
● grey	143124

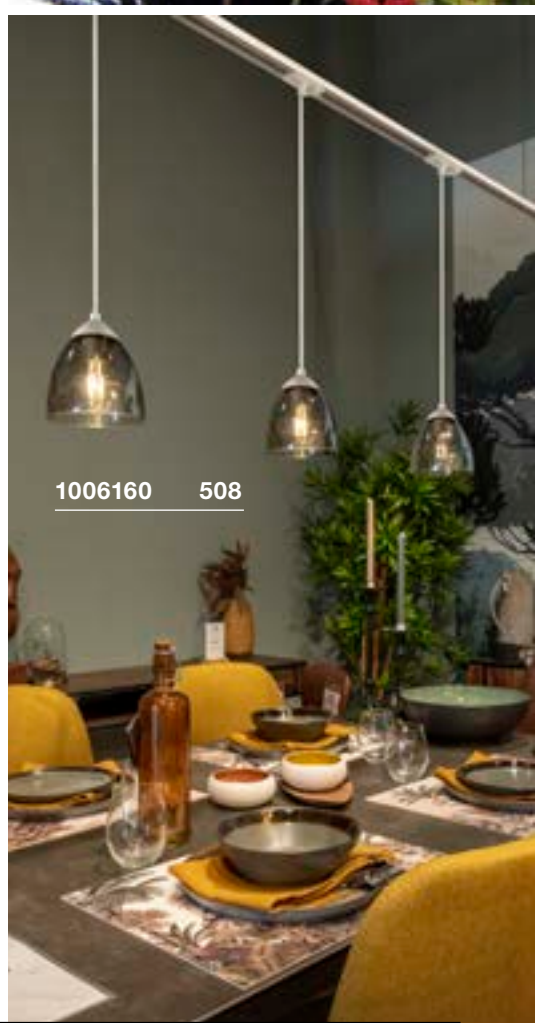

1006160 508



1006155 508

PARA CONE 14
1 phase, QPAR51

PARA CONE 14
1 phase, PD, QPAR51

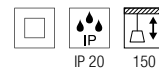
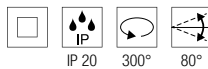
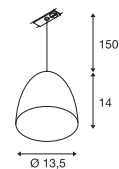
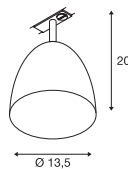

220-240V ~50/60Hz
Material: steel

220-240V ~50/60Hz
Material: aluminium

- Textile cable
- black/gold version with golden reflector
- all other versions with white reflector



1002875 509



Base: 1xGU10

Base: 1xGU10

Options	Prod. no.
● black	1002873
○ white	1002874
● copper	1002875

Options	Prod. no.
● black	143990
○ white	143991
● copper	1001968



LED GU10 51mm | 3.2W
2700K | 270lm | EEK=G



Prod. no.: 1006321



LED GU10 51mm | 3.2W
2700K | 270lm | EEK=G



Prod. no.: 1006321



143594

511



144011

511



1000713

511



TONGA®
1 phase, PD, E14

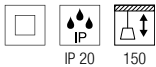
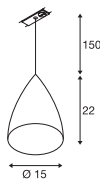

220-240V ~50/60Hz
Material: aluminium/glass



Base: 1xE14 Max. diameter: 5.1 cm L: 13 cm

Options	Prod. no.
● grey / milky	143594



C35 | 4.2W | 320°
2700K | 350lm | EEK=G
5kWh/1000h



Prod. no.: 1005285

LIGHT EYE® 90
1 phase, QPAR51

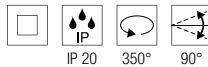
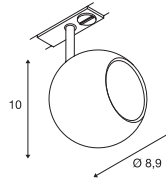

230V ~50/60Hz
Material: steel



Base: 1xGU10

Options	Prod. no.
● black	144010
○ white	144011
● copper	144019



LED GU10 51mm | 6W | 36°
2200-2700K | 360lm | EEK=G
6kWh/1000h



Prod. no.: 1005273

LIGHT EYE® 150
1 phase, PD, QPAR111

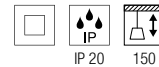
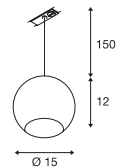

220-240V ~50/60Hz
Material: steel



Base: 1xGU10

Options	Prod. no.
● black	1000713
○ white	143621



LED GU10 51mm | 6W | 38°
2700K | 450lm | EEK=F
6kWh/1000h



Prod. no.: 1005077

FORCHINI M 40 TRACK
1 phase, E27

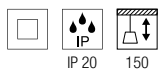
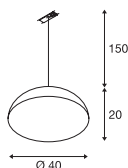

220-240V ~50/60Hz
Material: aluminium/steel

- Pendant light adapter colour silver-grey [143930] / black [143932]

SOCKET INSIDE <40 W

Base: 1xE27 Max. diameter: 6.8 cm L: 15.2 cm

Options	Prod. no.
● black/gold	143930
● black/gold	143932

A60 | 7.5W | 180°
2700K | 720lm | EEF=F
8kWh/1000h

Prod. no.: 1005305



143932 512



1001868 513



PURI TRACK
1 phase, Triple Track Set

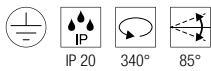
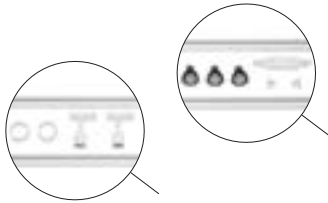

220-240V ~50/60Hz
Total wattage: 4.3W
Material: aluminium

- Consists of 2 x 1 m tracks.
1 longitudinal connector with feed-in.
1 x 2 end caps.
3 x PURI light head.
3 x LED GU10 lamp.
3 x decorative ring for GU10

Options	Prod. no.
● black	143190
○ white	143191

PURI TRACK
1 phase, QPAR51

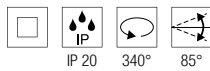
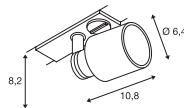

220-240V ~50/60Hz
Material: aluminium/plastic



Base: 1xGU10

Options	Prod. no.
● black	1001868
○ white	1001869



LED GU10 51mm | 6W | 38°
2700K | 450lm | EEK=F
6kWh/1000h



Prod. no.: 1005077

PURI TRACK
1 phase, QPAR51

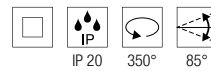
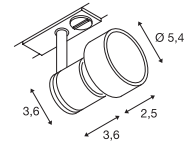

220-240V ~50/60Hz
Material: aluminium/polycarbonate (PC)



Base: 1xGU10

Options	Prod. no.
● black	143390
○ white	143391
● grey	143392



LED GU10 51mm | 6W | 38°
2700K | 450lm | EEK=F
6kWh/1000h



Prod. no.: 1005075

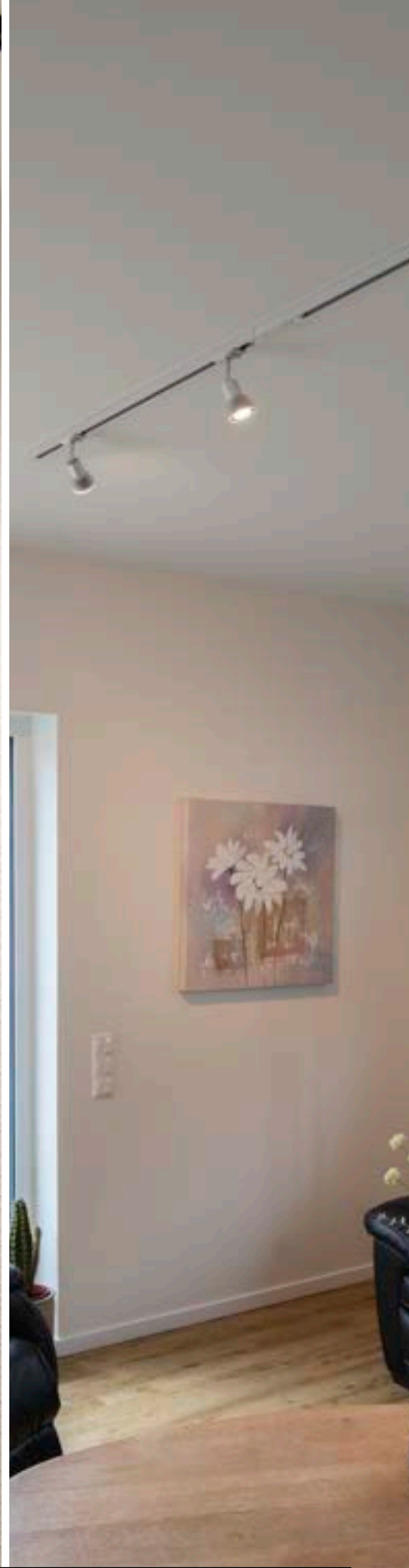

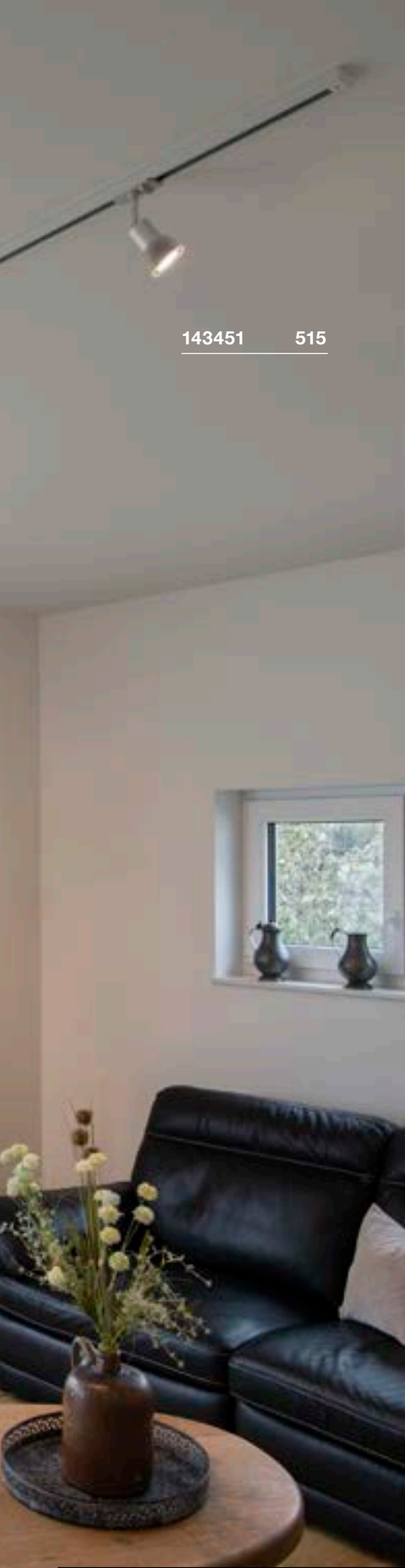

143451 515

PURIA TRACK 1 phase, QPAR51

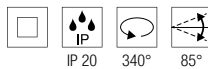
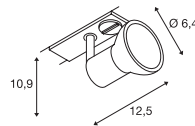

220-240V ~50/60Hz
Material: aluminium/plastic



Base: 1xGU10

Options	Prod. no.
● black	143450
○ white	143451
● grey	143454



LED GU10 51mm | 6W | 36°
2200-2700K | 360lm | EEK=G



Prod. no.: 1005273

AVO TRACK 1 phase, QPAR51

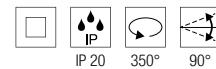
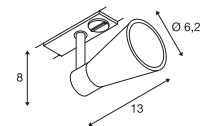

220-240V ~50/60Hz
Material: steel



Base: 1xGU10

Max. diameter: 5.1 cm

Options	Prod. no.
● black	144200
○ white	144201
● grey	144204



LED GU10 51mm | 6W | 38°
2700K | 450lm | EEK=F



Prod. no.: 1005077

ENOLA C TRACK

1 phase

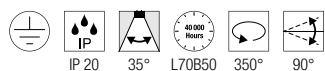
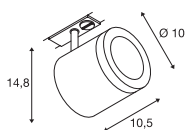

220-240V ~50/60Hz | 500mA
 Total wattage: 11W
 Material: aluminium/glass



Down 1040lm | 3000K

Options	Prod. no.
● black	1000711
○ white	143941

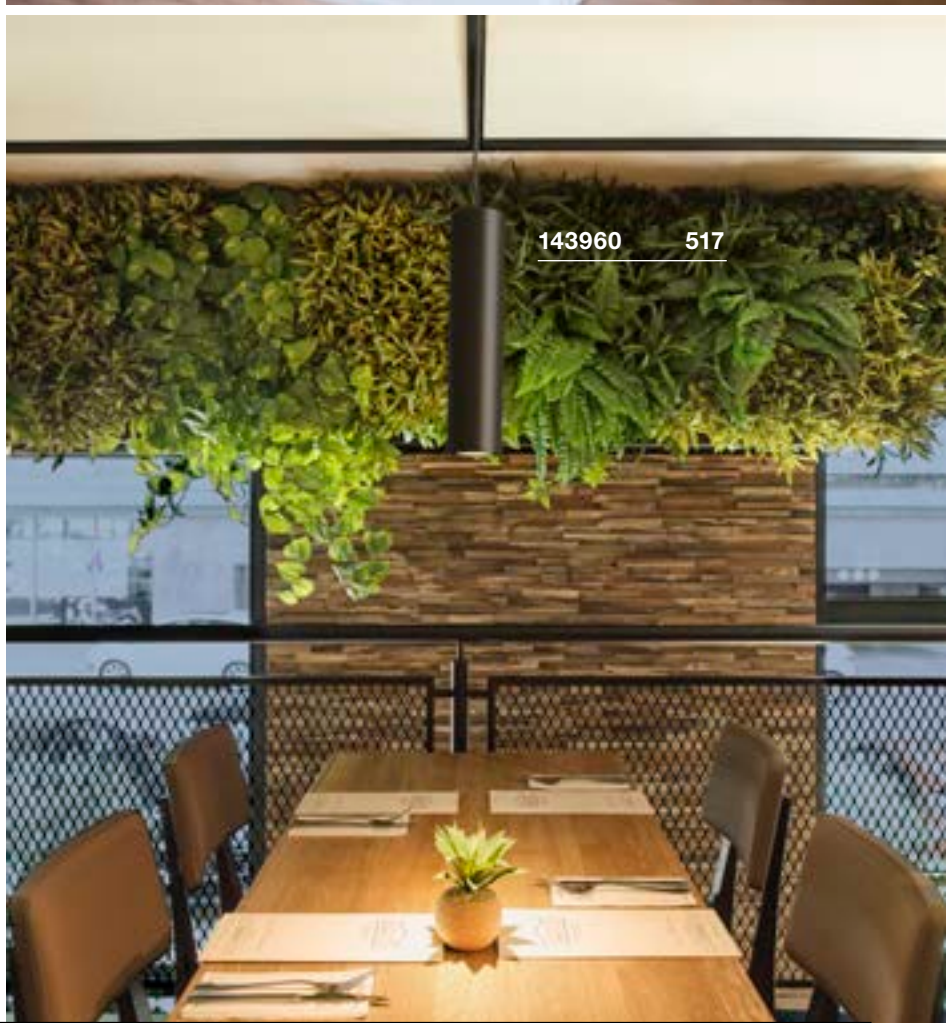



ENOLA C TRACK 1 phase

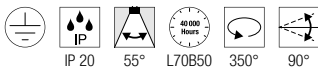
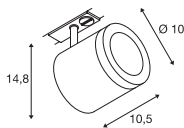

220-240V ~50/60Hz | 500mA
Total wattage: 11W
Material: aluminium/glass



Down 1040lm | 3000K

Options	Prod. no.
● black	1000712
○ white	143951

ENOLA B TRACK 1 phase, QPAR51

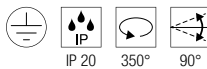
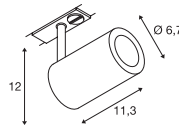

220-240V ~50/60Hz
Material: aluminium/steel



Base: 1xGU10 Max. diameter: 5.1 cm L: 6.7 cm

Options	Prod. no.
● black	1002110
○ white	1002111
● grey	1002113



LED GU10 51mm | 6W | 38°
2700K | 450lm | EEK=F
6kWh/1000h

Prod. no.: 1005075



ENOLA B PD, QPAR51

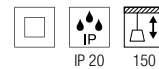
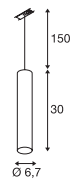

220-240V ~50/60Hz
Material: aluminium/steel



Base: 1xGU10

Options	Prod. no.
● black	143960
○ white	143961



LED GU10 51mm | 6W | 38°
2700K | 450lm | EEK=F
6kWh/1000h

Prod. no.: 1005077



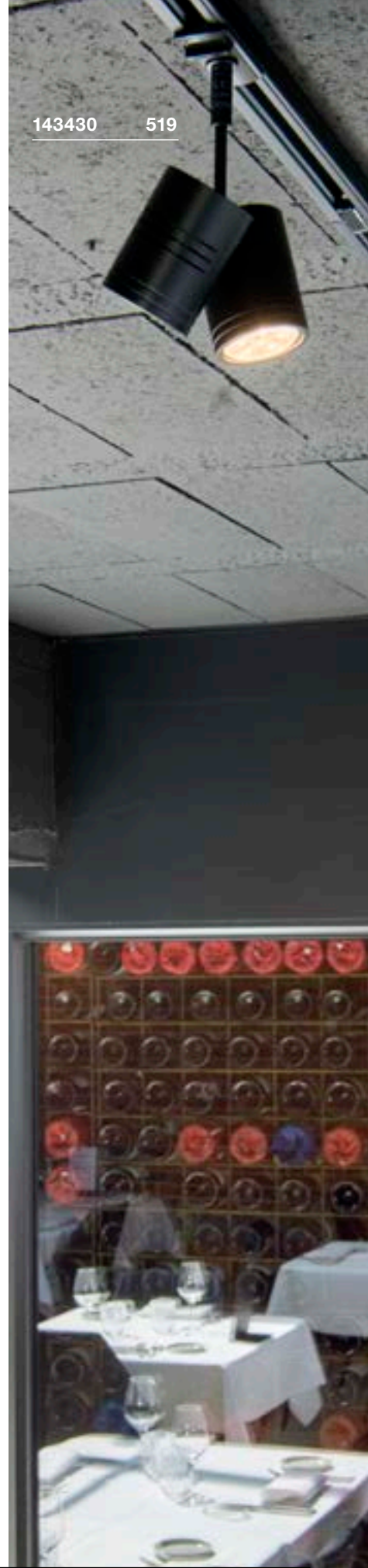



BIMA
1 phase, single, QPAR51

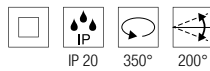
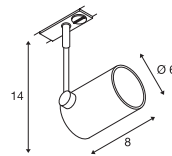

220-240V ~50/60Hz
Material: aluminium



Base: 1xGU10 Max. diameter: 5.1 cm | L: 5.7 cm

Options	Prod. no.
● black	143440
○ white	143441
● grey	143442



LED GU10 51mm | 6W | 38°
2700K | 450lm | EEK=F
6kWh/1000h



Prod. no.: 1005075

BIMA
1 phase, double, QPAR51

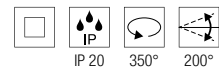
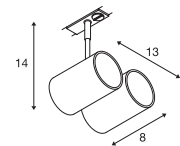

220-240V ~50/60Hz
Material: aluminium



Base: 2xGU10 Max. diameter: 5.1 cm | L: 5.7 cm

Options	Prod. no.
● black	143430
○ white	143431
● grey	143432



LED GU10 51mm | 6W | 38°
2700K | 450lm | EEK=F
6kWh/1000h



Prod. no.: 1005077

KALU TRACK
1 phase, PHASE

KALU TRACK
1 phase, QPAR111

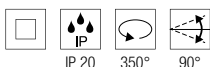
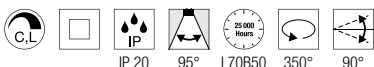
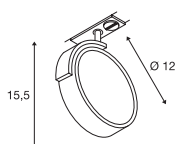
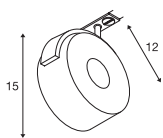

220-240V ~50/60Hz
Total wattage: 13W
Material: aluminium

220-240V ~50/60Hz
Material: aluminium/plastic



Down 970lm | 3000K



Base: 1xGU10

Options	Prod. no.
● black	1002854
○ white	143731

Options	Prod. no.
● black	143540
○ white	143541
● grey	143544



QPAR111 | 12.5W | 10°
3000K | 950lm | EEK=F
13kWh/1000h



Prod. no.: 1005278

1002854 520

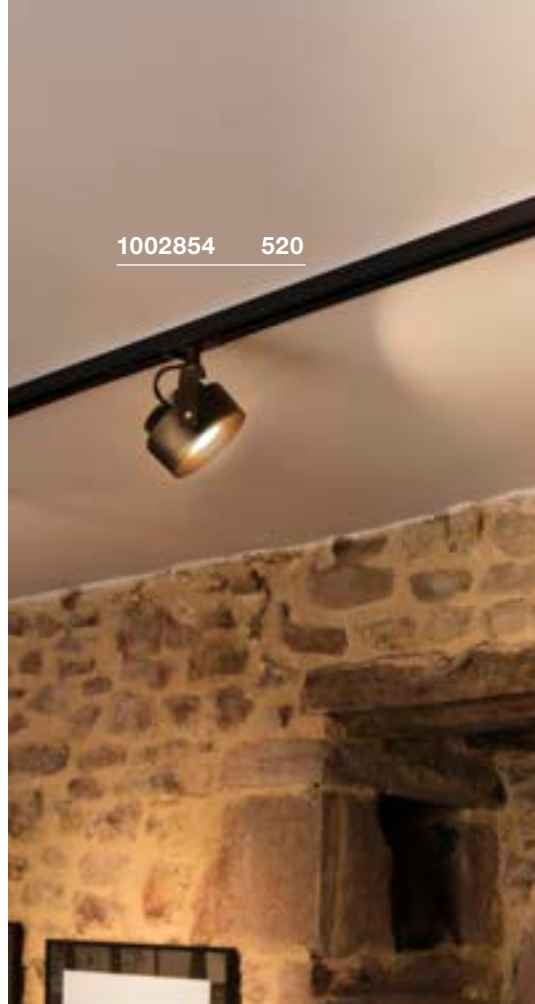

1001861 521





EURO SPOT TRACK
1 phase, QPAR51

ALTRA DICE TRACK
1 phase, QPAR51

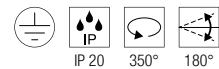
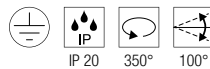
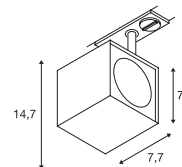
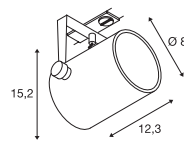

220-240V ~50/60Hz
Material: aluminium

220-240V ~50/60Hz
Material: aluminium

143350 521



Base: 1xGU10

Base: 1xGU10

Options	Prod. no.
● black	1001861
○ white	143811

Options	Prod. no.
● black	143350
○ white	143351
● grey	143354



LED GU10 51mm | 6W | 38°
2700K | 450lm | EEK=F
6kWh/1000h



Prod. no.: 1005077



LED GU10 51mm | 6W | 36°
2200-2700K | 360lm | EEK=G
6kWh/1000h



Prod. no.: 1005273



DESIGN YOUR HIGH-VOLTAGE TRACK SYSTEM

Professionally managed: well-designed lighting is essential, especially where there's plenty to see. Due to the versatility of track lighting, it's possible to showcase specific objects in the perfect light. Changes to the lighting design can also be made at any time. 3-phase high-voltage busbars are perfect for shops and exhibition stands. They create the perfect illumination and present products and exhibition items in just the right light. 1-phase high-voltage busbars are particularly suitable for private homes and bathe your living space in atmospheric light. Thanks to the boreholes present in their cross-section, these aluminium tracks can be attached to your ceiling quickly and easily. You can choose from a recessed version and a surface-mounted version, and both are available in multiple colours.

CHOOSE YOUR PREFERRED ...

- 1 track (S-TRACK, EUTRAC, 1-phase system)
- 2 Assembly type (recessed/mounting track)
- 3 Lights
- 4 Design options



DONE!

TRACK SYSTEMS

S-TRACK
3-phase system



EUTRAC
3-phase system



1-PHASE SYSTEM



Recessed track



Mounting track



Ceiling



Wall



Pendant

Mounting options

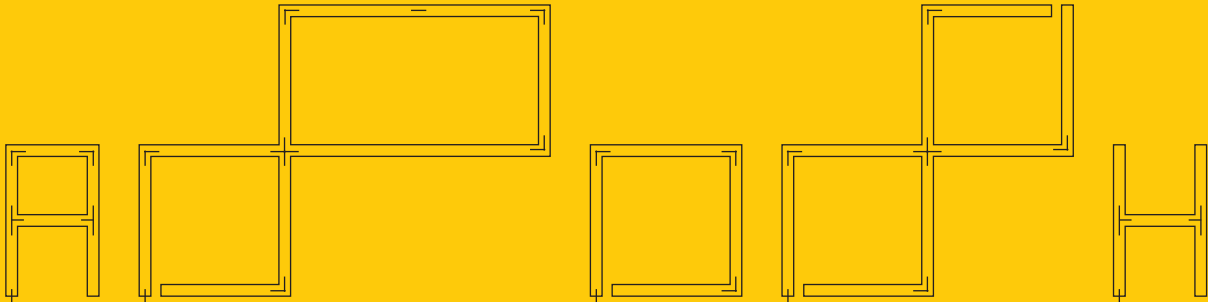

Various design options tailored to your room

Use our track configurator at slv.com



1006159 552



NUMINOS®
can be found
on family pages
110-115

LED



ONE®
can be found
on family pages
194-195

LED



NEW

TS V | 543



NEW

TS V | 543



NEW

NOBLO® SPOT | 545



NEW

NOBLO® SPOT | 545



NEW

NOBLO® SPOT | 547



NEW

NOBLO® SPOT | 547



NEW

SCKET
PANTILO
ROPE 19 | 549



LED
SIGHT TRACK | 550



LED
SIGHT TRACK | 550



LED
SIGHT MOVE | 551



LED
SIGHT MOVE | 551



SCKET
PARA CONE GL | 552



SCKET
PARA CONE GL | 552



SCKET
PARA CONE 14 | 553



SCKET
PARA CONE 14 | 553



SCKET
FORCHINI M 40
TRACK | 554



LED
EURO CUBE | 555



SCKET
EURO SPOT
TRACK | 555



SCKET
EURO SPOT
TRACK | 555



SCKET
ALTRA DICE
TRACK | 556



SCKET
PURI TRACK | 557



SCKET
PURI TRACK
GLASS | 557



LED
KALU TRACK
LED | 558



SCKET
KALU TRACK | 558



SCKET
BIMA | 559



SCKET
BIMA | 559



LED
HELIA 50 TRACK | 561





LED
ENOLA C TRACK | 561





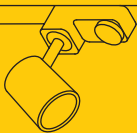
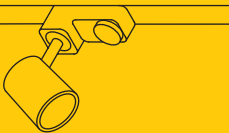

SCKET
AVO TRACK | 561

3-PHASE BUSBAR COMPATIBILITY

Compatible with lights/adapters from:

	SLV	Global/Nordic	EUTRAC®
DALI S-TRACK SLV tracks and track components 			
without DALI	✓	✓	★
with DALI	✓	✓	✗

Compatible with tracks and track components from:

	SLV S-TRACK	Global/Nordic	EUTRAC®
DALI S-TRACK SLV lights 			
without DALI	✓	✓	✓
with DALI	✓	✓	✓★★

★ Subject to prior testing using light and track samples
 ★★ But without DALI functionality

The SLV track systems and components are highly compatible.
 With lights and adapters from: EUTRAC®, Zumtobel, Erco, LTS ONETrack
 and unipro®. Subject to prior testing using light and track samples.

Zumtobel	Erco	LTS ONETrack	unipro®
			
✓	✓	✓	✓
✗	✗	✓	✓
Zumtobel	Erco	LTS ONETrack	unipro®
			
✓	✓	✓	✓
✗	✗	✓	✓

Details not guaranteed.
 Technical data and dimensions are subject to change without notice.
 During the planning phase of the project, check the project using samples to ensure functionality.
 Compatibility refers only to tracks/lights.
 Tracks and track components from different manufacturers should not be combined.





S-TRACK

3-phase DALI surface-mounted track

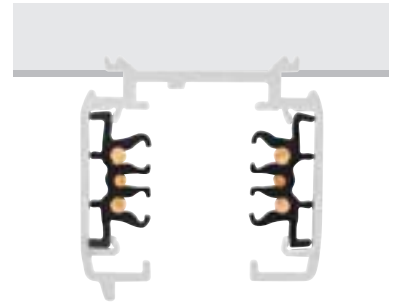

	1 m	1 m	2 m	2 m
Nominal voltage (V)	220-240V ~50/60Hz	220-240V ~50/60Hz	220-250V ~50/60Hz	220-250V ~50/60Hz
Max. current (A)	16	16	16	16
max. mech. load	30 kg	30 kg	30 kg	30 kg
Colour	● black	○ white	● black	○ white
Material	aluminium	aluminium	aluminium	aluminium
L x W x H (cm)	100 x 3.6 x 3.6	100 x 3.6 x 3.6	200 x 3.6 x 3.6	200 x 3.6 x 3.6
Prod. no.	1004937	1004938	1002631	1002632

	3 m	3 m	4 m	4 m
Nominal voltage (V)	220-250V ~50/60Hz	220-250V ~50/60Hz	220-250V ~50/60Hz	220-250V ~50/60Hz
Max. current (A)	16	16	16	16
max. mech. load	30 kg	30 kg	30 kg	30 kg
Colour	● black	○ white	● black	○ white
Material	aluminium	aluminium	aluminium	aluminium
L x W x H (cm)	300 x 3.6 x 3.6	300 x 3.6 x 3.6	400 x 3.6 x 3.6	400 x 3.6 x 3.6
Prod. no.	1002633	1002634	1002635	1002636

S-TRACK

3-phase DALI surface-mounted track
 Planning assistance and accessories at a glance

View of components from above on
 the installation side

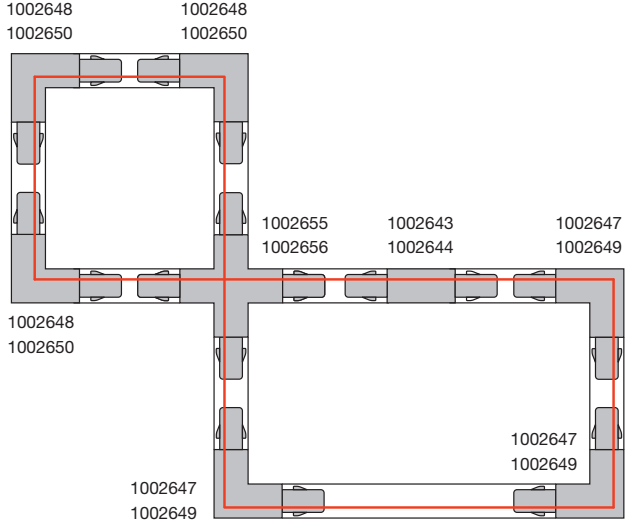
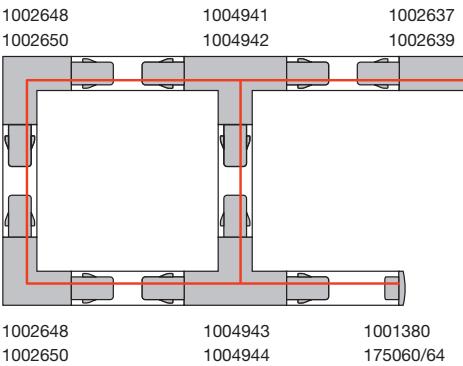
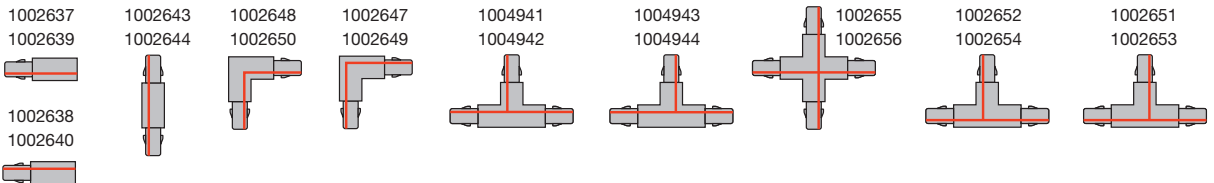
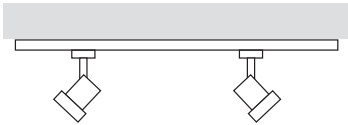

Feeder, DALI, earth left
 16A max. | Polycarbonate (PC) / Polycarbonate (PC)
 L: 13.9 cm | W: 3.5 cm | H: 3.3 cm

● black Prod. no. **1002637**
 ○ white **1002639**

Feed-in, Dali, earth right
 16 A max. | polycarbonate (PC)
 L: 13.9 cm | W: 3.5 cm | H: 3.3 cm

● black Prod. no. **1002638**
 ○ white **1002640**

L-connector, DALI, earth outside*
 16 A max. | polycarbonate (PC)
 L: 11.9 cm | W: 11.9 cm | H: 3.3 cm

● black Prod. no. **1002647**
 ○ white **1002649**

L-connector, DALI, earth inside*
 16 A max. | polycarbonate (PC)
 L: 11.9 cm | W: 11.9 cm | H: 3.3 cm

● black Prod. no. **1002648**
 ○ white **1002650**

**T-connector, DALI, earth external, left***

16 A max. | polycarbonate (PC)
L: 20.3 cm | W: 11.9 cm | H: 3.3 cm

- black Prod. no. **1002652**
- white Prod. no. **1002654**

**3 phase Adapter, DALI**

10 A max. | Polycarbonate (PC)
L: 11.3 cm | W: 5.5 cm | H: 3.3 cm

- black Prod. no. **1002660**
- white Prod. no. **1002659**

**T-connector, DALI, earth external, right***

16 A max. | polycarbonate (PC)
L: 20.3 cm | W: 11.9 cm | H: 3.3 cm

- black Prod. no. **1002651**
- white Prod. no. **1002653**

**Mech. 3 phase Adapter**

Aluminium / plastic
L: 6.6 cm | W: 6.6 cm | H: 3.1 cm

- black Prod. no. **175210**
- white Prod. no. **1001395**

**T-connector, DALI, earth internal left***

16 A max. | polycarbonate (PC)
L: 20.3 cm | W: 11.9 cm | H: 3.3 cm

- black Prod. no. **1004941**
- white Prod. no. **1004942**

**Cover, 2m**

Polycarbonate (PC)
L: 200 cm | W: 2.2 cm | H: 0.75 cm

- black Prod. no. **1004939**
- white Prod. no. **1004940**

**T-connector, DALI, earth internal right***

16 A max. | polycarbonate (PC)
L: 20.3 cm | W: 11.9 cm | H: 3.3 cm

- black Prod. no. **1004943**
- white Prod. no. **1004944**

**End cap**

plastic
L: 3.5 cm | W: 3.3 cm | H: 3.2 cm

- black Prod. no. **175060**
- white Prod. no. **1001380**

**X-connector, DALI***

16A max. | Polycarbonate (PC) / Polycarbonate (PC)
L: 20.3 cm | W: 20.3 cm | H: 3.3 cm

- black Prod. no. **1002655**
- white Prod. no. **1002656**

**Pendant suspension**

Aluminium / plastic
L: 6 cm | W: 6 cm | H: 4 cm
max. mechanical load: 10 kg

- black Prod. no. **175160**
- white Prod. no. **1001390**

**Longitudinal connector, DALI***

16 A max. | polycarbonate (PC)
L: 20.3 cm | W: 3.5 cm | H: 3.3 cm

- black Prod. no. **1002643**
- white Prod. no. **1002644**

**Joint connector**

aluminium
L: 18.2 cm | W: 3.3 cm | H: 2.1 cm

- black Prod. no. **175180**
- white Prod. no. **1001392**

**Mini-connector, DALI**

16 A max. | polycarbonate (PC)
L: 10.6 cm | W: 2.5 cm | H: 2.8 cm

- black Prod. no. **1002641**
- white Prod. no. **1002642**

**Mech. 3 phase Adaptor with hook**

Plastic/steel
H: 5.2 cm
max. mechanical load: 10 kg

- black Prod. no. **175190**
- white Prod. no. **1001393**

**Flex connector, DALI**

16 A max. | polycarbonate (PC)
L: 28.5 cm | W: 3.5 cm | H: 3.3 cm

- black Prod. no. **1002645**
- white Prod. no. **1002646**

**Ceiling rosette, DALI**

16 A max. | polycarbonate (PC)
H: 3.5 cm Diameter: 14.3 cm

- black Prod. no. **1004684**
- white Prod. no. **1004685**

**Insulating connector**

plastic
L: 6.8 cm | W: 3.1 cm | H: 2.6 cm

- black Prod. no. **175080**
- white Prod. no. **1001382**

**Wire rope suspension (2 pieces)**

Stainless steel/brass
L: 500cm
max. mechanical load: 10 kg

- nickel Prod. no. **1002845**

**Pendant clip, DALI**

Steel
L: 4 cm | W: 3.4 cm | H: 1.25 cm

- black Prod. no. **1002657**
- white Prod. no. **1002658**

* with feed capacity





S-TRACK

DALI 3-phase recessed track



	1 m	1 m	2 m	2 m
Nominal voltage (V)	220-250V ~50/60Hz	220-250V ~50/60Hz	220-250V ~50/60Hz	220-250V ~50/60Hz
Max. current (A)	16	16	16	16
max. mech. load	30 kg	30 kg	30 kg	30 kg
Colour	● black	○ white	● black	○ white
Material	aluminium	aluminium	aluminium	aluminium
L x W x H (cm)	100 x 5.6 x 3.2	100 x 5.6 x 3.2	200 x 5.6 x 3.2	200 x 5.6 x 3.2
Prod. no.	1006511 ●	1006512 ●	1006513 ●	1006514 ●

	3 m	3 m	4 m	4 m
Nominal voltage (V)	220-250V ~50/60Hz	220-250V ~50/60Hz	220-250V ~50/60Hz	220-250V ~50/60Hz
Max. current (A)	16	16	16	16
max. mech. load	30 kg	30 kg	30 kg	30 kg
Colour	● black	○ white	● black	○ white
Material	aluminium	aluminium	aluminium	aluminium
L x W x H (cm)	300 x 5.6 x 3.2	300 x 5.6 x 3.2	400 x 5.6 x 3.2	400 x 5.6 x 3.2
Prod. no.	1006515 ●	1006516 ●	1006517 ●	1006518 ●



S-TRACK

DALI 3-phase recessed track
Planning assistance and accessories at a glance

View of components from above on
the installation side

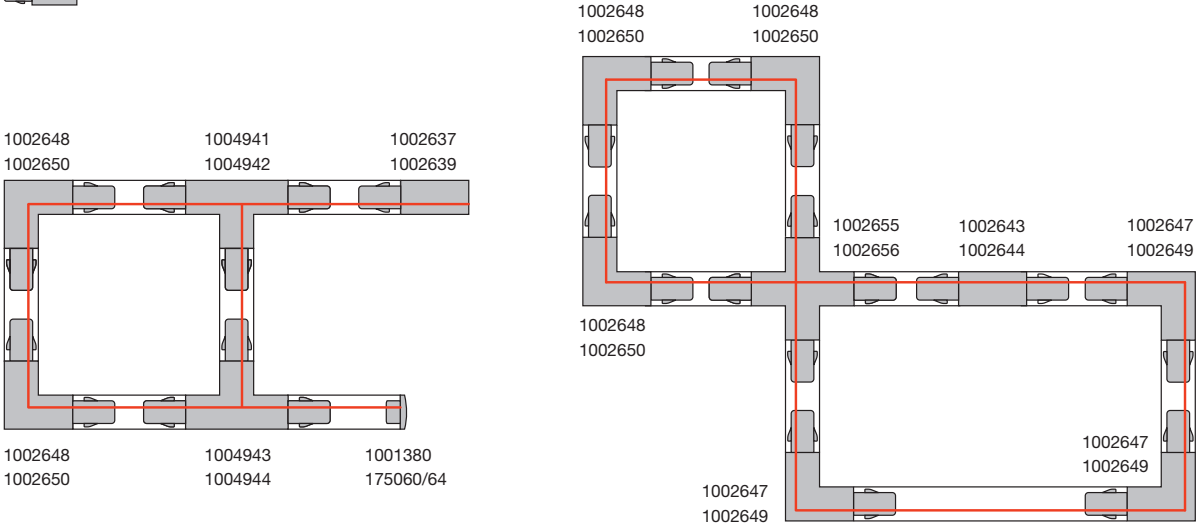
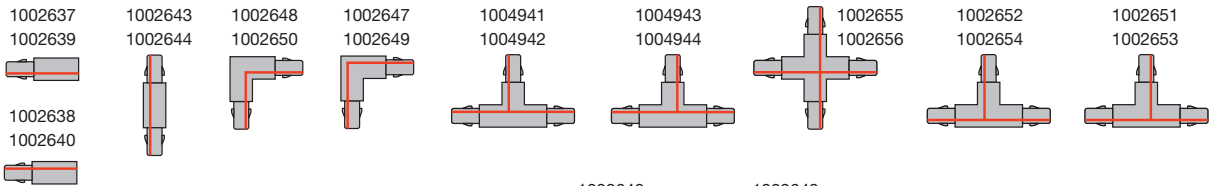
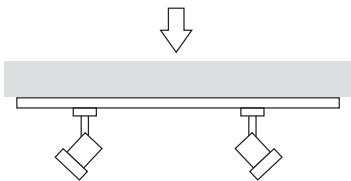



Feeder, DALI, earth right
16 A max. | polycarbonate (PC)
L: 14.7 cm | W: 5.6 cm | H: 3.3 cm

● black Prod. no. **1006519**
○ white **1006520**



T-connector, DALI, earth external, right*
16 A max. | polycarbonate (PC)
L: 20.3 cm | W: 13 cm | H: 3.3 cm

● black Prod. no. **1006533**
○ white **1006534**



Feeder, DALI, earth left
16 A max. | polycarbonate (PC)
L: 14.7 cm | W: 5.6 cm | H: 3.3 cm

● black Prod. no. **1006521**
○ white **1006522**



T-connector, DALI, earth internal left*
16 A max. | polycarbonate (PC)
L: 20.3 cm | W: 13 cm | H: 3.3 cm

● black Prod. no. **1006527**
○ white **1006528**



L-connector, DALI, earth outside*
16 A max. | polycarbonate (PC)
L: 13 cm | W: 13 cm | H: 3.3 cm

● black Prod. no. **1006525**
○ white **1006526**



X-connector, DALI*
16 A max. | polycarbonate (PC)
L: 20.3 cm | W: 20.3 cm | H: 3.3 cm

● black Prod. no. **1006535**
○ white **1006536**



L-connector, DALI, earth inside*
16 A max. | polycarbonate (PC)
L: 13 cm | W: 13 cm | H: 3.3 cm

● black Prod. no. **1006523**
○ white **1006524**



Longitudinal connector, DALI*
16 A max. | polycarbonate (PC)
L: 20.3 cm | W: 5.6 cm | H: 3.3 cm

● black Prod. no. **1006537**
○ white **1006538**



T-connector, DALI, earth external, left*
16 A max. | polycarbonate (PC)
L: 20.3 cm | W: 13 cm | H: 3.3 cm

● black Prod. no. **1006529**
○ white **1006530**



Mini-connector, DALI
16 A max. | polycarbonate (PC)
L: 10.6 cm | W: 2.5 cm | H: 2.8 cm

● black Prod. no. **1002641**
○ white **1002642**



T-connector, DALI, earth internal right*
16 A max. | polycarbonate (PC)
L: 20.3 cm | W: 13 cm | H: 3.3 cm

● black Prod. no. **1006531**
○ white **1006532**



End cap, DALI
Polycarbonate (PC)
L: 4.79 cm | W: 5.6 cm

● black Prod. no. **1006539**
○ white **1006540**

* with feed capacity





EUTRAC®

3-phase surface-mounted track

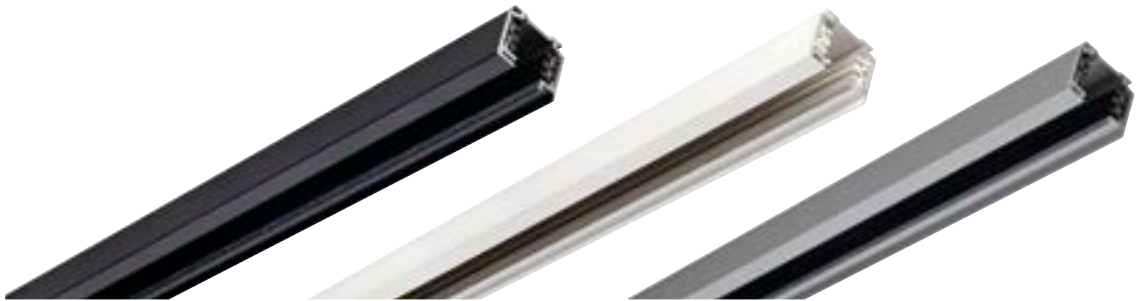
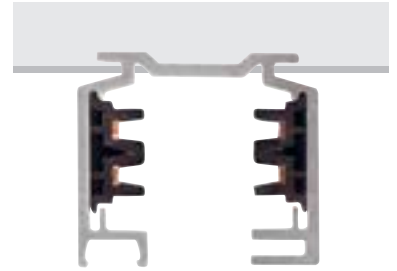

	1 m	1 m	1 m
Nominal voltage (V)	220-240V ~50/60Hz	220-240V ~50/60Hz	220-240V ~50/60Hz
Max. current (A)	16	16	16
Colour	● black	○ white	● grey
Material	Aluminium / plastic	Aluminium / plastic	Aluminium / plastic
L x W x H (cm)	100 x 3.6 x 3.2	100 x 3.6 x 3.2	100 x 3.6 x 3.2
Prod. no.	145100	1001510	145102

	2 m	2 m	2 m
Nominal voltage (V)	220-240V ~50/60Hz	220-240V ~50/60Hz	220-240V ~50/60Hz
Max. current (A)	16	16	16
Colour	● black	○ white	● grey
Material	Aluminium / plastic	Aluminium / plastic	Aluminium / plastic
L x W x H (cm)	200 x 3.6 x 3.2	200 x 3.6 x 3.2	200 x 3.6 x 3.2
Prod. no.	145200	1001511	145202

	3 m	3 m	3 m
Nominal voltage (V)	220-240V ~50/60Hz	220-240V ~50/60Hz	220-240V ~50/60Hz
Max. current (A)	16	16	16
Colour	● black	○ white	● grey
Material	Aluminium / plastic	Aluminium / plastic	Aluminium / plastic
L x W x H (cm)	300 x 3.6 x 3.2	300 x 3.6 x 3.2	300 x 3.6 x 3.2
Prod. no.	145300	1001512	145302

EUTRAC®

3-phase surface-mounted track Planning assistance and accessories at a glance

View of components from above on
the installation side

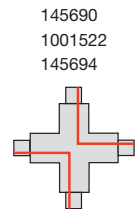
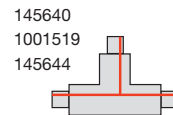
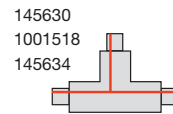
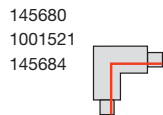
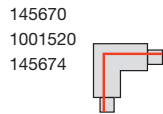
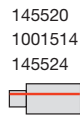
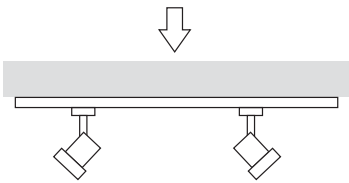

Example: earth external

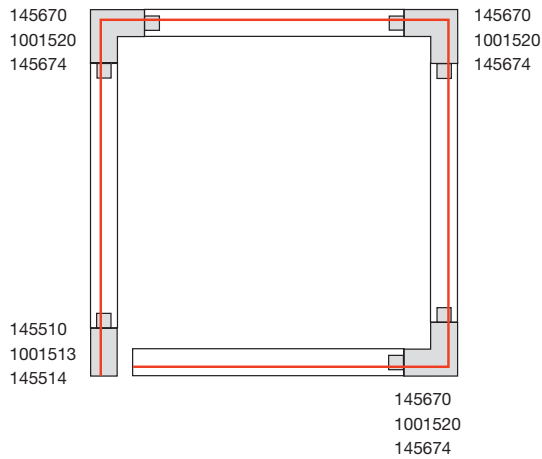

Example: earth internal

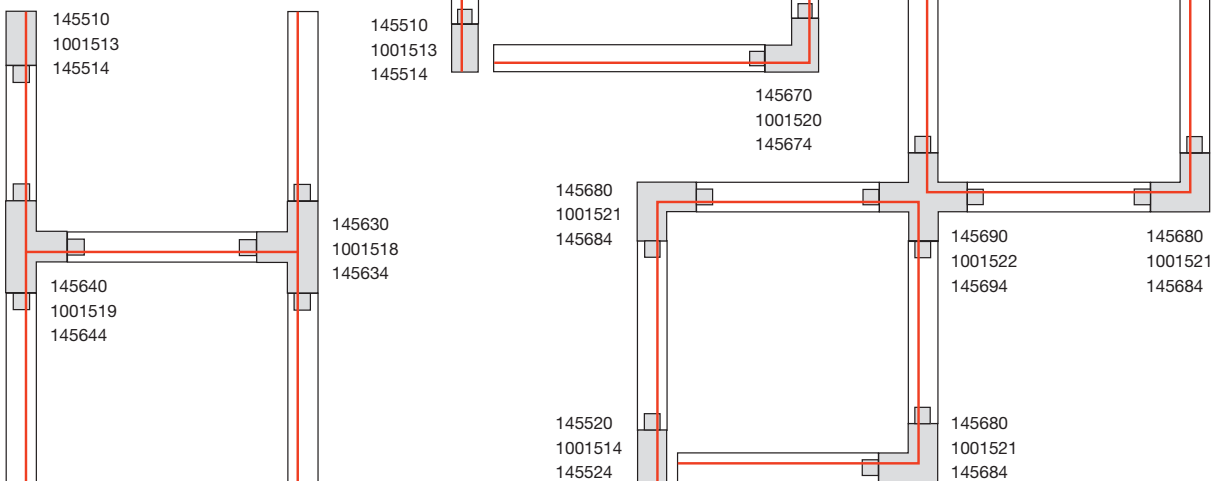

**Feed-in, earth left**

16 A max. | Plastic
L: 11.2 cm | W: 3.6 cm | H: 3.2 cm

- black Prod. no. **145510**
- white **1001513**
- grey **145514**

**Joint connector**

plastic
L: 10 cm | W: 3.6 cm | H: 1.9 cm

- black Prod. no. **145600**
- white **1001523**
- grey **145604**

**Feed-in, earth right**

16 A max. | Plastic
L: 11.2 cm | W: 3.6 cm | H: 3.2 cm

- black Prod. no. **145520**
- white **1001514**
- grey **145524**

**Flex connector**

16 A max. | Plastic
L: 30.7 cm | W: 3.6 cm | H: 3.2 cm

- black Prod. no. **145580**
- white **1001524**
- grey **145584**

**Central feed**

16 A max. | Plastic
L: 13 cm | W: 3.6 cm | H: 3.6 cm

- black Prod. no. **145530**
- white **1001515**
- grey **145534**

**Socket**

6.3A max. | Plastic
L: 9.6 cm | W: 6.5 cm | H: 9 cm

- black Prod. no. **145700**
- white **1001525**

**Longitudinal connector***

16 A max. | Plastic
L: 19.2 cm | W: 3.6 cm | H: 3.2 cm

- black Prod. no. **145660**
- white **1001517**
- grey **145664**

**3-phase**

10A max. | Plastic
L: 9.6 cm | W: 3.5 cm | H: 4.5 cm

- Max. mechanical load 20N.: 5 kg
- black Prod. no. **145990**
 - white **1001542**
 - grey **145994**

**Longitudinal connector***

16 A max. | Plastic
L: 5.8 cm | W: 1.5 cm | H: 2.6 cm

- black Prod. no. **145560**
- white **1001516**
- grey **145564**

**Pendant clip**

aluminium
L: 5 cm | W: 3.6 cm | H: 1.9 cm

- black Prod. no. **145730**
- white **1001530**
- grey **145734**

**L-connector, earth internal***

16 A max. | Plastic
L: 15 cm | W: 15 cm | H: 3.2 cm

- black Prod. no. **145680**
- white **1001521**
- grey **145684**

**Universal point outlet**

16 A max. | Plastic
H: 3.1 cm Diameter: 11.9 cm

- black Prod. no. **145830**
- white **1001526**
- grey **145834**

**L-connector, earth external***

16 A max. | Plastic
L: 15 cm | W: 15 cm | H: 3.2 cm

- black Prod. no. **145670**
- white **1001520**
- grey **145674**

**End cap**

plastic
L: 3.6 cm | W: 1.7 cm | H: 3.2 cm

- black Prod. no. **145590**
- white **1001527**
- grey **145594**

**T-connector, earth internal left***

16 A max. | Plastic
L: 26 cm | W: 18.5 cm | H: 3.2 cm

- black Prod. no. **145630**
- white **1001518**
- grey **145634**

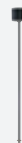
**Pendant suspension, rigid**

Plastic/steel
L: 60 cm | H: 63.5 cm Diameter: 7 cm

- black Prod. no. **145720**
- white **1001529**
- grey **145724**

**T-connector, earth internal right***

16 A max. | Plastic
L: 26 cm | W: 18.5 cm | H: 3.2 cm

- black Prod. no. **145640**
- white **1001519**
- grey **145644**

**Pendant suspension, rigid**

Plastic/steel
H: 122 cm Diameter: 7 cm

- black Prod. no. **145710**
- white **1001528**
- grey **145714**

**X connector***

16 A max. | Plastic
L: 26 cm | W: 26 cm | H: 3.2 cm

- black Prod. no. **145690**
- white **1001522**
- grey **145694**

**Wire rope suspension (2 pieces)**

Stainless steel/brass
L: 500cm
max. mechanical load: 10 kg

- nickel Prod. no. **1002845**

* with feed capacity





EUTRAC®

3-phase recessed track with matching accessories

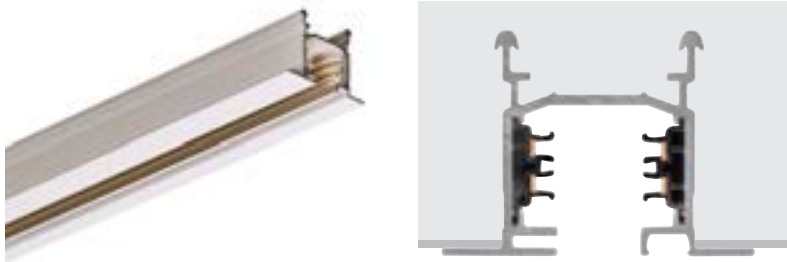

	2 m	3 m
Nominal voltage (V)	220-240V ~50/60Hz	220-240V ~50/60Hz
Max. current (A)	16	16
Colour	<input type="radio"/> white	<input type="radio"/> white
Material	Aluminium / plastic	Aluminium / plastic
L x W x H (cm)	200 x 5.9 x 4.1	300 x 5.9 x 4.1
Prod. no.	1001531	1001532

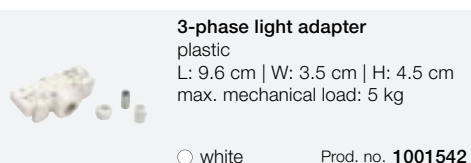
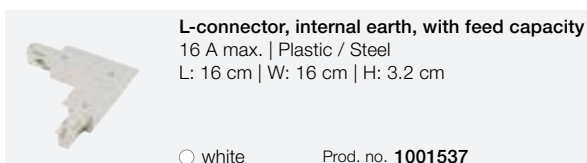
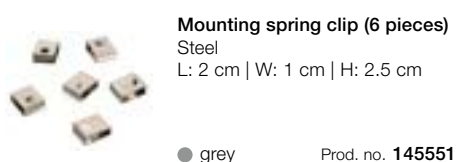
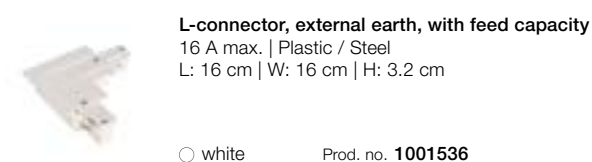
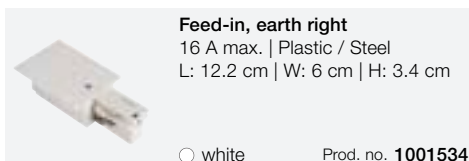
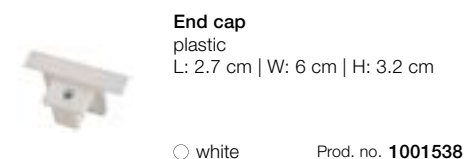
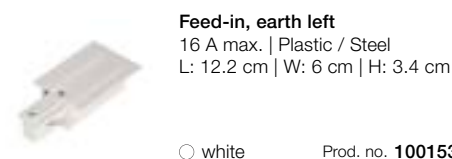

1007655 543





TS V
3-phase

TS V
3-phase

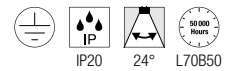
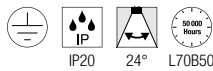
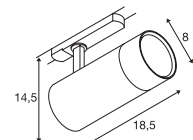
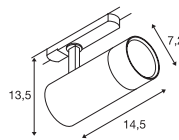

220-240V ~50/60Hz | 250/350/500mA
Total wattage: 20W
Material: aluminium/polycarbonate (PC)

220-240V ~50/60Hz | 600/750/mA
Total wattage: 35W
Material: aluminium/polycarbonate (PC)



Down	1800lm	2700K
	1980lm	3000K
	1920lm	4000K

Down	3090lm	2700K
	3470lm	3000K
	3300lm	4000K

Options	Prod. no.
● black	1007655 ●
○ white	1007654 ●

Options	Prod. no.
● black	1007657 ●
○ white	1007656 ●



1007646 545





NOBLO® SPOT
3-phase, PHASE

NOBLO® SPOT
3-phase, PHASE

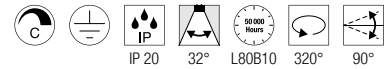
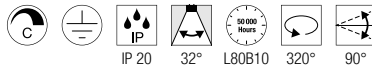
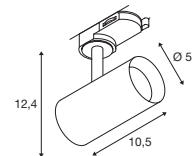
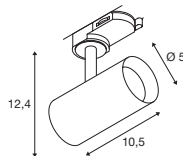

220-240V ~50/60Hz | 150mA
Total wattage: 6.2W
Material: aluminium/polycarbonate (PC)

220-240V ~50/60Hz | 150mA
Total wattage: 6.2W
Material: aluminium/polycarbonate (PC)



Down 740lm | 2700K

Down 750lm | 3000K

Options	Prod. no.
● black	1007644
○ white	1007645

Options	Prod. no.
● black	1007646
○ white	1007647

1007649 547





NOBLO® SPOT
3-phase, PHASE



NOBLO® SPOT
3-phase, PHASE

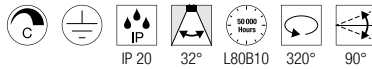
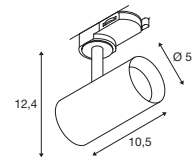
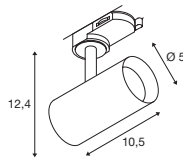

220-240V ~50/60Hz | 150mA
Total wattage: 6.2W
Material: aluminium/polycarbonate (PC)

220-240V ~50/60Hz | 350mA
Total wattage: 8.4W
Material: aluminium/polycarbonate (PC)



Down 760lm | 4000K



Down 30lm | 2000K - 450lm | 3000K

Options	Prod. no.
● black	1007648
○ white	1007649

Options	Prod. no.
● black	1007355
○ white	1007356

1007597 549

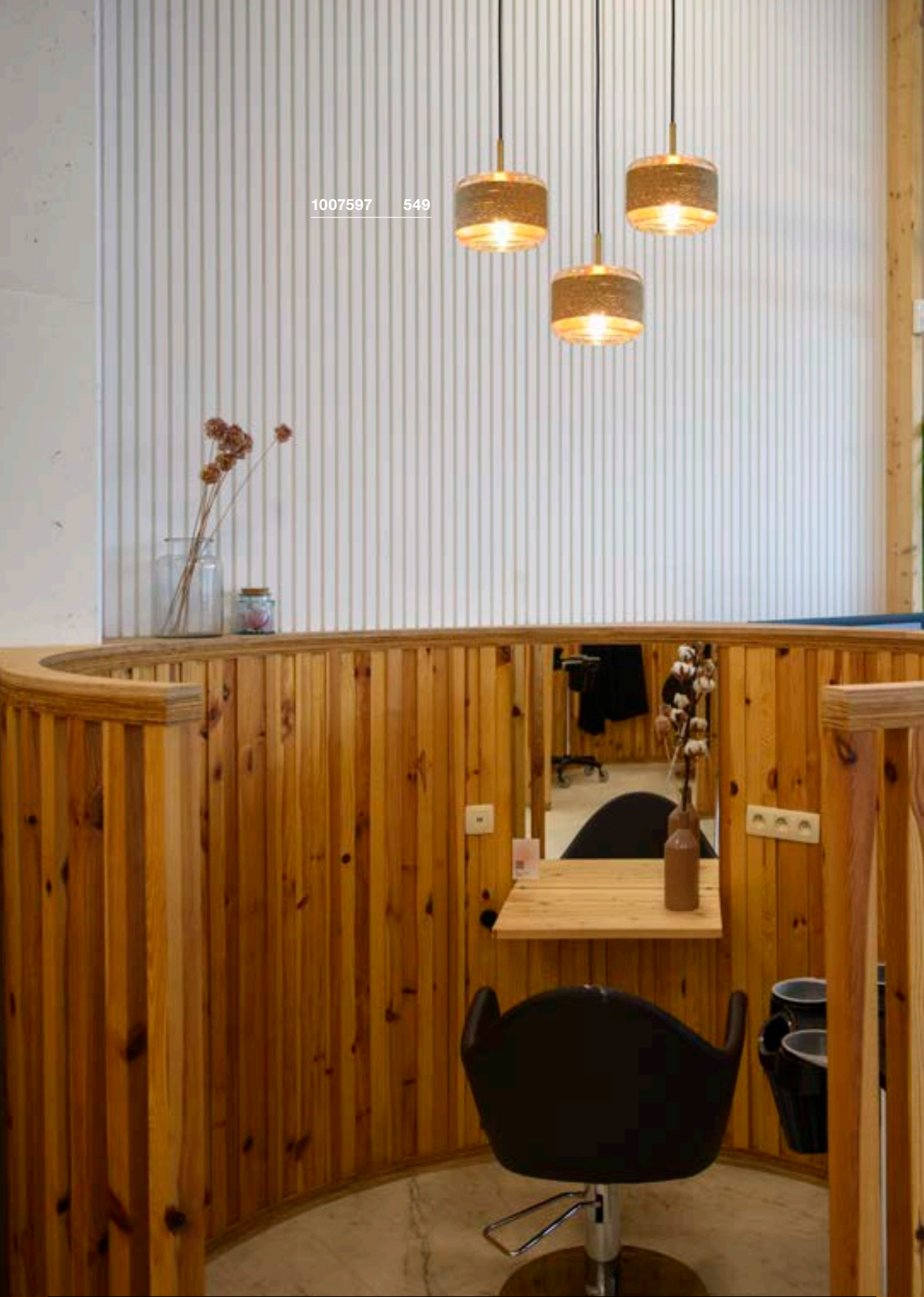



PANTILO ROPE 19

PD, E27

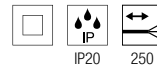
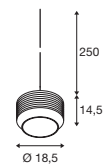
NEW

200-240V ~50/60Hz
Material: glass/steel/hemp

- Open cable end

SECRET **INSIDE** <15
W

Base: 1xE27

Max. diameter: 10 cm

L: 11 cm

Options	Prod. no.
● amber/gold	1007597 ●
● anthracite/silver	1007596 ●



A60 | 7.5W | 180°
2700K | 720lm | EEK=F
8kWh/1000h



Prod. no.: 1005305

SIGHT TRACK
3-phase, DALI

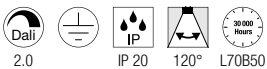
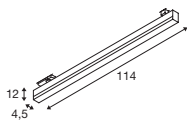

220-240V ~50/60Hz | 700mA
Total wattage: 39W
Material: aluminium/acrylic



Down 3000lm | 3000K | 3000lm | 4000K

Options	Prod. no.
● black	1005397
○ white	1005399

SIGHT TRACK
3-phase

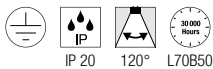
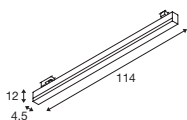

220-240V ~50/60Hz | 700mA
Total wattage: 37W
Material: aluminium/acrylic



Down 3000lm | 3000K | 3000lm | 4000K

Options	Prod. no.
● black	1005400
○ white	1005401
● grey	1005402

1005400 550





1005399 551

SIGHT MOVE 3-phase, DALI

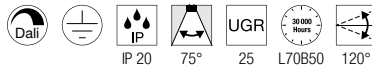
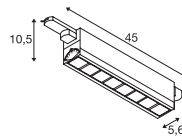

220-240V ~50/60Hz | 350mA
Total wattage: 26W
Material: aluminium/
polymethylacrylate (PMMA)



Down 2700lm | 3000K
3100lm | 4000K

Options	Prod. no.
● black 2700lm 3000K	1004690
○ white 2700lm 3000K	1004691
● black 3100lm 4000K	1004692
○ white 3100lm 4000K	1004693

SIGHT MOVE 3-phase

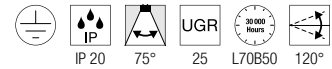
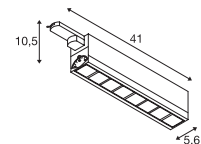

220-240V ~50/60Hz | 350mA
Total wattage: 26W
Material: aluminium/
polymethylacrylate (PMMA)



Down 2700lm | 3000K
3100lm | 4000K

Options	Prod. no.
● black 2700lm 3000K	1004686
○ white 2700lm 3000K	1004687
● black 3100lm 4000K	1004688
○ white 3100lm 4000K	1004689

PARA CONE GL
3-phase, GU10

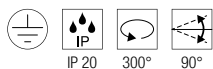
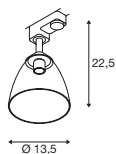

220-240V ~50/60Hz
Material: aluminium/glass



Base: 1xGU10

Options	Prod. no.
● black	1006157
○ white	1006158



LED GU10 51mm | 3.2W
2700K | 270lm | EEK=G



Prod. no.: 1006321

PARA CONE GL
PD, GU10

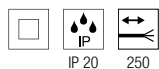
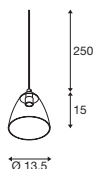

220-240V ~50/60Hz
Material: aluminium/glass

- Open cable end



Base: 1xGU10

Options	Prod. no.
● black	1006159
○ white	1006160



LED GU10 51mm | 3.2W
2700K | 270lm | EEK=G



Prod. no.: 1006321

1006157 552

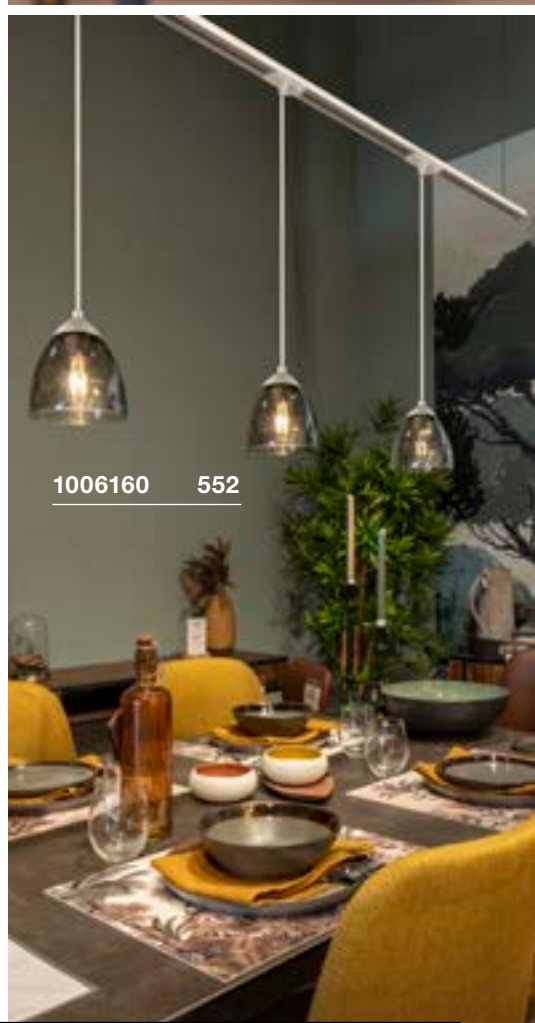

1006160 552



PARA CONE 14
3-phase, QPAR51

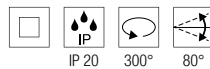
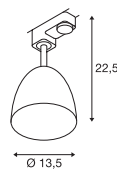

220-240V ~50/60Hz
Material: steel



Base: 1xGU10

Options	Prod. no.
● black	1002876
○ white	1002877
● copper	1002878



LED GU10 51mm | 3.2W
2700K | 270lm | EEK=G



Prod. no.: 1006321

PARA CONE 14
3-phase, PD, QPAR51

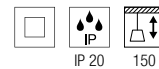
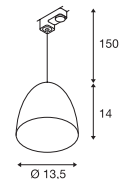

220-240V ~50/60Hz
Material: aluminium



Base: 1xGU10

Options	Prod. no.
● black	153140
○ white	153141
● copper	1002686



LED GU10 51mm | 3.2W
2700K | 270lm | EEK=G



Prod. no.: 1006321

153141 553

FORCHINI M 40 TRACK
3-phase, PD, E27

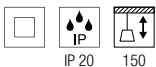
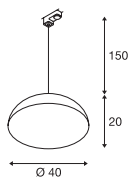

IP 20 150

220-240V ~50/60Hz
Material: aluminium/steel



Base: 1xE27 Max. diameter: 6.8 cm L: 15.2 cm

Options

Prod. no.

● black/gold

153130



A60 | 7.5W | 180°
2700K | 720lm | EEK=F
8kWh/1000h



Prod. no.: 1005305

153130

554



152750

555





EURO CUBE
3-phase

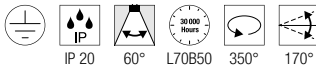
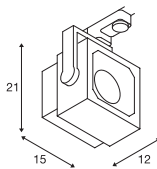

220-240V ~50/60Hz
Total wattage: 26W
Material: aluminium



Down 2470lm | 3000K
2740lm | 4000K

Options	Prod. no.
● black 2470lm 3000K	152750
○ white 2470lm 3000K	152751
● black 2740lm 4000K	152780
○ white 2740lm 4000K	152781

EURO SPOT TRACK
3-phase, QPAR111

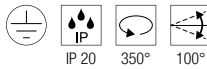
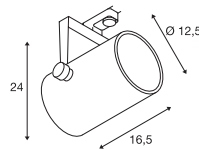

220-240V ~50/60Hz
Material: aluminium



Base: 1xGU10

Options	Prod. no.
● black	153420
○ white	153421



QPAR111 | 12.5W | 30°
2700K | 950lm | EEK=F
13kWh/1000h

Prod. no.: 1005276



EURO SPOT TRACK
3-phase, QPAR51

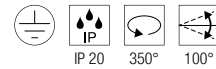
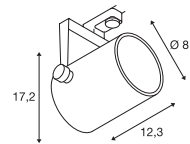

220-240V ~50/60Hz
Material: aluminium



Base: 1xGU10

Options	Prod. no.
● black	153850
○ white	153851



LED GU10 51mm | 6W | 38°
2700K | 450lm | EEK=F
6kWh/1000h

Prod. no.: 1005077



ALTRA DICE TRACK
3-phase, QPAR51

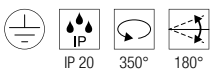
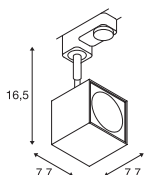

220-240V ~50/60Hz
Material: aluminium



Base: 1xGU10 Max. diameter: 5.1 cm L: 5.7 cm

Options	Prod. no.
● black	152320
○ white	152321

LED GU10 51mm | 6W | 36°
2200-2700K | 360lm | EEK=G



Prod. no.: 1005273

152320 556





153560 557

PURI TRACK
3-phase, QPAR51

PURI TRACK GLASS
3-phase, QPAR51

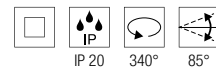
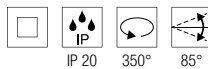
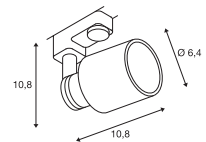
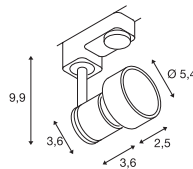

220-240V ~50/60Hz
Material: aluminium/polycarbonate (PC)

220-240V ~50/60Hz
Material: aluminium/plastic

- Decorative ring included



Base: 1xGU10

Base: 1xGU10

Options	Prod. no.
● black	153560
○ white	153561
● grey	153564

Options	Prod. no.
● black	1001871
○ white	1001872



LED GU10 51mm | 6W | 38°
2700K | 450lm | EEK=F
6kWh/1000h



Prod. no.: 1005075



LED GU10 51mm | 6W | 38°
2700K | 450lm | EEK=F
6kWh/1000h



Prod. no.: 1005077

KALU TRACK LED
3-phase, PHASE

KALU TRACK
3-phase, QPAR111

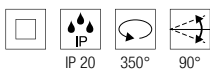
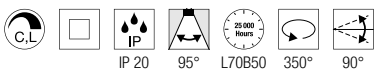
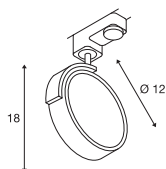
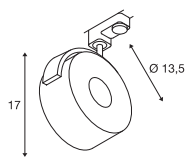

220-240V ~50/60Hz
Total wattage: 13W
Material: aluminium

220-240V ~50/60Hz
Material: aluminium/plastic



Down 970lm | 3000K



Base: 1xGU10

Options	Prod. no.
● black CRI80	152600
○ white CRI90	152601

Options	Prod. no.
● black	152610
○ white	152611



QPAR111 | 12.5W | 10°
3000K | 950lm | EEK=F
13kWh/1000h

Prod. no.: 1005278

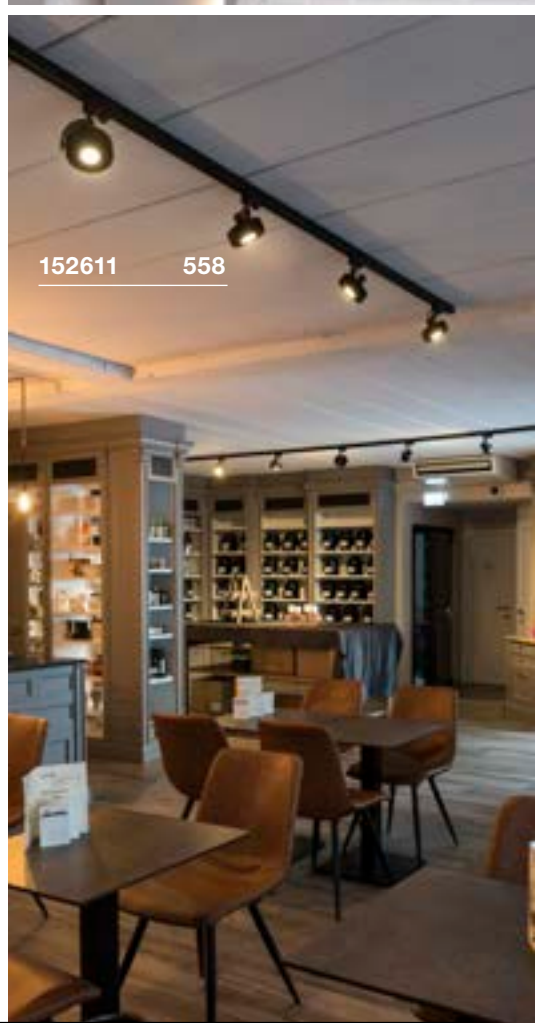



BIMA
3-phase, single, QPAR51

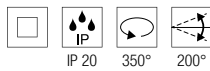
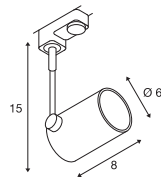

220-240V ~50/60Hz
Material: aluminium



Base: 1xGU10 Max. diameter: 5.1 cm L: 5.7 cm

Options	Prod. no.
● black	152240
○ white	152241
● grey	152242



LED GU10 51mm | 6W | 38°
2700K | 450lm | EEK=F
6kWh/1000h



Prod. no.: 1005077



BIMA
3-phase, double, QPAR51

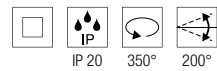
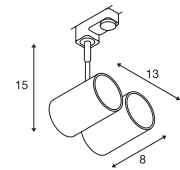

220-240V ~50/60Hz
Material: aluminium



Base: 2xGU10 Max. diameter: 5.1 cm L: 5.7 cm

Options	Prod. no.
● black	152230
○ white	152231
● grey	152232



LED GU10 51mm | 6W | 38°
2700K | 450lm | EEK=F
6kWh/1000h



Prod. no.: 1005075

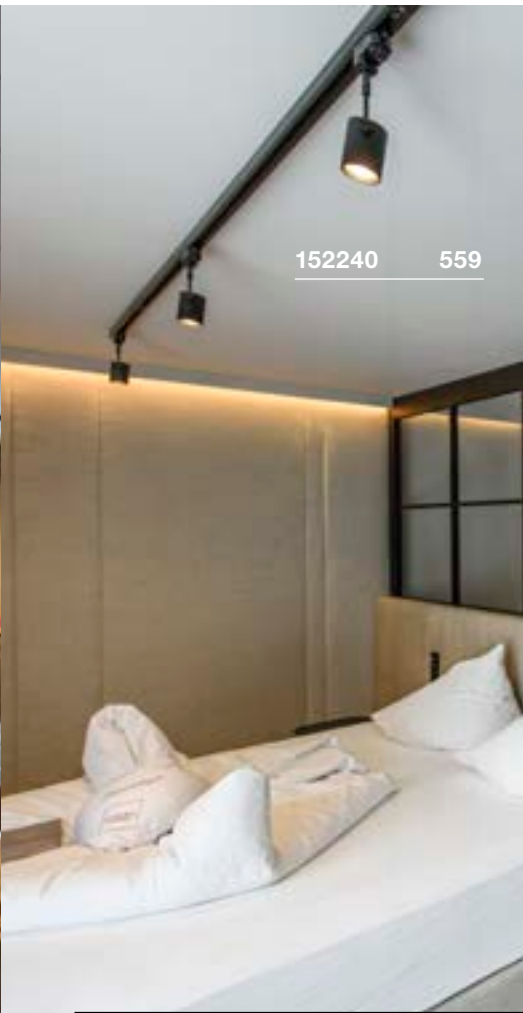



152960 561



152430 561



HELIA 50 TRACK 3-phase

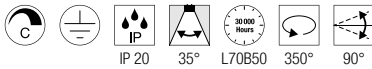
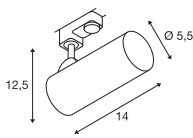

220-240V ~50/60Hz | 500mA
Total wattage: 11W
Material: aluminium



Down 810lm | 3000K
880lm

Options	Prod. no.
● black	
810lm	152960
○ white	
880lm	152961

ENOLA C TRACK 3-phase

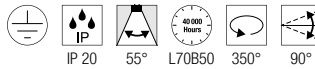
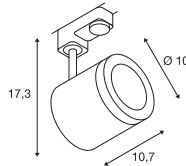

220-240V ~50/60Hz | 500mA
Total wattage: 11W
Material: aluminium



Down 1040lm | 3000K

Options	Prod. no.
● black	152430
○ white	152431

AVO TRACK 3-phase, QPAR51

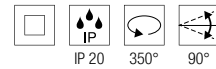
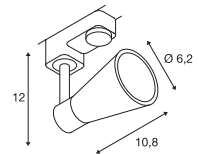

220-240V ~50/60Hz
Material: steel



Base: 1xGU10 Max. diameter: 5.1 cm

Options	Prod. no.
● black	152640
○ white	152641



LED GU10 51mm | 6W | 38°
2700K | 450lm | EEK=F
6kWh/1000h



Prod. no.: **1005077**

DESIGN YOUR HIGH-VOLTAGE TRACK SYSTEM

Professionally managed: well-designed lighting is essential, especially where there's plenty to see. Due to the versatility of track lighting, it's possible to showcase specific objects in the perfect light. Changes to the lighting design can also be made at any time. 3-phase high-voltage busbars are perfect for shops and exhibition stands. They create the perfect illumination and present products and exhibition items in just the right light. 1-phase high-voltage busbars are particularly suitable for private homes and bathe your living space in atmospheric light. Thanks to the boreholes present in their cross-section, these aluminium tracks can be attached to your ceiling quickly and easily. You can choose from a recessed version and a surface-mounted version, and both are available in multiple colours.

CHOOSE YOUR PREFERRED ...

- 1 Track (S-TRACK, EUTRAC, 1-phase system)
- 2 Assembly type (recessed/mounting track)
- 3 Lights
- 4 Design options



DONE!

TRACK SYSTEMS

S-TRACK
3-phase system



EUTRAC
3-phase system



1-PHASE SYSTEM



Recessed track



Mounting track



Ceiling



Wall



Pendant

Mounting options

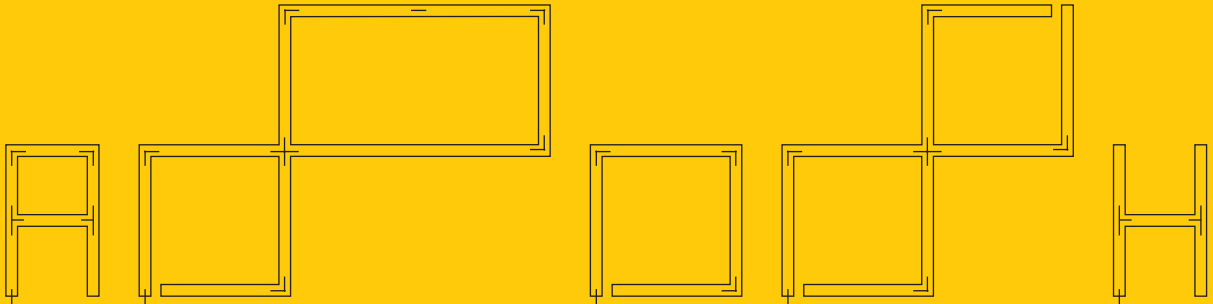

Various design options tailored to your room

Use our track configurator at slv.com



PROFILES

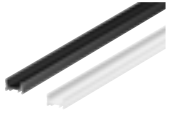

GRAZIA 10 SURFACE-MOUNTED PROFILE | 567



GRAZIA 10 RECESSED PROFILE | 567

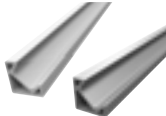

GRAZIA 10 EDGE | 570



GRAZIA 20 SURFACE-MOUNTED PROFILE | 573



GRAZIA 20 RECESSED PROFILE | 573

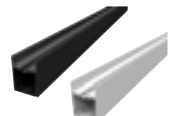

GRAZIA 60 SURFACE-MOUNTED PROFILE | 577

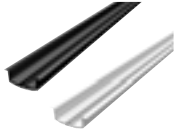

GRAZIA 60 RECESSED PROFILE | 577



GRAZIA 10 ACCESSORIES | 569



GRAZIA 10 EDGE ACCESSORIES | 571



GRAZIA 20 ACCESSORIES | 574-575



GRAZIA 60 ACCESSORIES | 578-579

LED STRIPS



GRAZIA FLEXSTRIP LED | 582



GRAZIA PRO FLEXSTRIP LED | 583



GRAZIA PRO MAX FLEXSTRIP | 585



GRAZIA PRO FLEXSTRIP TUNABLE WHITE | 587



GRAZIA PRO FLEXSTRIP RGBW | 589



GRAZIA IP FLEXSTRIP | 591



GRAZIA FLEXSTRIP LED ACCESSORIES | 582



GRAZIA PRO FLEXSTRIP LED ACCESSORIES | 583



GRAZIA PRO MAX FLEXSTRIP ACCESSORIES | 585



GRAZIA PRO FLEXSTRIP TUNABLE WHITE ACCESSORIES | 587



GRAZIA PRO FLEXSTRIP RGBW ACCESSORIES | 589



GRAZIA 10

Surface-mounted profile, flat 2m

Material: aluminium,
 Width: 1.75 cm, Height: 1.1 cm,
 Max. LED strip width in mm: 10
 Cover not included

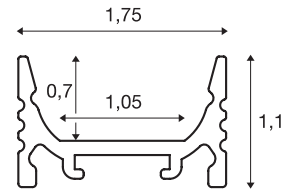

Length (cm)	Colour	Material	Prod. no.
200	● black	aluminium	1000462
	○ white		1000461

GRAZIA 10

Surface-mounted profile, standard

Material: aluminium
 Width: 1.75 cm, Height: 1.62 cm
 Max. LED strip width in mm: 10
 Cover not included

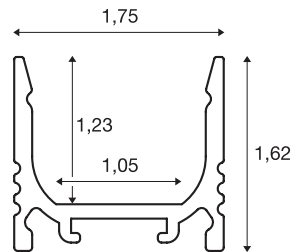
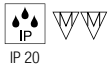

Length (cm)	Colour	Material	Prod. no.
200	● black	aluminium	1000465
	○ white		1000464

GRAZIA 10

Recessed profile

Material: aluminium
 Width: 3 cm, Height: 1.62 cm
 Max. LED strip width in mm: 10
 Cover not included

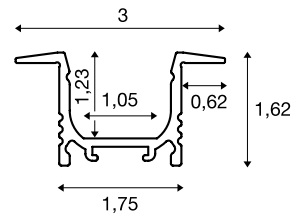
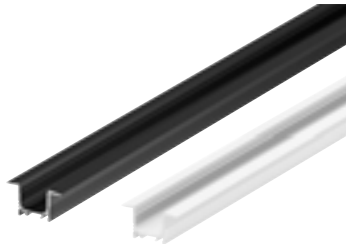
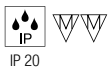

Length (cm)	Colour	Material	Prod. no.
200	● black	aluminium	1000459
	○ white		1000458



ACCESSORIES

GRAZIA 10 Cover



Description	Colour	Length (cm)	Width (cm)	Height (cm)	Material	Prod. no.
Cover	<input type="radio"/> frosted	200	1,58	0,4	Polycarbonate (PC)	1000466
	<input type="radio"/> opaque				Polymethylacrylate (PMMA)	1000468
	<input type="radio"/> satin finish					1000469

GRAZIA 10 Mounting clips



Description	Colour	Width (cm)	Height (cm)	Depth (cm)	Material	Prod. no.
Mounting clips	<input type="radio"/> silver, 45°	1,62	1,62	1	Steel	1000489
	<input type="radio"/> stainless steel, not visible	1,53	0,3	1	Stainless steel	1000487

Packaging contents: 2 units

GRAZIA 10 End caps for surface-mounted profile

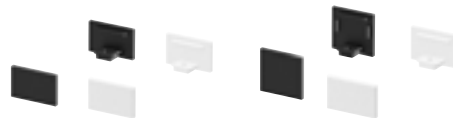

Description	Colour	Length (cm)	Width (cm)	Height (cm)	Material	Prod. no.
End caps	<input checked="" type="radio"/> black, flat	-	1,75	1,1	aluminium	1000477
	<input type="radio"/> white, flat			1,1		1000476
End caps	<input checked="" type="radio"/> black, standard	-	1,75	1,62	aluminium	1000480
	<input type="radio"/> white, standard			1,62		1000479

Packaging contents: 2 units

GRAZIA 10 End caps for recessed profile



Description	Colour	Length (cm)	Width (cm)	Height (cm)	Material	Prod. no.
End caps	<input checked="" type="radio"/> black	-	3	1,62	aluminium	1000474
	<input type="radio"/> white					1000473

Packaging contents: 2 units



GRAZIA 10 EDGE

2 m

Material: aluminium
 Width: 1.95 cm, Height: 1.95 cm
 Max. LED strip width in mm: 10
 Cover not included

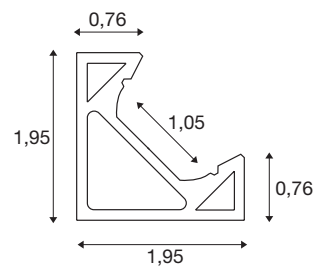
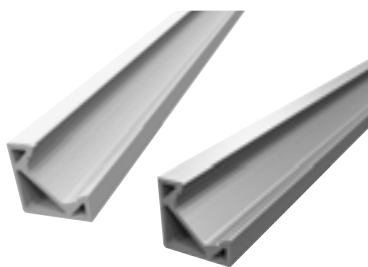

Length (cm)	Colour	Material	Prod. no.
200	<input type="radio"/> white	aluminium	1004890
	<input checked="" type="radio"/> aluminium		1004889

ACCESSORIES

GRAZIA 10 EDGE Cover



Description	Colour	Length (cm)	Width (cm)	Height (cm)	Material	Prod. no.
Cover	<input type="radio"/> frosted	200	1,58	0,4	Polycarbonate (PC)	1000466
	<input type="radio"/> opaque				Polymethylacrylate (PMMA)	1000468
	<input type="radio"/> satin finish					1000469

GRAZIA 10 EDGE End cap



Description	Colour	Length (cm)	Width (cm)	Height (cm)	Material	Prod. no.
End cap	<input type="radio"/> white	2	0,7	2	ABS	1004894
	<input checked="" type="radio"/> aluminium					1004893

Packaging contents: 2 units

GRAZIA 10 EDGE Mounting clips



Description	Colour	Length (cm)	Width (cm)	Height (cm)	Material	Prod. no.
Mounting clips	<input checked="" type="radio"/> Stainless steel	2,25	15	2,25	Steel	1004895

Packaging contents: 4 units



GRAZIA 20

Standard surface-mounted profile,
3 m

Material: aluminium
Width: 3.5 cm, Height: 3.2 cm
Max. LED strip width in mm: 20
Cover not included

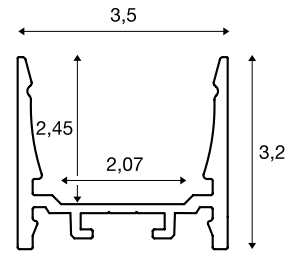
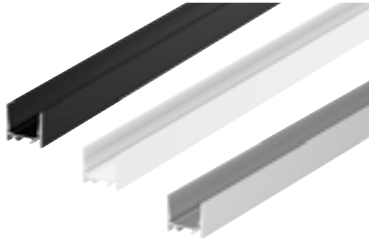

Length (cm)	Colour	Material	Prod. no.
300	● black	aluminium	1000525
	○ white		1000524
	● aluminium		1000523

GRAZIA 20

Surface-mounted profile, flat, 3m

Material: aluminium
Width: 3.5 cm, Height: 2.2 cm
Max. LED strip width in mm: 20
Cover not included

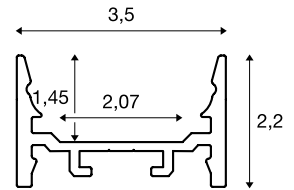

Length (cm)	Colour	Material	Prod. no.
300	● black	aluminium	1000534
	○ white		1000533

GRAZIA 20

Recessed profile, 3m

Material: aluminium
Width: 5.2 cm, Height: 3.2 cm
Max. LED strip width in mm: 20
Cover not included

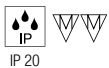
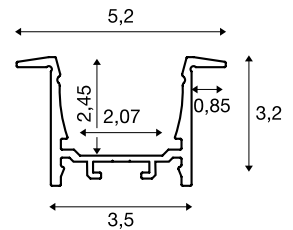

Length (cm)	Colour	Material	Prod. no.
300	● black	aluminium	1000498
	○ white		1000497

ACCESSORIES

GRAZIA 20 Cover, 3m, flat



Description	Colour	Length (cm)	Width (cm)	Height (cm)	Material	Prod. no.
Cover	<input type="radio"/> frosted	300	3,2	0,6	Polycarbonate (PC)	1000540
	<input type="radio"/> frosted				Polymethylacrylate (PMMA)	1000546
	<input type="radio"/> opaque					1000549

GRAZIA 20 Longitudinal connector



Description	Colour	Length (cm)	Width (cm)	Height (cm)	Material	Prod. no.
Longitudinal connector	<input type="radio"/> aluminium	3,8	1,4	0,4	aluminium	1000571

Packaging contents: 2 units

GRAZIA 20 End caps for surface-mounted profile

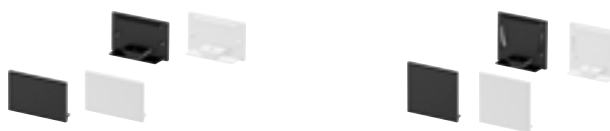

Description	Colour	Length (cm)	Width (cm)	Height (cm)	Material	Prod. no.
End cap	<input checked="" type="radio"/> black, flat	-	3,5	2,2	aluminium	1000561
	<input type="radio"/> white, flat					1000560
End cap	<input checked="" type="radio"/> black, standard	-	3,5	3,2	aluminium	1000567
	<input type="radio"/> white, standard					1000566

Packaging contents: 2 units

GRAZIA 20
End cap for recessed profile



Description	Colour	Length (cm)	Width (cm)	Height (cm)	Material	Prod. no.
End cap	<input checked="" type="radio"/> black	-	5,2	3,2	aluminium	1000558
	<input type="radio"/> white					1000557

Packaging contents: 2 units

GRAZIA 20
Pendant suspension



Description	Colour	Length (cm)	Material	Prod. no.
Pendant suspension	<input type="radio"/> silver	200	Steel	1000535

Packaging contents: 2 units

GRAZIA 20
Mounting clips



Description	Colour	Length (cm)	Width (cm)	Height (cm)	Material	Prod. no.
Mounting clip	<input type="radio"/> silver	2	3	0,8	Steel	1000536
Mounting clip	<input checked="" type="radio"/> chrome/aluminium	5,5	7	2,3	Steel/aluminium	1004932

Packaging contents: 2 units



GRAZIA 60 Surface-mounted profile

Material: aluminium
Width: 7 cm, Height: 9.5 cm
Max. LED strip width in mm: 20
Cover not included

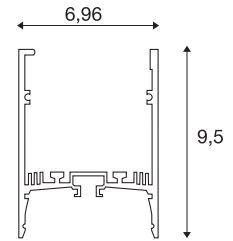
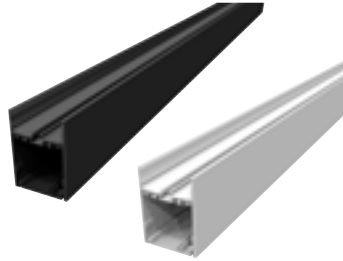

Length (cm)	Colour	Material	Prod. no.
150	● black	aluminium	1004896
150	○ white		1004897
300	● black	aluminium	1004898
300	○ white		1004899

GRAZIA 60 Recessed profile, 1.5m

Material: aluminium
Width: 8.6 cm, Height: 3.3 cm
Max. LED strip width in mm: 20
Cover not included

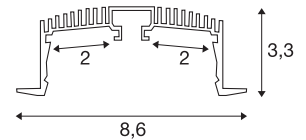
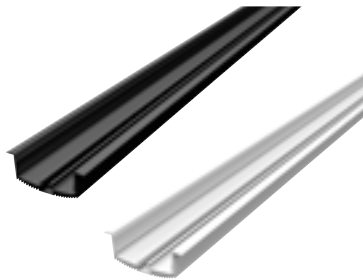

Length (cm)	Colour	Material	Prod. no.
150	● black	aluminium	1004905
150	○ white		1004906
300	● black	aluminium	1004907
300	○ white		1004908

ACCESSORIES

GRAZIA 60 Cover, 1.5m



Description	Colour	Length (cm)	Width (cm)	Height (cm)	Material	Prod. no.
Cover, 1.5m	● black	150	6,5	0,65	aluminium	1004912
	○ white				Polycarbonate (PC)	1004913
	○ frosted				Polymethylacrylate (PMMA)	1004914
	○ frosted				Polycarbonate (PC)	1004915
Cover, 3m	○ frosted	300	6,5		Polymethylacrylate (PMMA)	1004916
	○ frosted				Polymethylacrylate (PMMA)	1004917

GRAZIA 60 End caps

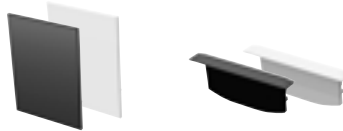

Description	Colour	Length (cm)	Width (cm)	Height (cm)	Material	Prod. no.
End caps for surface-mounted profile	● black	–	7	9,5	aluminium	1004900
	○ white	–				1004901
End caps for recessed profile	● black	–	8,6	3,3	aluminium	1004909
	○ white	–				1004910

Packaging contents: 2 units

GRAZIA 60 Surface-mounted profile, mounting profile



Description	Colour	Length (cm)	Width (cm)	Height (cm)	Material	Prod. no.
Mounting profile	● black	150	6,1	1,2	aluminium	1004902

GRAZIA 60

Surface-mounted profile,
longitudinal connector



Description	Colour	Length (cm)	Width (cm)	Height (cm)	Material	Prod. no.
Longitudinal connector	● aluminium	8	4,2	1	aluminium	1004903

Packaging contents: 2 units

GRAZIA 60

Surface-mounted profile, feed-in



Description	Colour	Length (cm)	Width (cm)	Height (cm)	Material	Prod. no.
Feed-in	● aluminium	8	4,2	2,4	aluminium	1004904

GRAZIA 60

Recessed profile, mounting clip



Description	Colour	Length (cm)	Width (cm)	Height (cm)	Material	Prod. no.
Mounting clip	● chrome	13	2,8	4	aluminium	1004911

Packaging contents: 2 units

CONTROLLER

LED Strip CCT / RGBW



Description	Colour	Length (cm)	Width (cm)	Height (cm)	Material	Prod. no.
Controller	○ white	14,5	4,65	1,6	Polycarbonate (PC)	1006348

DESIGN YOUR LED PROFILE

Create accents or illuminate entire rooms – available with up to 700 lm per 5 m.

Bring colour into play – LED strips available in white, as CCT (Tunable White) or RGBW version.

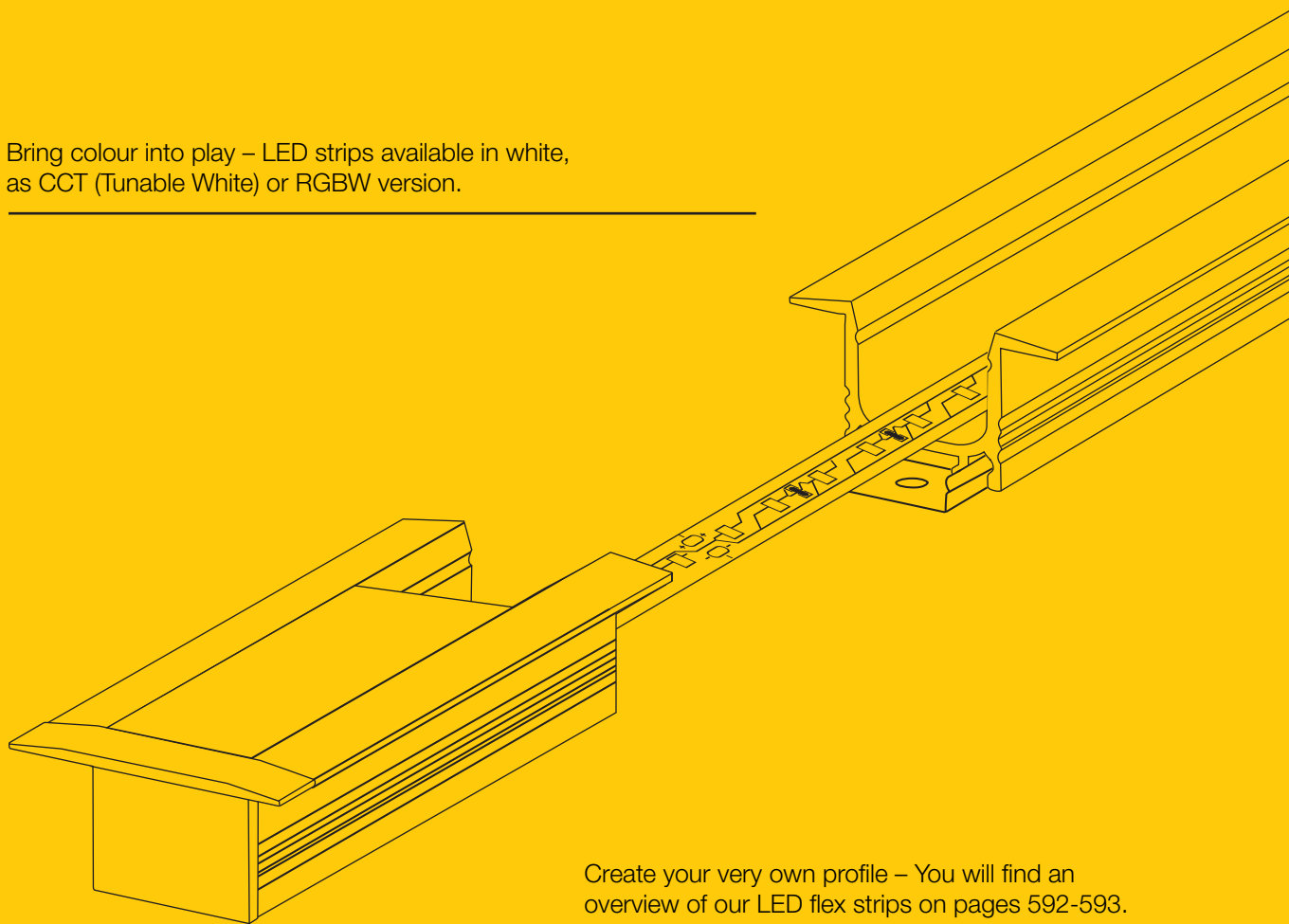

Create your very own profile – You will find an overview of our LED flex strips on pages 592-593. Matching drivers are presented on our Accessories pages 866-881.



We recommend a new
feed-in for double-sided
lengths over 3 m and
from 5 m

Frosted, opaque or transparent, in flat or tall
version – Choose from different covers for
a more personal touch.

For indoors, outdoors and wet rooms.
With IP20 and IP54, equipped for all applications.

Whether a standard or flat surface-mounted profile,
recessed profile or corner profile: we've got the
right profile for your project.

With lengths from 5 m to 80 m, there are no
limits – increase or shorten as desired.
Thanks to 24V technology, you can create
long lengths with fewer feed-in points.



GRAZIA FLEXSTRIP LED 24V

LEDs per metre: 70
 Width: 1 cm
 Height: 0.12 cm
 LED gap: 1.4 cm
 Can be separated every: 10 cm
 IP code: IP 20
 Feed-in cable on both sides



Colour temperature (K)	Luminous flux (lm)	Output (W)	Colour rendering index (CRI)	Colour consistency (SDCM)	Length (cm)	Prod. no.
2700	3500	44	90	3	500	1004708
3000	3500	44				1004709
4000	3750	44				1004710



Options	Material	Length (cm)	Width (cm)	Height (cm)	Prod. no.
<input type="radio"/> LED power supply 50W, triac dim	Polycarbonate (PC)	18.4	6.1	3.2	1003104
<input type="radio"/> LED power supply 25W, triac dim		12.8	5.2	3	1006336
<input type="radio"/> LED power supply 30W, Slim Line, on/off		30	3	1.6	1007250
<input type="radio"/> LED power supply 30W, Slim Line, DALI					1007254
<input type="radio"/> LED power supply 100W, Slim Line, on/off		35	1.8	1007251	
<input type="radio"/> LED power supply 100W, Slim Line, DALI				1007255	



GRAZIA PRO FLEXSTRIP 24V

LEDs per metre: 126
 Width: 1 cm
 Height: 0.12 cm
 LED gap: 0.8 cm
 Can be separated every 5.6 cm
 IP code: IP 20
 Feed-in cable on both sides



Colour temperature (K)	Luminous flux (lm)	Output (W)	Colour rendering index (CRI)	Colour consistency (SDCM)	Length (cm)	Prod. no.
2700	6500	73	90	3	500	1004712
3000	6500	73				1004713
4000	7000	73				1004714



Options	Material	Length (cm)	Width (cm)	Height (cm)	Prod. no.
<input type="radio"/> LED power supply 50W, triac dim	Polycarbonate (PC)	18.4	6.1	3.2	1003104
<input type="radio"/> LED power supply 25W, triac dim		12.8	5.2	3	1006336
<input type="radio"/> LED power supply 30W, Slim Line, on/off		30	3	1.6	1007250
<input type="radio"/> LED power supply 30W, Slim Line, DALI				1007254	
<input type="radio"/> LED power supply 100W, Slim Line, on/off		35	3	1.8	1007251
<input type="radio"/> LED power supply 100W, Slim Line, DALI				1007255	

To ensure heat dissipation, the LED strips must be glued into an aluminium profile. Reverse of the LED strip with adhesive tape.
 In order to obtain a consistent light output from a length of 3 m, we recommend feeding the strips on both sides.
 From a length of 5 m, a new feed-in must be provided.



GRAZIA PRO FLEXSTRIP 24V

LEDs per metre: 168
 Width: 1 cm
 Height: 0.12 cm
 LED gap: 0.6 cm
 Can be separated every 4.2 cm
 IP code: IP 20
 Feed-in cable on both sides



Colour temperature (K)	Luminous flux (lm)	Output (W)	Colour rendering index (CRI)	Colour consistency (SDCM)	Length (cm)	Prod. no.
2700	8500	91	90	3	500	1004716
3000	8500	91				1004717
4000	9100	91				1004718
6500	9100	91				1004719



Options	Material	Length (cm)	Width (cm)	Height (cm)	Prod. no.
<input type="radio"/> LED power supply 50W, triac dim	Polycarbonate (PC)	18.4	6.1	3.2	1003104
<input type="radio"/> LED power supply 25W, triac dim		12.8	5.2	3	1006336
<input type="radio"/> LED power supply 30W, Slim Line, on/off		30	3	1.6	1007250
<input type="radio"/> LED power supply 30W, Slim Line, DALI					1007254
<input type="radio"/> LED power supply 100W, Slim Line, on/off		35	3	1.8	1007251
<input type="radio"/> LED power supply 100W, Slim Line, DALI					1007255



GRAZIA PRO MAX FLEXSTRIP 24V

LEDs per metre: 196
 Width: 2 cm
 Height: 0.15 cm
 LED gap: 0.5 cm
 Can be separated every 3.6 cm
 IP code: IP 20
 Feed-in cable on both sides



Colour temperature (K)	Luminous flux (lm)	Output (W)	Colour rendering index (CRI)	Colour consistency (SDCM)	Length (cm)	Prod. no.
3000	12500	126	90	3	500	1004720
4000	13000	126				1004721



Options	Material	Length (cm)	Width (cm)	Height (cm)	Prod. no.
<input type="radio"/> LED power supply 150W, Slim Line, on/off	Polycarbonate (PC)	35	3	1.8	1007252
<input type="radio"/> LED power supply 150W, Slim Line, DALI					1007256

To ensure heat dissipation, the LED strips must be glued into an aluminium profile. Reverse of the LED strip with adhesive tape.
 In order to obtain a consistent light output from a length of 3 m, we recommend feeding the strips on both sides.
 From a length of 5 m, a new feed-in must be provided.



GRAZIA PRO MAX FLEXSTRIP 24V

LEDs per metre: 196
 Width: 2 cm
 Height: 0.15 cm
 LED gap: 1 cm
 Can be separated every 7.1 cm
 IP code: IP 20
 Feed-in cable on both sides



Colour temperature (K)	Luminous flux (lm)	Output (W)	Colour rendering index (CRI)	Colour consistency (SDCM)	Length (cm)	Prod. no.
3000	20000	193	90	3	500	1004722
4000	21400					1004723



Options	Material	Length (cm)	Width (cm)	Height (cm)	Prod. no.
<input type="radio"/> LED power supply 250W, Slim Line, on/off	Polycarbonate (PC)	40	4	2.2	1007253
<input type="radio"/> LED power supply 250W, Slim Line, DALI					1007257



GRAZIA PRO FLEXSTRIP

tunable white, 24V

LEDs per metre: 224
 Width: 1 cm
 Height: 0.12 cm
 LED gap: 0.9 cm
 Can be separated every 6.3 cm
 IP code: IP 20
 Feed-in cable on both sides



Colour temperature (K)	Luminous flux (lm)	Output (W)	Colour rendering index (CRI)	Colour consistency (SDCM)	Length (cm)	Prod. no.
2700-6500	3400-3700	40	90	6	500	1004725



Options	Material	Length (cm)	Width (cm)	Height (cm)	Prod. no.
<input type="radio"/> DALI Controller 1 channel, push-dim	Polycarbonate (PC)	11.6	4.2	1.8	1003106
<input type="radio"/> LED power supply 60W, DALI, 2 channel		20.2	5.8	3	1006133
<input type="radio"/> SMART Controller 1-5 channel, selectable via DIP		14.5	4.65	1.6	1006348
<input type="radio"/> LED power supply 100W, Slim Line, on/off		35	3	1.8	1007251
<input type="radio"/> LED power supply 100W, Slim Line, DALI					1007255

To ensure heat dissipation, the LED strips must be glued into an aluminium profile. Reverse of the LED strip with adhesive tape.
 In order to obtain a consistent light output from a length of 3 m, we recommend feeding the strips on both sides.
 From a length of 5 m, a new feed-in must be provided.



GRAZIA PRO FLEXSTRIP RGBW, 24V

LEDs per metre: 70
 Width: 1.2 cm
 Height: 0.22 cm
 LED gap: 1.4 cm
 Can be separated every: 10 cm
 IP code: IP 20
 Feed-in cable on both sides



Colour temperature (K)	Luminous flux (lm)	Output (W)	Colour rendering index (CRI)	Colour consistency (SDCM)	Length (cm)	Prod. no.
RGB W 3000	2500 2050	60 27	90	6	500	1004727



Options	Material	Length (cm)	Width (cm)	Height (cm)	Prod. no.
<input type="radio"/> SMART Controller 1-5 channel, selectable via DIP	Polycarbonate (PC)	14.5	4.65	1.6	1006348
<input type="radio"/> LED power supply 100W, Slim Line, on/off		35	3	1.8	1007251

To ensure heat dissipation, the LED strips must be glued into an aluminium profile. Reverse of the LED strip with adhesive tape.
 In order to obtain a consistent light output from a length of 3 m, we recommend feeding the strips on both sides.
 From a length of 5 m, a new feed-in must be provided.

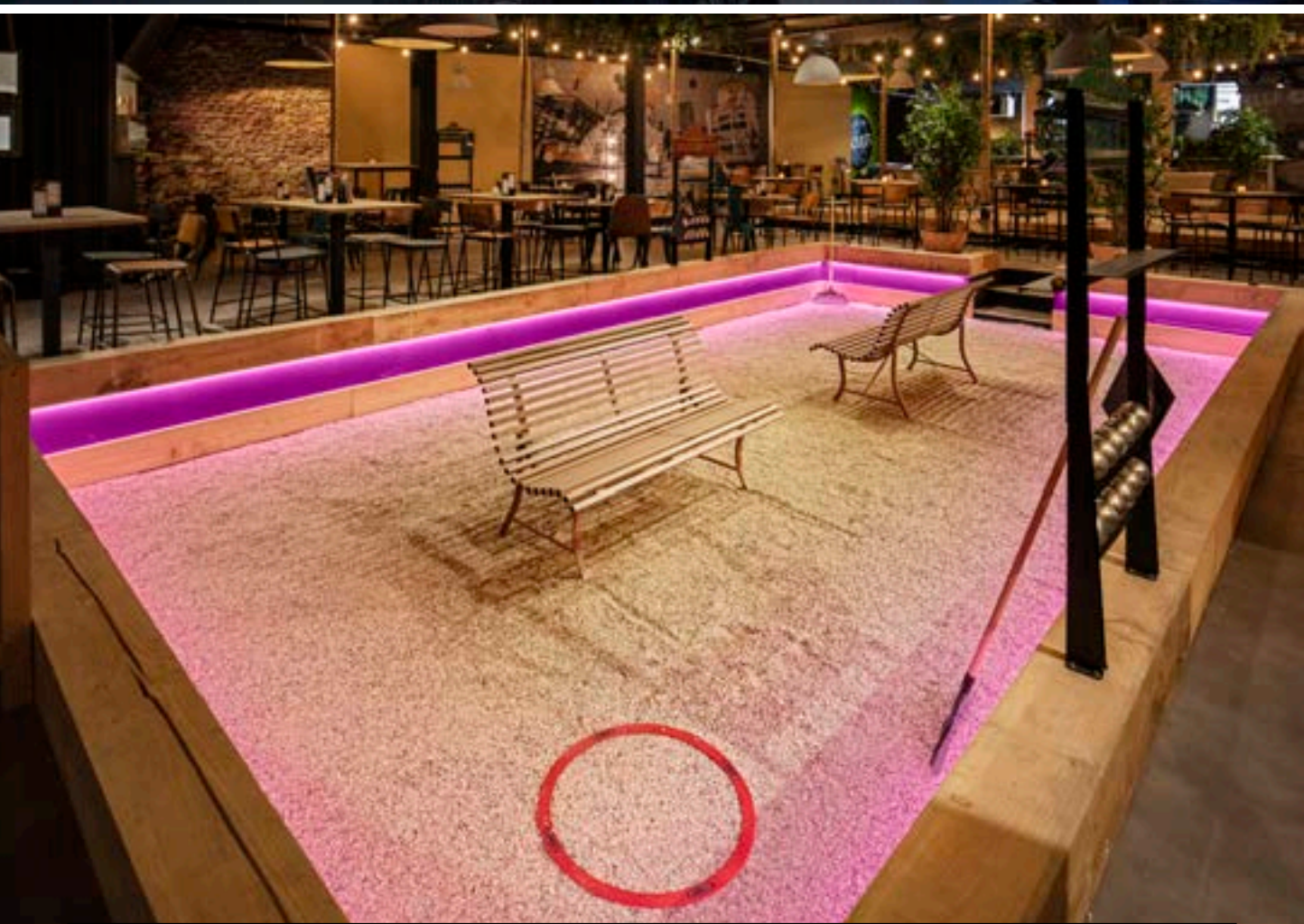

GRAZIA IP FLEXSTRIP 24V

LEDs per metre: 70
 Width: 1.2 cm
 Height: 0.4 cm
 LED gap: 1.4 cm
 Can be separated every: 10 cm
 IP code: IP 54
 Feed-in cable on both sides



Colour temperature (K)	Luminous flux (lm)	Output (W)	Colour rendering index (CRI)	Colour consistency (SDCM)	Length (cm)	Prod. no.
2700	3350					1004734
3000	3350	44	90	4	502	1004735
4000	3600					1004736

GRAZIA IP FLEXSTRIP tunable white, 24V

LEDs per metre: 224
 Width: 1.2 cm
 Height: 0.4 cm
 LED gap: 0.9 cm
 Can be separated every 6.3 cm
 IP code: IP 54
 Feed-in cable on both sides



Colour temperature (K)	Luminous flux (lm)	Output (W)	Colour rendering index (CRI)	Colour consistency (SDCM)	Length (cm)	Prod. no.
2700-6500	3210-3500	40	90	4	502	1004726

Incl. 2 end caps and fittings

GRAZIA IP FLEXSTRIP RGBW, 24V

LEDs per metre: 70
 Width: 1.4 cm
 Height: 0.46 cm
 LED gap: 1.4 cm
 Can be separated every: 10 cm
 IP code: IP 54
 Feed-in cable on both sides



Colour temperature (K)	Luminous flux (lm)	Output (W)	Colour rendering index (CRI)	Colour consistency (SDCM)	Length (cm)	Prod. no.
RGB	2350	60	90	6	502	1004737
W 3000	1958	27				

To ensure heat dissipation, the LED strips must be glued into an aluminium profile. Reverse of the LED strip with adhesive tape.
 In order to obtain a consistent light output from a length of 3 m, we recommend feeding the strips on both sides.
 From a length of 5 m, a new feed-in must be provided.

FLEXSTRIPS

OVERVIEW

GRAZIA LED

1004708
1004709
1004710

70 LEDs/m

GRAZIA PRO

1004712
1004713
1004714

126 LEDs/m

GRAZIA PRO

1004716
1004717
1004718
1004719

168 LEDs/m

GRAZIA PRO MAX

1004720
1004721

196 LEDs/m

GRAZIA PRO MAX

1004722
1004723

196 LEDs/m

500
cm





All GRAZIA LED strips are based on 24V.
Matching drivers and additional accessories can be found on page 582.



**GRAZIA
PRO MAX**
TUNABLE WHITE
1004725

224 LEDs/m

**GRAZIA
PRO MAX**
RGBW
1004727

70 LEDs/m

**GRAZIA
IP**
1004734
1004735
1004736

70 LEDs/m

**GRAZIA
IP**
TUNABLE WHITE
1004726

224 LEDs/m

**GRAZIA
IP**
RGBW
1004737

70 LEDs/m

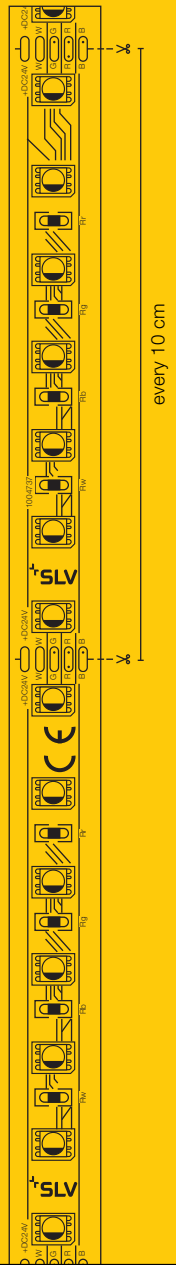
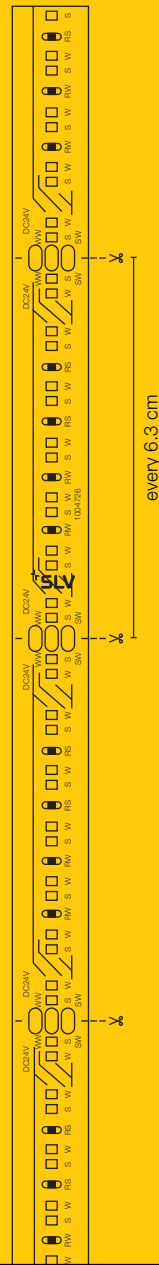
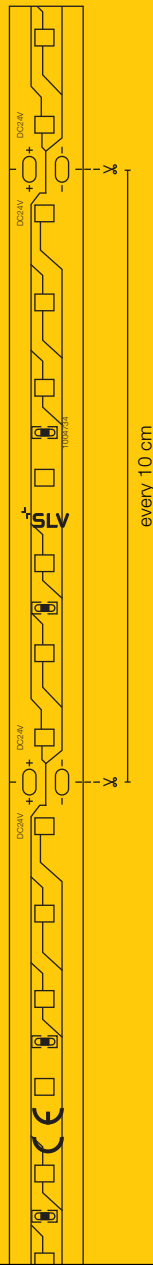
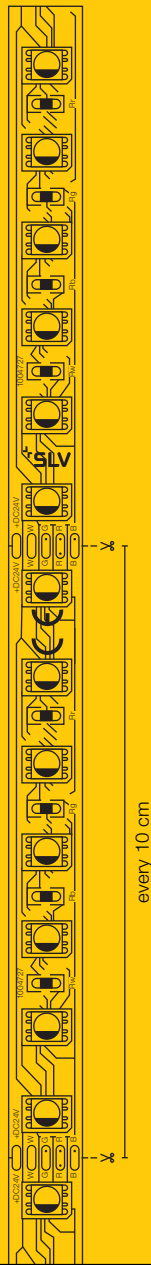
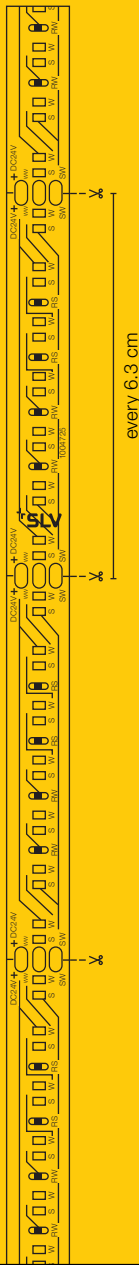



LED
VINOLINA ONE | 597



LED
VINOLINA | 597



LED
VINOLINA TWO | 599



LED
TONILA | 601



LED
TAHA | 601



SCKET
S-TUBE 32/75 | 603



SCKET
PHOTONI 45/75 | 605



LED
S-CUBE 35/75 | 607



LED
R-CUBE 35/70 | 609



LED
LID I 75 | 611

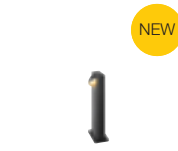

LED
LID I 45 | 611



LED
I-RING | 613



LED
M-POL S | 614



LED
M-POL S | 615



LED
M-POL S | 616



LED
M-POL S | 617



LED
M-POL S | 618



LED
M-POL M | 619



LED
M-POL M | 620



LED
M-POL M | 621



M-POL 30/60/90 | 623



SCKET
CONCRETO | 627



SCKET
CONCRETO | 627



LED
ESKINA
FRAME 45/75 | 629



LED
ESKINA
FRAME 75 | 629



LED
ESKINA
FRAME
125/175 | 630



LED
ESKINA 30/80 | 631



LED
LOGS 40/70 | 633



SCKET
GRAFIT 30/60/90 | 635



SCKET
GRAFIT 30/60/90 | 637



LED
QUADRULO | 639



LED
RUSTY®
SLOT 50/80 | 640



SCKET
RUSTY®
SLOT 50/80 | 641



SCKET
RUSTY®
PATHLIGHT | 642



LED
RUSTY® 40/70 | 643



SCKET
RUSTY® 40/70 | 643



SCKET
RUSTY®
CONE 24 | 645



SCKET
RUSTY®
CONE 40/70 | 645



SCKET
RUSTY® 40/70 | 646



SCKET
ARROCK
GRANITE 40/70 | 647



SCKET
ARROCK
ARC | 648



LED
ARROCK
STONE 50/75 | 649



SCKET
ARROCK SLOT | 649



LED
L-LINE OUT 30 | 650



LED
L-LINE OUT 60 | 651



LED
L-LINE
OUT 50/80 | 651



SCKET
THEO
PATHLIGHT | 652



LED
OVALISK 75/100 | 653



SCKET
GLOO PURE
27/44/70 | 655



SCKET
ROTOBALL
25/40/50 | 657



SCKET
PHOTONIA | 659



SCKET
PHOTONIA | 659



SCKET
OTOS GLAS | 659



SCKET
CUBIX | 660



SCKET
CONE | 660



SCKET
MOLAT | 661



SCKET
MOLAT | 661



SCKET
LISENNE 40/70 | 662



SCKET
ADEGAN
MANILA | 663



SCKET
ADEGAN | 663



SCKET
ALPA MUSHROOM
45/75 | 665



SCKET
ALPA CONE 100 | 665



LED
APONI 90/120 | 666



LED
TRUST 30/60 | 667



SCKET
BIG NAILS 50/80 | 668



SCKET
ROX ACRYL
30/60/90 | 669

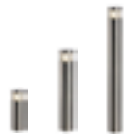

SCKET
VAP SLIM
30/60/90 | 671



SCKET
C-POL | 672



SCKET
F-POL | 672



SCKET
SQUARE
POLE 30/60/90 | 673



LED
SLOTS 45/65 | 675



LED
H-POL 30/60 | 676



LED
H-POL TWIN
30/60 | 677



LED
SLOTBOX 40/70 | 678



LED
FLATT 65/100 | 679



LED
ABRIDOR 60/100 | 681



LED
IPERI 50 | 681



SCKET
QUADRASYL 75 | 682



LED
QUAD POLE | 683



LED
BOOKAT | 683



LED
RASCALI 45/65 | 684



SCKET
MYRA SPOT | 685



SCKET
SITRA 360 | 685



1007357 597

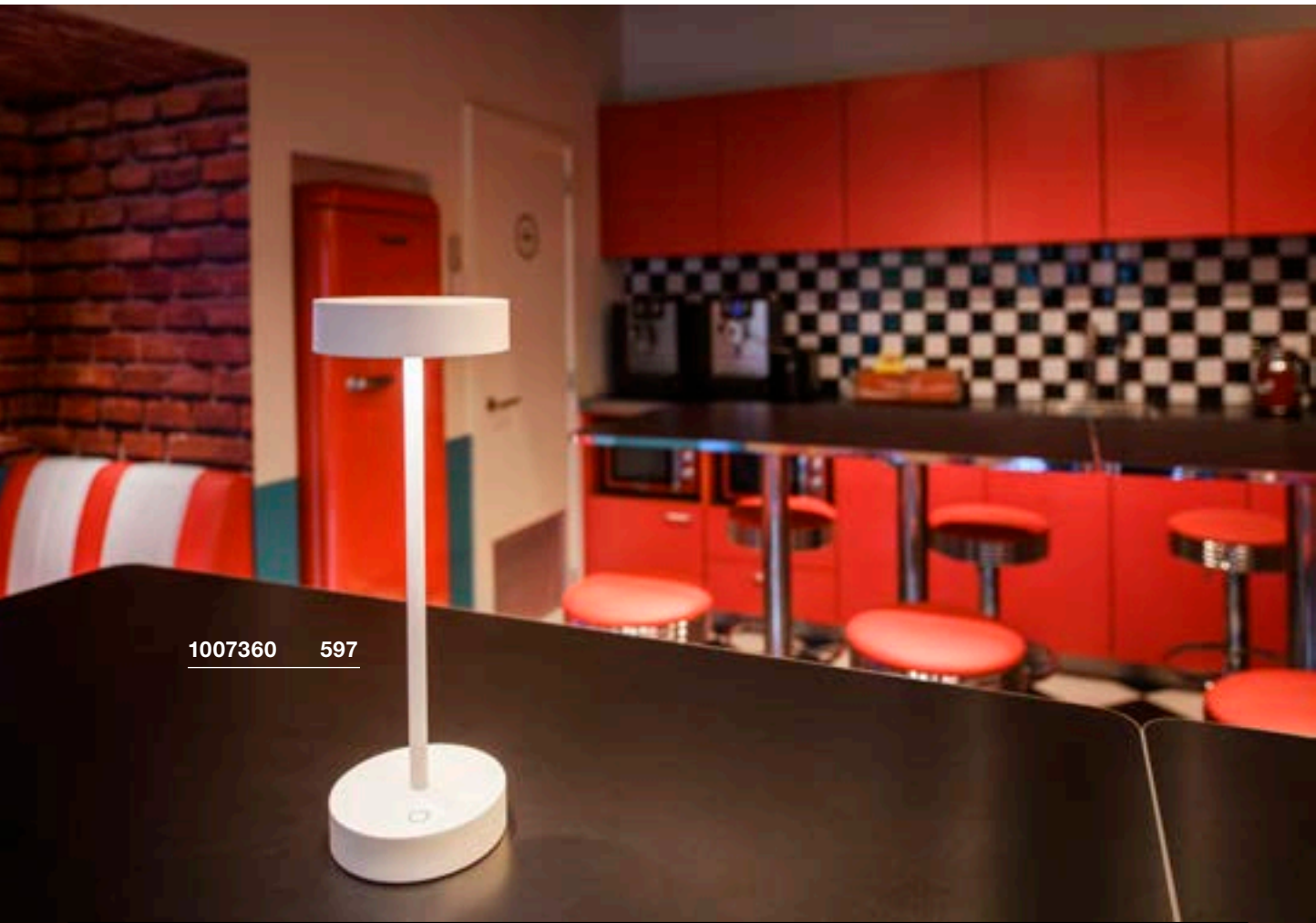

1007360 597



VINOLINA ONE TL, Battery

VINOLINA TL, Battery

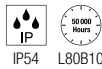
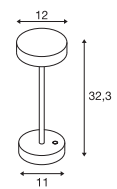
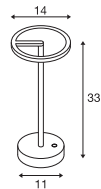
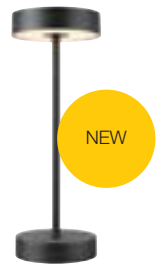

5V battery operation
Total wattage: 2.5W
Material: aluminium

- Running time 12h
- Charging time 7h
- Charging plate included
- Power adapter not included
- USB A

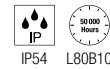

5V battery operation
Total wattage: 2.2W
Material: aluminium

- Running time 12h
- Charging time 7h
- Charging plate included
- Power adapter not included
- USB A



Down 125lm | 2700K



Down 130lm | 2700K | 130lm | 3000K

Options	Prod. no.
● black	1007359 ●
○ white	1007357 ●
● rust	1007358 ●

Options	Prod. no.
● black	1007362 ●
○ white	1007360 ●
● rust	1007361 ●



1007697 599



VINOLINA TWO TL, Battery

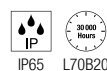
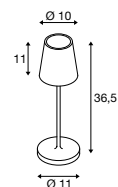

5V battery operation
Total wattage: 2W
Material: aluminium

- Touch dimmable
- Running time 10h
- Charging time 5h
- Charging station for one luminaire included



Down 190lm | 2200K
2700K
3000K

Options	Prod. no.
● black	1007693 ●
○ white	1007692 ●
● sand	1007697 ●
● rust	1007695 ●
● red	1007694 ●
● lime green	1007696 ●



1007380 601



1007380 601



TONILA TL

TAHA Light set, battery-powered

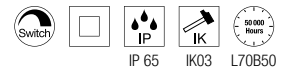
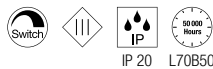
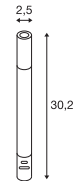
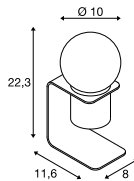

5V battery operation
Total wattage: 1.6W
Material: aluminium/plastic

- Battery 3.6V 2000mAh included
- Power adapter excluding USB charger 5V DC/1-2A required. For MINI-USB charging cable
- Can be dimmed to 3 different levels using the switch

100-240V ~50/60Hz | 5V battery operation
Total wattage: 5W
Max. U-out driver: 5V DC
Material: aluminium/plastic

- Charging cable included



Down 90lm | 2700K



Down 200lm | 2700K

Options	Prod. no.
● black	1002583

Options	Prod. no.
● black ●	1007380 ●

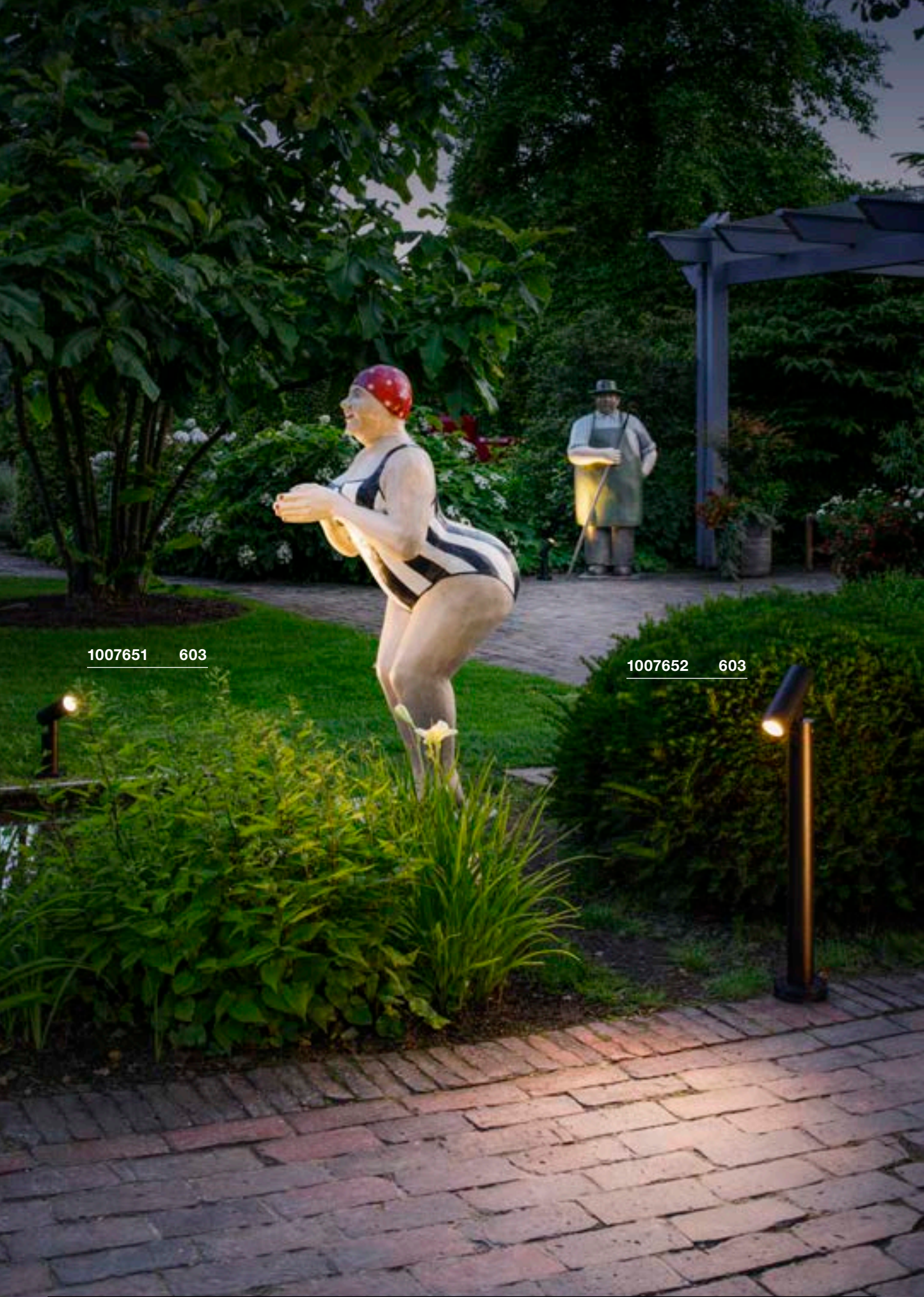

1007651 603

1007652 603



S-TUBE 32 Pole, GU10

S-TUBE 75 Pole, GU10

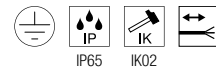
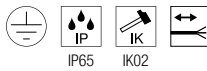
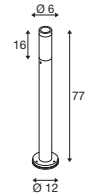
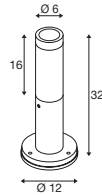

220-240V ~50/60Hz
Material: aluminium

220-240V ~50/60Hz
Material: aluminium

- Open cable end

- Open cable end



Base: 1xGU10 Max. diameter: 5 cm L: 5.5 cm

Base: 1xGU10 Max. diameter: 5 cm L: 5.5 cm

Options	Prod. no.
● black	1007651 ●

Options	Prod. no.
● black	1007652 ●



 LED GU10 51mm | 6W | 38°
 2700K | 450lm | EEK=F
 6kWh/1000h
 

Prod. no.: 1005077

 LED GU10 51mm | 6W | 38°
 2700K | 450lm | EEK=F
 6kWh/1000h
 

Prod. no.: 1005077

Product	Prod. no.
 Connection box IP68, 3-pole ● black	228730

Product	Prod. no.
 Connection box IP68, 3-pole ● black	228730



1007587 605

1007584 605



PHOTONI 45 Pole, E27

PHOTONI 75 Pole, E27

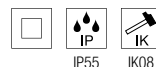
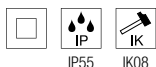
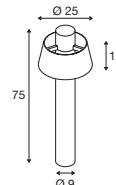
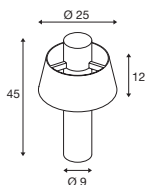
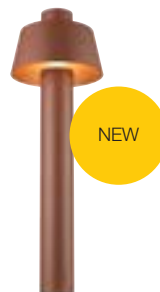

220-240V ~50/60Hz
Material: aluminium

220-240V ~50/60Hz
Material: aluminium

- IP connection box
- sea-air-resistant

- IP connection box
- sea-air-resistant



Base: 1xE27 Max. diameter: 6 cm L: 11.6 cm

Base: 1xE27 Max. diameter: 6 cm L: 11.6 cm

Options	Prod. no.
● black	1007587
● rust	1007583

Options	Prod. no.
● black	1007584
● rust	1007580



A60 | 7.5W | 180°
2700K | 720lm | EEK=F
8kWh/1000h



Prod. no.: 1005305



A60 | 7.5W | 180°
2700K | 720lm | EEK=F
8kWh/1000h



Prod. no.: 1005305



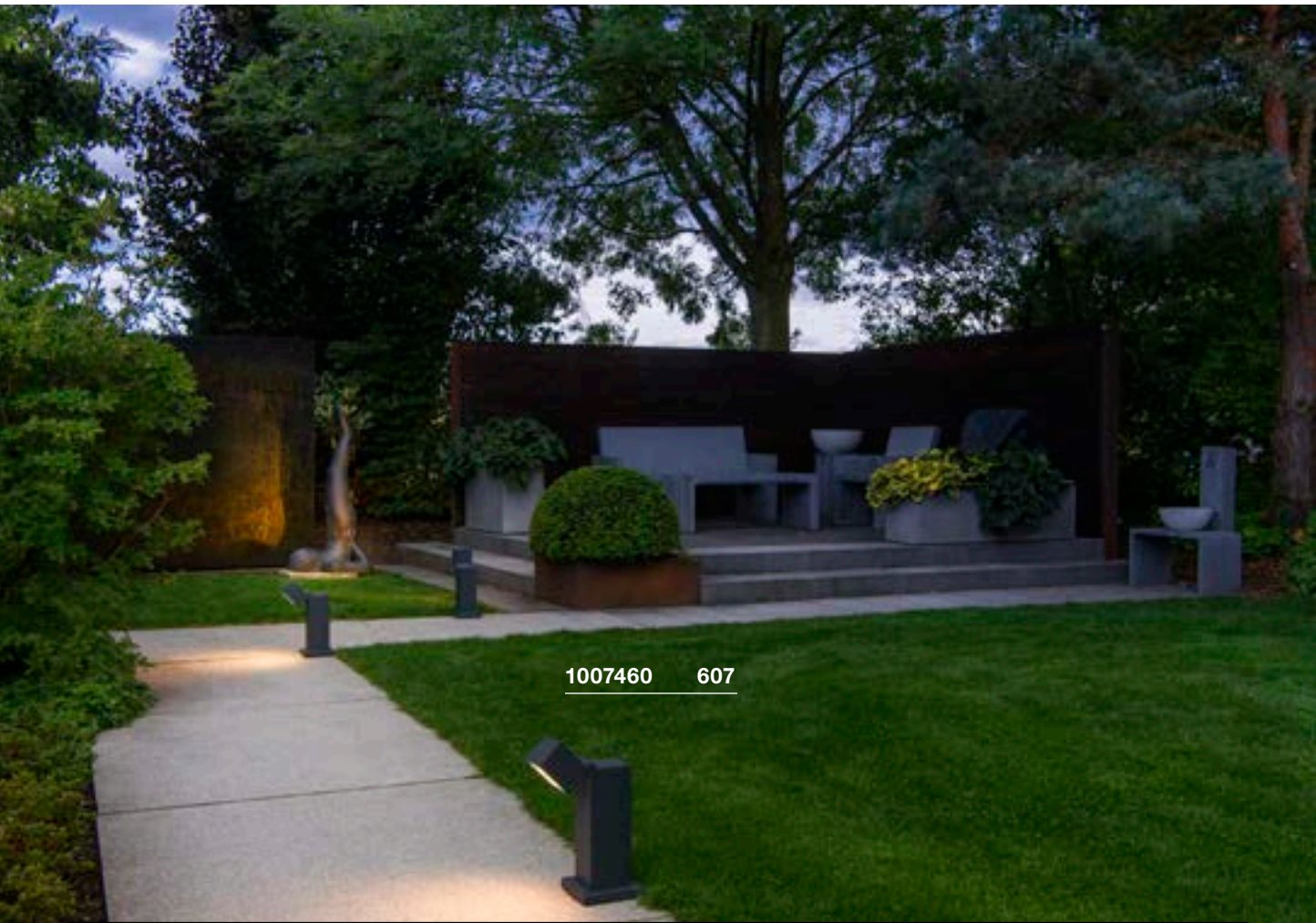



S-CUBE 35 Pole

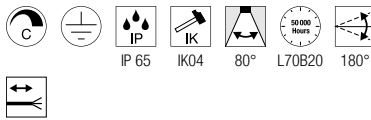
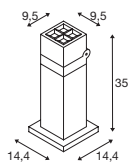

220-240V ~50/60Hz | 350mA
 Total wattage: 15W
 Material: aluminium

- Open cable end



Down 1000lm | 2700K | 1200lm | 3000K

Options	Prod. no.
● anthracite	1007460 ●



Product	Prod. no.
Connection box IP68, 3-pole	
● black	228730

S-CUBE 75 Pole

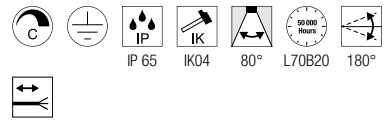
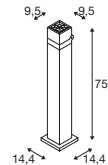

220-240V ~50/60Hz | 350mA
 Total wattage: 15W
 Material: aluminium

- Open cable end



Down 1000lm | 2700K | 1200lm | 3000K

Options	Prod. no.
● anthracite	1007459 ●



Product	Prod. no.
Connection box IP68, 3-pole	
● black	228730



1007513 609



R-CUBE 35 Pole

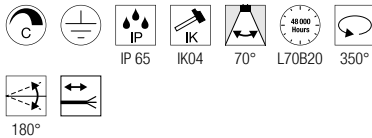
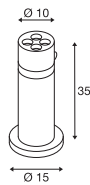
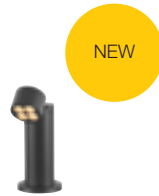

220-240V ~50/60Hz | 350mA
 Total wattage: 15W
 Material: aluminium

- Open cable end



Down 800lm | 2700K | 800lm | 3000K

Options	Prod. no.
● anthracite	1007513 ●



Product	Prod. no.
Connection box IP68, 3-pole	
● black	228730

R-CUBE 75 Pole

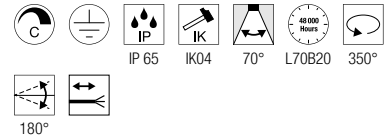
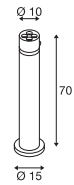

220-240V ~50/60Hz | 350mA
 Total wattage: 15W
 Material: aluminium

- Open cable end



Down 800lm | 2700K | 800lm | 3000K

Options	Prod. no.
● anthracite	1007512 ●



Product	Prod. no.
Connection box IP68, 3-pole	
● black	228730



1007670 611

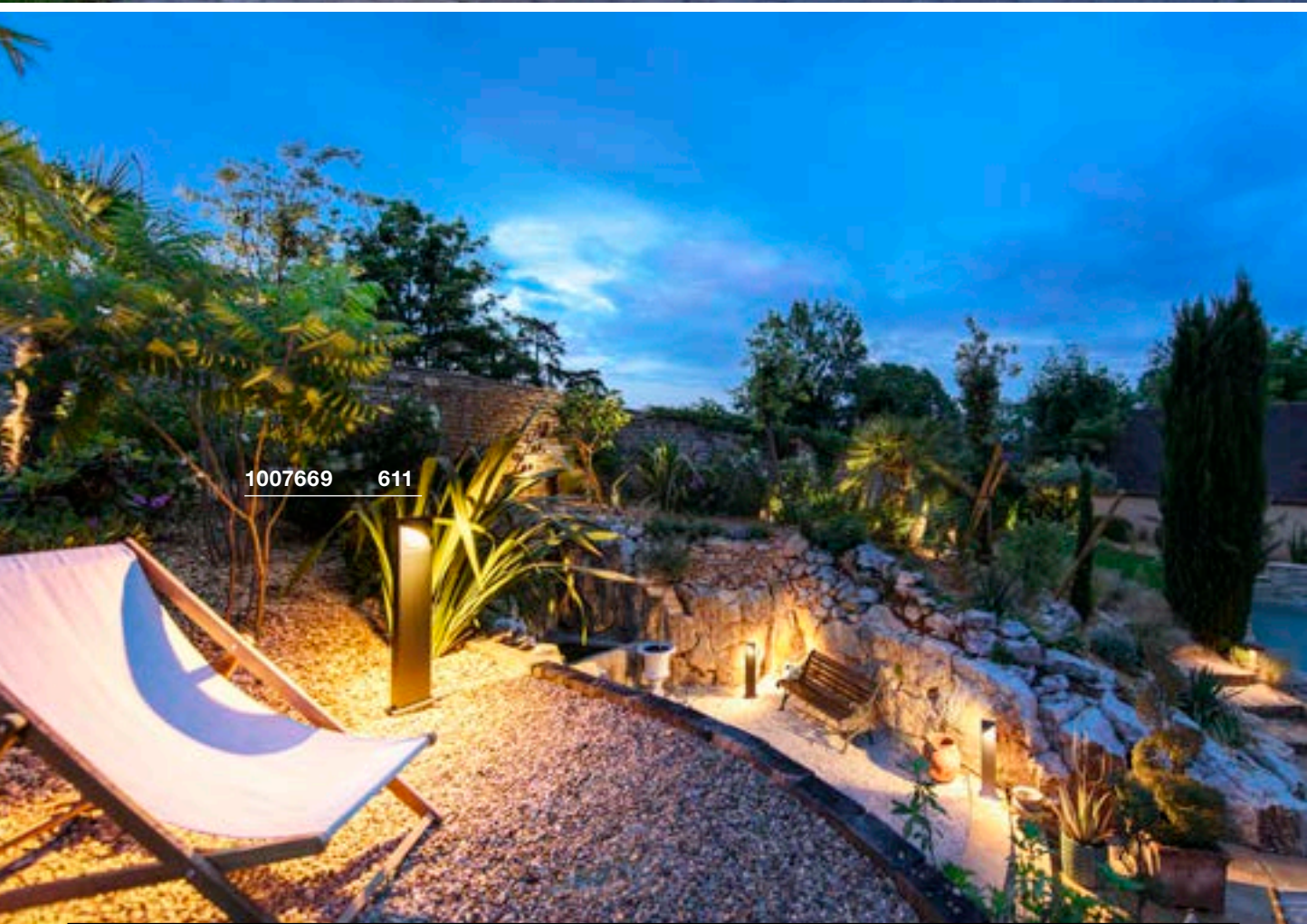

1007669 611



LID I 75 Pole, double

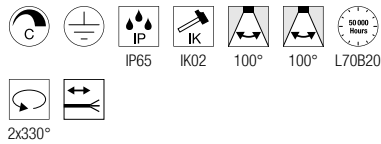
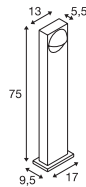

220-240V ~50/60Hz | 700mA
Total wattage: 29W
Material: aluminium

- Open cable end



Down 850lm | 2700K | 1000lm | 3000K

Options	Prod. no.
● anthracite	1007669 ●



Product	Prod. no.
Connection box IP68, 3-pole	
● black	228730

LID I 45 Pole, single

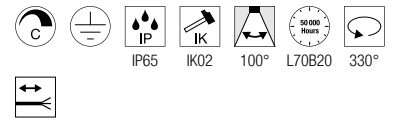
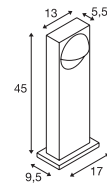

220-240V ~50/60Hz | 350mA
Total wattage: 15W
Material: aluminium

- Open cable end



Down 900lm | 2700K | 1050lm | 3000K

Options	Prod. no.
● anthracite	1007670 ●



Product	Prod. no.
Connection box IP68, 3-pole	
● black	228730



1007237 613



I-RING Pole

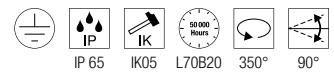
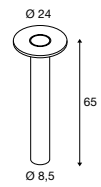

100-240V ~50/60Hz | 350mA
 Total wattage: 9.2W
 Material: aluminium



Down

670lm | 3000K

Options	Prod. no.
● anthracite	1007237 ●



Product	Prod. no.
Screw set	
● Stainless steel	228753

M-POL S
Polehead 360°, Glare reduction

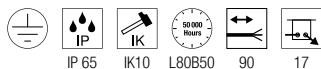
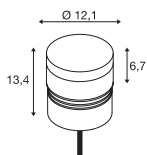

220-240V ~50/60Hz | 500mA
Total wattage: 10W
Material: aluminium



Down 750lm | 2700K

Options	Prod. no.
● anthracite	1007232 ●



Product	Prod. no.
pole	
● anthracite	
H: 23.4 cm	1006379
● anthracite	
H: 53.4 cm	1006380
● anthracite	
H: 83.4 cm	1006381
Ground anchor	
● Stainless steel	1006382
T-connector box	
● black	228726
Connection box IP68, 3-pole	
● black	228730

M-POL S
Polehead 360°, Glare reduction,
DALI

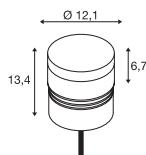

220-240V ~50/60Hz | 500mA
Total wattage: 10W
Material: aluminium



Down 750lm | 2700K

Options	Prod. no.
● anthracite	1007233 ●



Product	Prod. no.
pole	
● anthracite	
H: 23.4 cm	1006379
● anthracite	
H: 53.4 cm	1006380
● anthracite	
H: 83.4 cm	1006381
Ground anchor	
● Stainless steel	1006382
Connection box	
● black	228725
IP68 CONNECTION BOX, 5-pole	
● black	1006453 ●

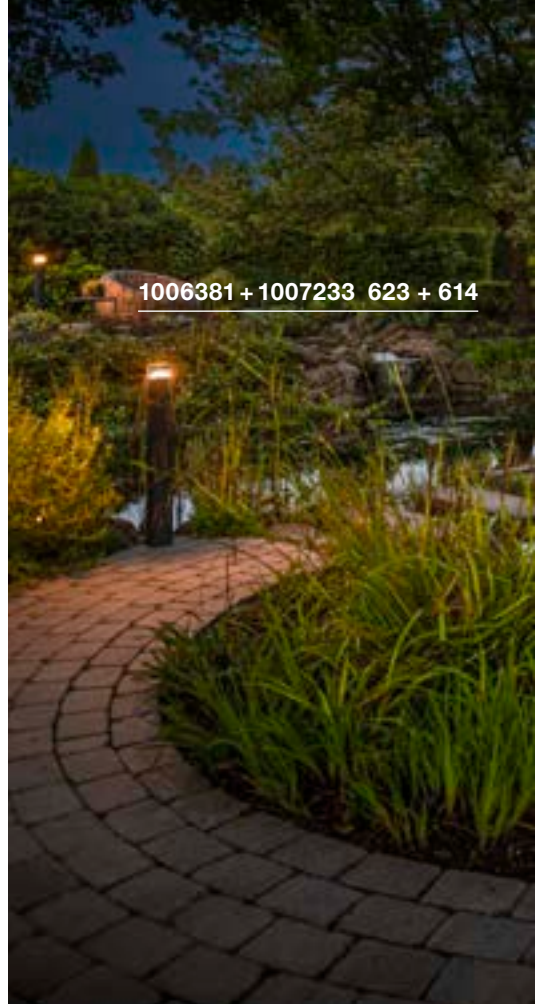

1006381 + 1007233 623 + 614



1006380 + 1007232 623 + 614

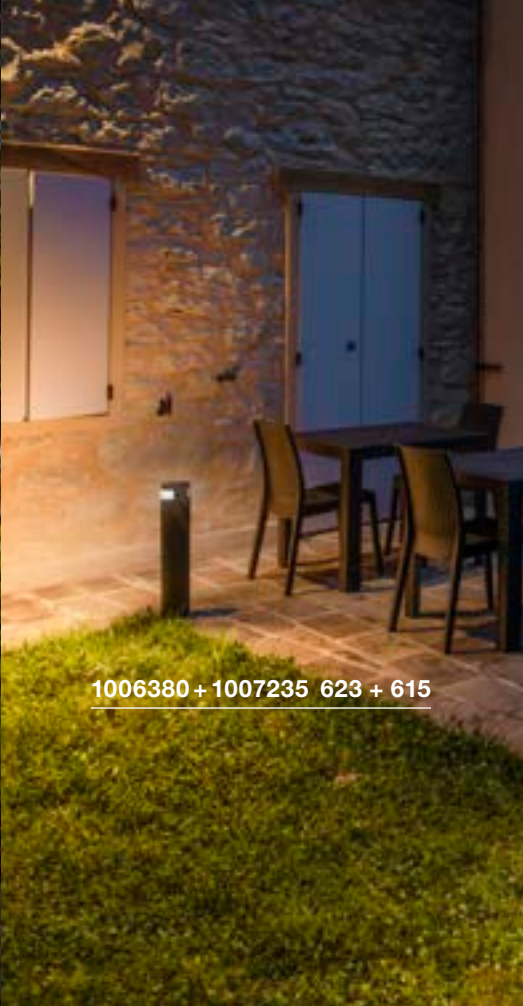

1006380 + 1007235 623 + 615



M-POL S
Polehead 180°, Glare reduction

M-POL S
Polehead 180°, Glare reduction,
DALI

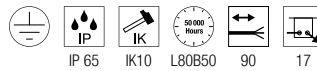
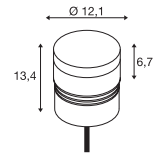
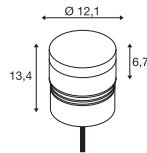

220-240V ~50/60Hz | 500mA
Total wattage: 10W
Material: aluminium



220-240V ~50/60Hz | 500mA
Total wattage: 10W
Material: aluminium



Down 700lm | 2700K



Down 700lm | 2700K

Options	Prod. no.
● anthracite	1007234 ●

Options	Prod. no.
● anthracite	1007235 ●



Product	Prod. no.
pole	
● anthracite	
H: 23.4 cm	1006379
● anthracite	
H: 53.4 cm	1006380
● anthracite	
H: 83.4 cm	1006381
Ground anchor	
● Stainless steel	1006382
T-connector box	
● black	228726
Connection box IP68, 3-pole	
● black	228730



Product	Prod. no.
pole	
● anthracite	
H: 23.4 cm	1006379
● anthracite	
H: 53.4 cm	1006380
● anthracite	
H: 83.4 cm	1006381
Ground anchor	
● Stainless steel	1006382
Connection box	
● black	228725
IP68 CONNECTION BOX, 5-pole	
● black	1006453 ●



1006381 + 1006389 623 + 617



1006381 + 1006393 623 + 617

M-POL S Polehead

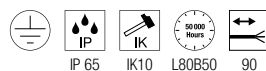
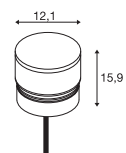

220-240V ~50/60Hz | 500mA
Power consumption: 9W
Total wattage: 11W
Material: aluminium



Down 470lm | 2700K | 510lm | 3000K

Options	Prod. no.
● anthracite	1006383



Product	Prod. no.
---------	-----------

pole	
● anthracite	
H: 23.4 cm	1006379
● anthracite	
H: 53.4 cm	1006380
● anthracite	
H: 83.4 cm	1006381
Ground anchor	
● Stainless steel	1006382
T-connector box	
● black	228726
Connection box IP68, 3-pole	
● black	228730



M-POL S Polehead, DALI

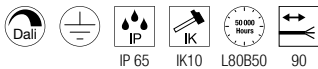
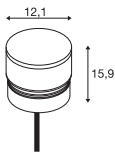

220-240V ~50/60Hz | 500mA
Power consumption: 17W
Total wattage: 19W
Material: aluminium



Down 890lm | 2700K | 950lm | 3000K

Options	Prod. no.
● anthracite	1006389



Product	Prod. no.
pole	
● anthracite H: 23.4 cm	1006379
● anthracite H: 53.4 cm	1006380
● anthracite H: 83.4 cm	1006381
Ground anchor	
● Stainless steel	1006382
Connection box	
● black	228725
IP68 CONNECTION BOX, 5-pole	
● black	1006453 ●

M-POL S Polehead, Shader

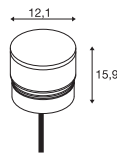

220-240V ~50/60Hz | 500mA
Power consumption: 9W
Total wattage: 11W
Material: aluminium



Down 285lm | 2700K | 310lm | 3000K

Options	Prod. no.
● anthracite	1006387



Product	Prod. no.
pole	
● anthracite H: 23.4 cm	1006379
● anthracite H: 53.4 cm	1006380
● anthracite H: 83.4 cm	1006381
Ground anchor	
● Stainless steel	1006382
T-connector box	
● black	228726
Connection box IP68, 3-pole	
● black	228730

M-POL S Polehead, Shader, DALI

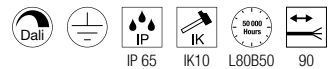
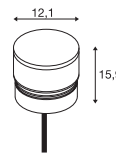

220-240V ~50/60Hz | 500mA
Power consumption: 17W
Total wattage: 19W
Material: aluminium



Down 520lm | 2700K | 550lm | 3000K

Options	Prod. no.
● anthracite	1006393



Product	Prod. no.
pole	
● anthracite H: 23.4 cm	1006379
● anthracite H: 53.4 cm	1006380
● anthracite H: 83.4 cm	1006381
Ground anchor	
● Stainless steel	1006382
Connection box	
● black	228725
IP68 CONNECTION BOX, 5-pole	
● black	1006453 ●

M-POL S
Polehead, Louver

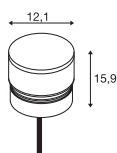

220-240V ~50/60Hz | 500mA
Power consumption: 9W
Total wattage: 11W
Material: aluminium



Down 145lm | 2700K 155lm | 3000K

Options	Prod. no.
● anthracite	1006385



Product	Prod. no.
pole	
● anthracite	
H: 23.4 cm	1006379
● anthracite	
H: 53.4 cm	1006380
● anthracite	
H: 83.4 cm	1006381
Ground anchor	
● Stainless steel	1006382
T-connector box	
● black	228726
Connection box IP68, 3-pole	
● black	228730

M-POL S
Polehead, Louver, DALI

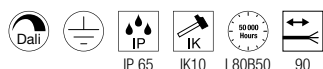
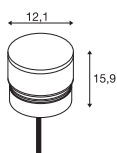

220-240V ~50/60Hz | 500mA
Power consumption: 17W
Total wattage: 19W
Material: aluminium



Down 260lm | 2700K 270lm | 3000K

Options	Prod. no.
● anthracite	1006391



Product	Prod. no.
pole	
● anthracite	
H: 23.4 cm	1006379
● anthracite	
H: 53.4 cm	1006380
● anthracite	
H: 83.4 cm	1006381
Ground anchor	
● Stainless steel	1006382
Connection box	
● black	228725
IP68 CONNECTION BOX, 5-pole	
● black	1006453 ●



1006381 + 1006391 623 + 618



1006381 + 1006388 623 + 619

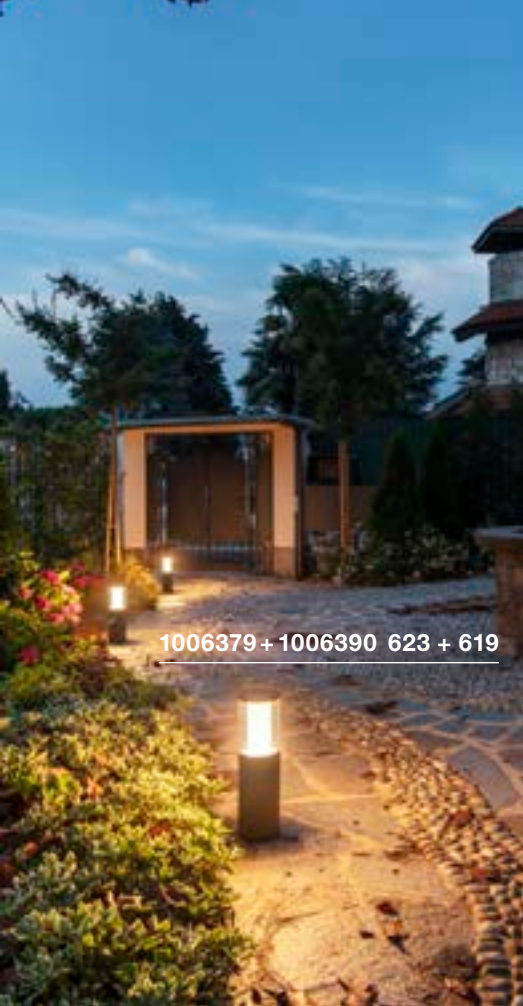

1006379 + 1006390 623 + 619



1006379 + 1006384 623 + 619

M-POL M Polehead

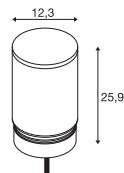

220-240V ~50/60Hz | 500mA
Power consumption: 9W
Total wattage: 11W
Material: aluminium



Down 590lm | 2700K | 660lm | 3000K

Options	Prod. no.
● anthracite	1006384



Product	Prod. no.
pole	
● anthracite H: 23.4 cm	1006379
● anthracite H: 53.4 cm	1006380
● anthracite H: 83.4 cm	1006381
Ground anchor	
● Stainless steel	1006382
T-connector box	
● black	228726
Connection box IP68, 3-pole	
● black	228730

M-POL M Polehead, DALI

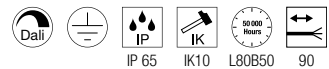
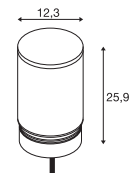

220-240V ~50/60Hz | 500mA
Power consumption: 17W
Total wattage: 19W
Material: aluminium



Down 1150lm | 2700K | 1230lm | 3000K

Options	Prod. no.
● anthracite	1006390



Product	Prod. no.
pole	
● anthracite H: 23.4 cm	1006379
● anthracite H: 53.4 cm	1006380
● anthracite H: 83.4 cm	1006381
Ground anchor	
● Stainless steel	1006382
Connection box	
● black	228725
IP68 CONNECTION BOX, 5-pole	
● black	1006453



M-POL M Polehead, Shader

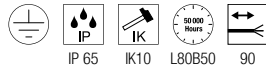
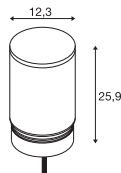
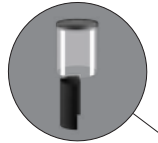

220-240V ~50/60Hz | 500mA
Power consumption: 9W
Total wattage: 11W
Material: aluminium



Down 420lm | 2700K | 460lm | 3000K

Options	Prod. no.
● anthracite	1006388



Product	Prod. no.
pole	
● anthracite H: 23.4 cm	1006379
● anthracite H: 53.4 cm	1006380
● anthracite H: 83.4 cm	1006381
Ground anchor	
● Stainless steel	1006382
T-connector box	
● black	228726
Connection box IP68, 3-pole	
● black	228730

M-POL M Polehead, Shader, DALI

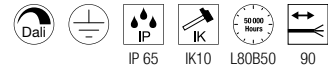
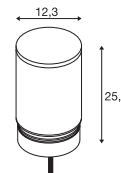

220-240V ~50/60Hz | 500mA
Power consumption: 17W
Total wattage: 19W
Material: aluminium



Down 820lm | 2700K | 870lm | 3000K

Options	Prod. no.
● anthracite	1006394



Product	Prod. no.
pole	
● anthracite H: 23.4 cm	1006379
● anthracite H: 53.4 cm	1006380
● anthracite H: 83.4 cm	1006381
Ground anchor	
● Stainless steel	1006382
Connection box	
● black	228725
IP68 CONNECTION BOX, 5-pole	
● black	1006453

1006381 + 1006388 623 + 620



M-POL M
Polehead, Louver

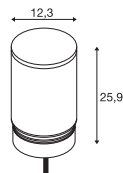

220-240V ~50/60Hz | 500mA
Power consumption: 9W
Total wattage: 11W
Material: aluminium



Down 190lm | 2700K | 210lm | 3000K

Options	Prod. no.
● anthracite	1006386



Product	Prod. no.
pole	
● anthracite H: 23.4 cm	1006379
● anthracite H: 53.4 cm	1006380
● anthracite H: 83.4 cm	1006381
Ground anchor	
● Stainless steel	1006382
T-connector box	
● black	228726
Connection box IP68, 3-pole	
● black	228730

M-POL M
Polehead, Louver, DALI

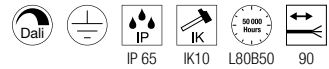
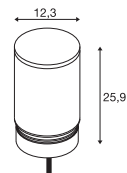

220-240V ~50/60Hz | 500mA
Power consumption: 17W
Total wattage: 19W
Material: aluminium



Down 350lm | 2700K | 370lm | 3000K

Options	Prod. no.
● anthracite	1006392



Product	Prod. no.
pole	
● anthracite H: 23.4 cm	1006379
● anthracite H: 53.4 cm	1006380
● anthracite H: 83.4 cm	1006381
Ground anchor	
● Stainless steel	1006382
Connection box	
● black	228725
IP68 CONNECTION BOX, 5-pole	
● black	1006453

1006381 + 1006392 623 + 621



[1006380](tel:1006380) + [1006392](tel:1006392) - [623](tel:623) + [621](tel:621)



M-POL 30
Pole



M-POL 60
Pole



M-POL 90
Pole

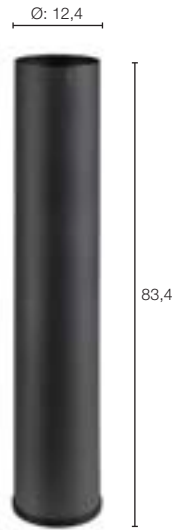

Material: aluminium

Options	Prod. no.
● anthracite	1006379

Material: aluminium

Options	Prod. no.
● anthracite	1006380

Material: aluminium

Options	Prod. no.
● anthracite	1006381



Product	Prod. no.
IP68 CONNECTION BOX, 5-pole	
● black	1006453 ●
T-connector box	
● black	228726
Connection box IP68, 3-pole	
● black	228730



Product	Prod. no.
IP68 CONNECTION BOX, 5-pole	
● black	1006453 ●
T-connector box	
● black	228726
Connection box IP68, 3-pole	
● black	228730



Product	Prod. no.
IP68 CONNECTION BOX, 5-pole	
● black	1006453 ●
T-connector box	
● black	228726
Connection box IP68, 3-pole	
● black	228730

DESIGN YOUR M-POL SYSTEM

The right bollard lights in a few steps – made possible with the M-POL system. It combines three sizes and eight lamp heads with five light properties and two colour temperatures. Whether in high or flat form, with shaders for less light on one side, homogeneous and diffuse radiance or glare-free thanks to integrated louvres. Whether 2700 or 3000 Kelvin, controllable as an On/Off version or DALI. Configure your chosen M-POL bollard lights and showcase every outdoor ambience in its best light.

CHOOSE YOUR PREFERRED ...

- 1 bollard (30, 60, 90)
- 2 Lamp head (On/Off, DALI)
- 3 Lamp head size (high, flat)
- 4 Light property (Clear, Shader, Louver)
- 5 Colour temperature (2700K, 3000K)



DONE!

LAMP HEADS

M-POL S

Diameter: 12.3 cm, H: 15.9 cm

M-POL M

Diameter: 12.3 cm, H: 25.9 cm

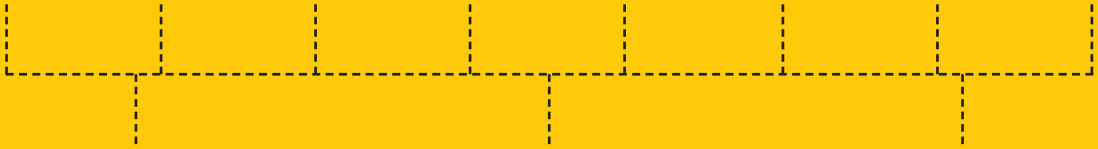
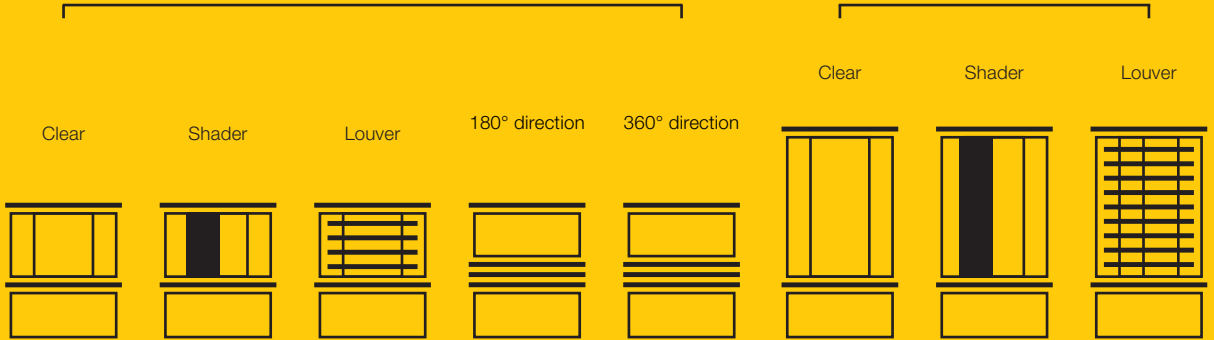

M-POL 30

Diameter: 12.4 cm, H: 23.4 cm

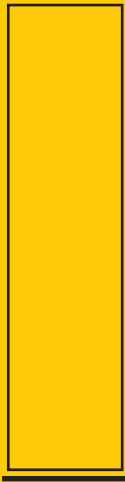

M-POL 60

Diameter: 12.4 cm, H: 53.4 cm

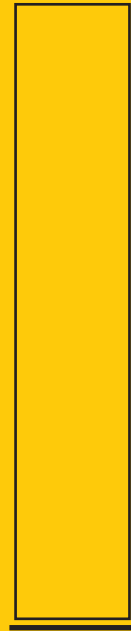

M-POL 90

Diameter: 12.4 cm, H: 83.4 cm

BOLLARDS



1006408 627



CONCRETO
FL, round, QPAR 51

CONCRETO
FL, square, QPAR51

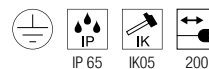
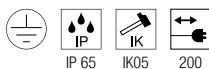
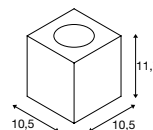
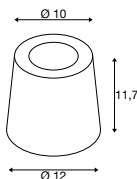

220-240V ~50/60Hz
Material: concrete/aluminium

220-240V ~50/60Hz
Material: concrete/aluminium

- IP44 safety plug

- IP44 contour plug



Base: 1xGU10 Max. diameter: 5.1 cm L: 6 cm

Base: 1xGU10 Max. diameter: 5.1 cm L: 6 cm

Options	Prod. no.
● grey	1006408

Options	Prod. no.
● grey	1006409



LED GU10 51mm | 6W | 38°
2700K | 450lm | EEK=F
6kWh/1000h



Prod. no.: 1005077



LED GU10 51mm | 6W | 38°
2700K | 450lm | EEK=F
6kWh/1000h



Prod. no.: 1005077



1004749 629

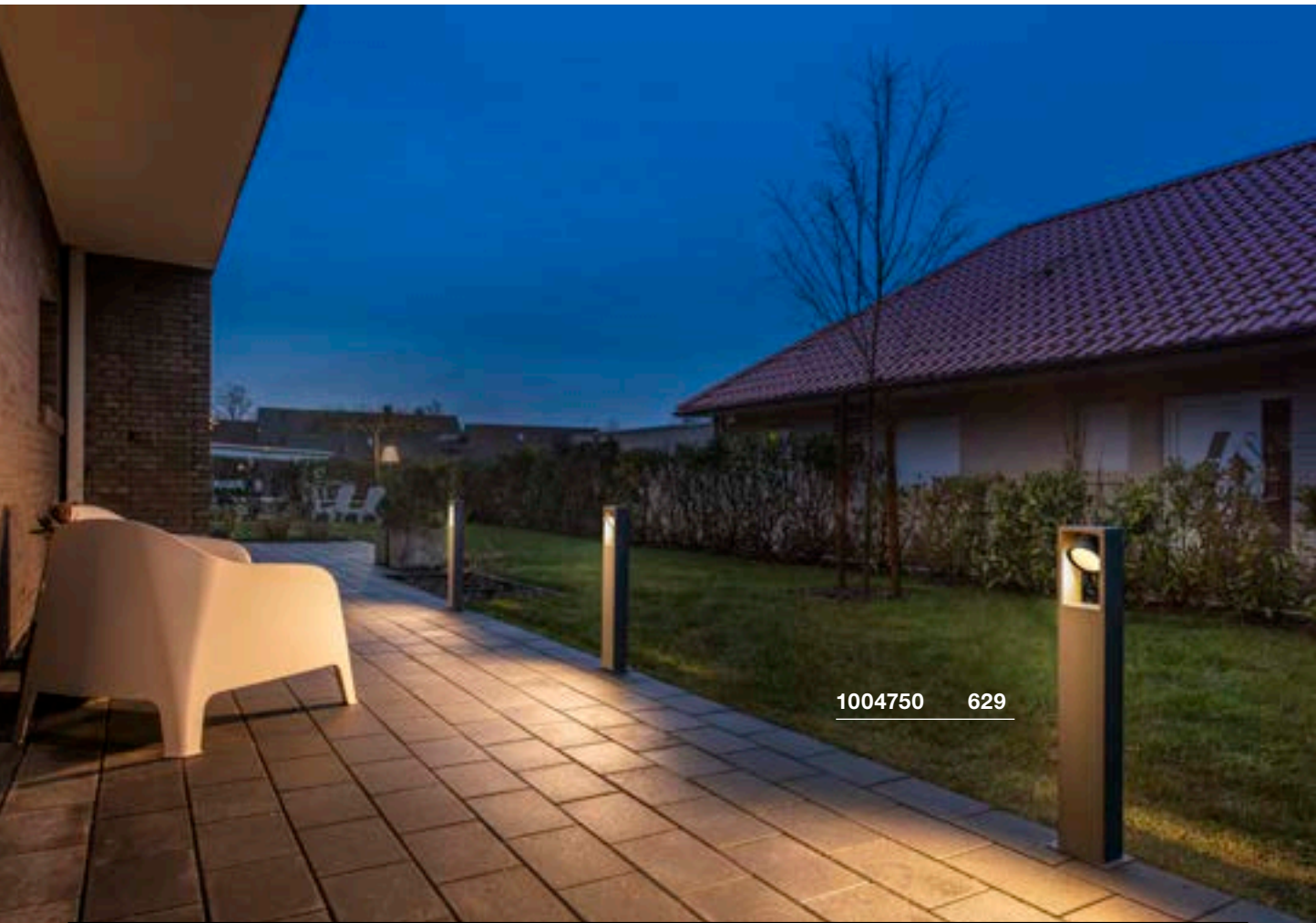

1004750 629



ESKINA FRAME 45 Pole, single

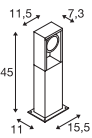

220-240V ~50/60Hz | 350mA
Total wattage: 15W
Material: aluminium



Down 1100lm | 3000K | 1200lm | 4000K

Options	Prod. no.
● anthracite	1004749



Product	Prod. no.
Connection box IP68, 3-pole	
● black	228730

ESKINA FRAME 75 Pole, single

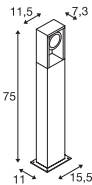

220-240V ~50/60Hz | 350mA
Total wattage: 15W
Material: aluminium



Down 1100lm | 3000K | 1200lm | 4000K

Options	Prod. no.
● anthracite	1004750



Product	Prod. no.
Connection box IP68, 3-pole	
● black	228730

ESKINA FRAME 75 Pole, double

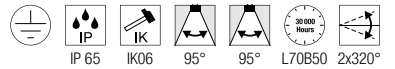
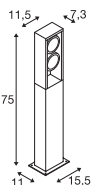

220-240V ~50/60Hz | 700mA
Total wattage: 27W
Material: aluminium



Spot 1 1100lm | 3000K | 1200lm | 4000K
Spot 2 1100lm | 3000K | 1200lm | 4000K

Options	Prod. no.
● anthracite	1004751



Product	Prod. no.
Connection box IP68, 3-pole	
● black	228730

ESKINA FRAME 125
Pole, double

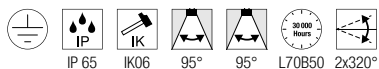
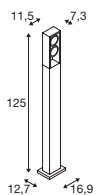

220-240V ~50/60Hz | 700mA
Total wattage: 27W
Material: aluminium



Spot 1	1100lm	3000K	1200lm	4000K
Spot 2	1100lm	3000K	1200lm	4000K

Options	Prod. no.
● anthracite	1005439



Product	Prod. no.
● black	228730

ESKINA FRAME 175
Pole, double

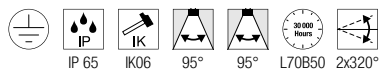
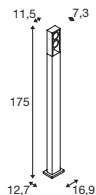

220-240V ~50/60Hz | 700mA
Total wattage: 27W
Material: aluminium



Spot 1	1100lm	3000K	1200lm	4000K
Spot 2	1100lm	3000K	1200lm	4000K

Options	Prod. no.
● anthracite	1005440



Product	Prod. no.
● black	228730

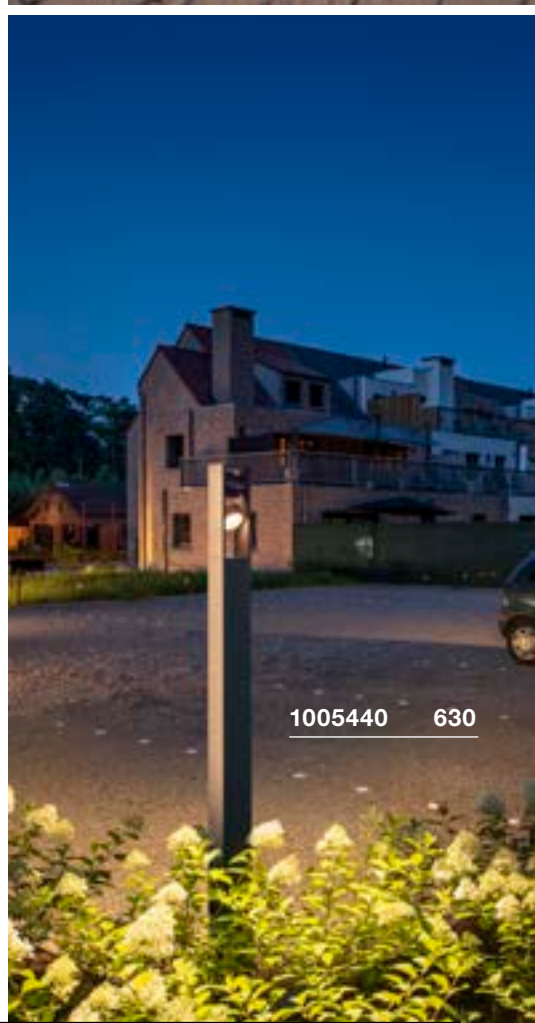
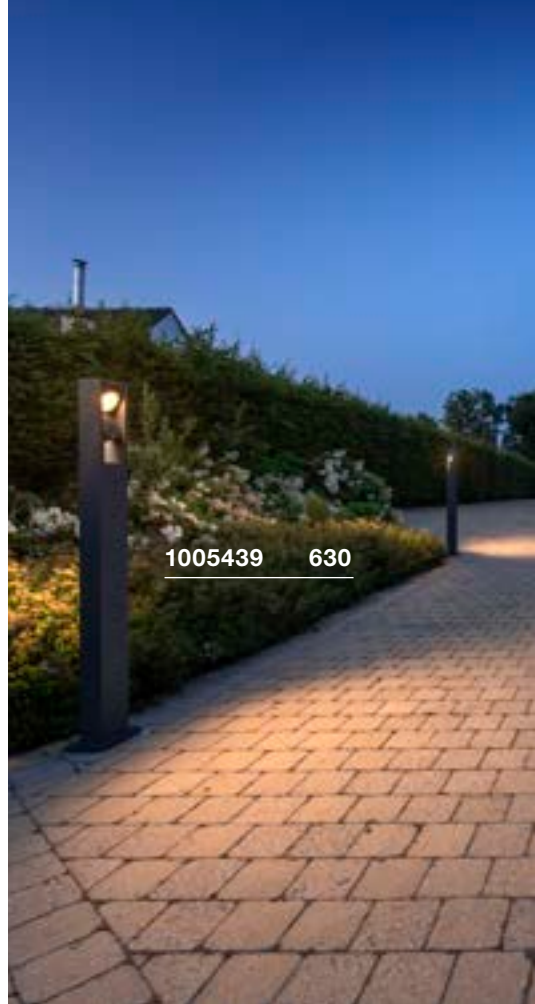

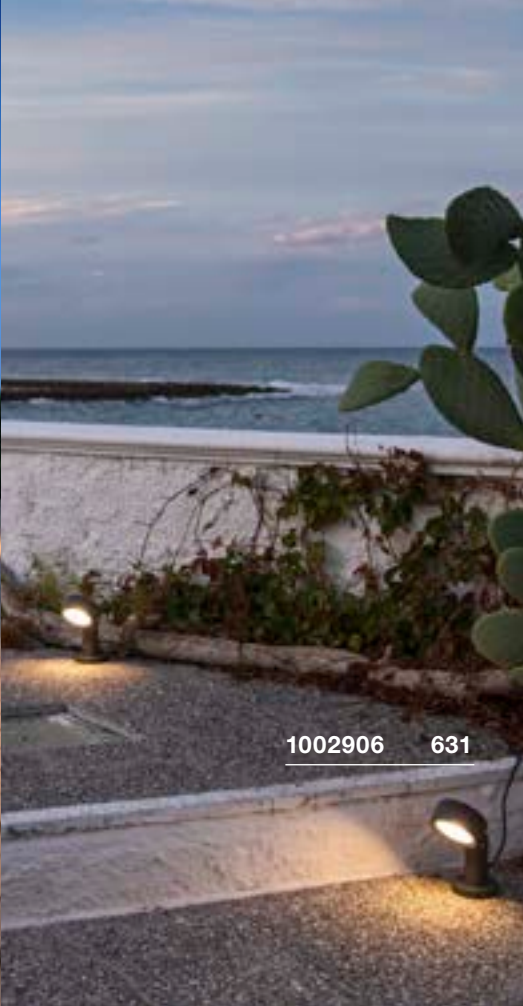

1002906 631



1002907 631

ESKINA 30 Pole

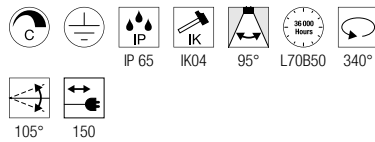
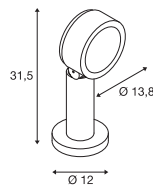

220-240V ~50/60Hz | 350mA
 Total wattage: 14.5W
 Material: aluminium

- IP44 safety plug



Down 1000lm | 3000K | 4000K

Options	Prod. no.
● anthracite	1002906



Product	Prod. no.
Ground spike	
● grey	230060

ESKINA 80 Pole

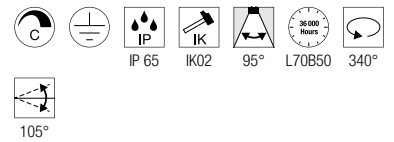
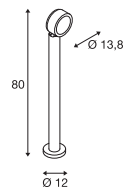

220-240V ~50/60Hz | 350mA
 Total wattage: 14.5W
 Material: aluminium



Down 1000lm | 3000K | 4000K

Options	Prod. no.
● anthracite	1002907



Product	Prod. no.
Ground spike	
● grey	230060
Connection box IP68, 3-pole	
● black	228730



232115

633

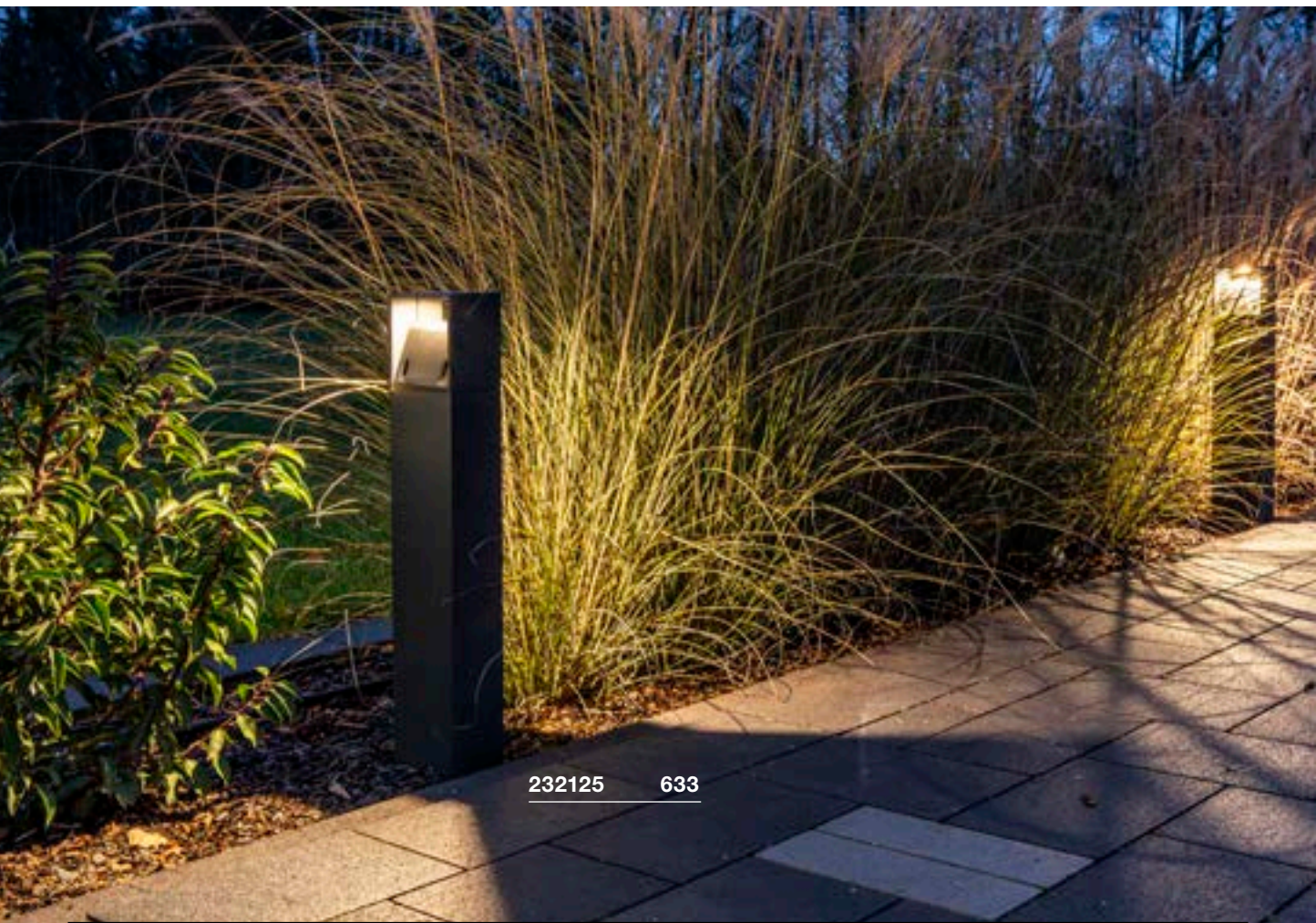

232125

633



LOGS 40 Pole

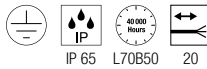
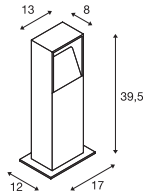

220-240V ~50/60Hz | 500mA
 Total wattage: 9.5W
 Material: aluminium

- Open cable end



Down 570lm | 3000K

Options	Prod. no.
● anthracite	232115



Product	Prod. no.
Concrete anchor	
● grey	232119
Ground spike	
● grey	231230
Screw set	
● Stainless steel	228754
Connection box IP68, 3-pole	
● black	228730

LOGS 70 Pole

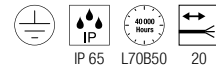
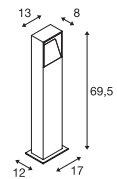

220-240V ~50/60Hz | 500mA
 Total wattage: 9.5W
 Material: aluminium

- Open cable end



Down 570lm | 3000K

Options	Prod. no.
● anthracite	232125



Product	Prod. no.
Concrete anchor	
● grey	232119
Ground spike	
● grey	231230
Screw set	
● Stainless steel	228754
Connection box IP68, 3-pole	
● black	228730



1006180 635

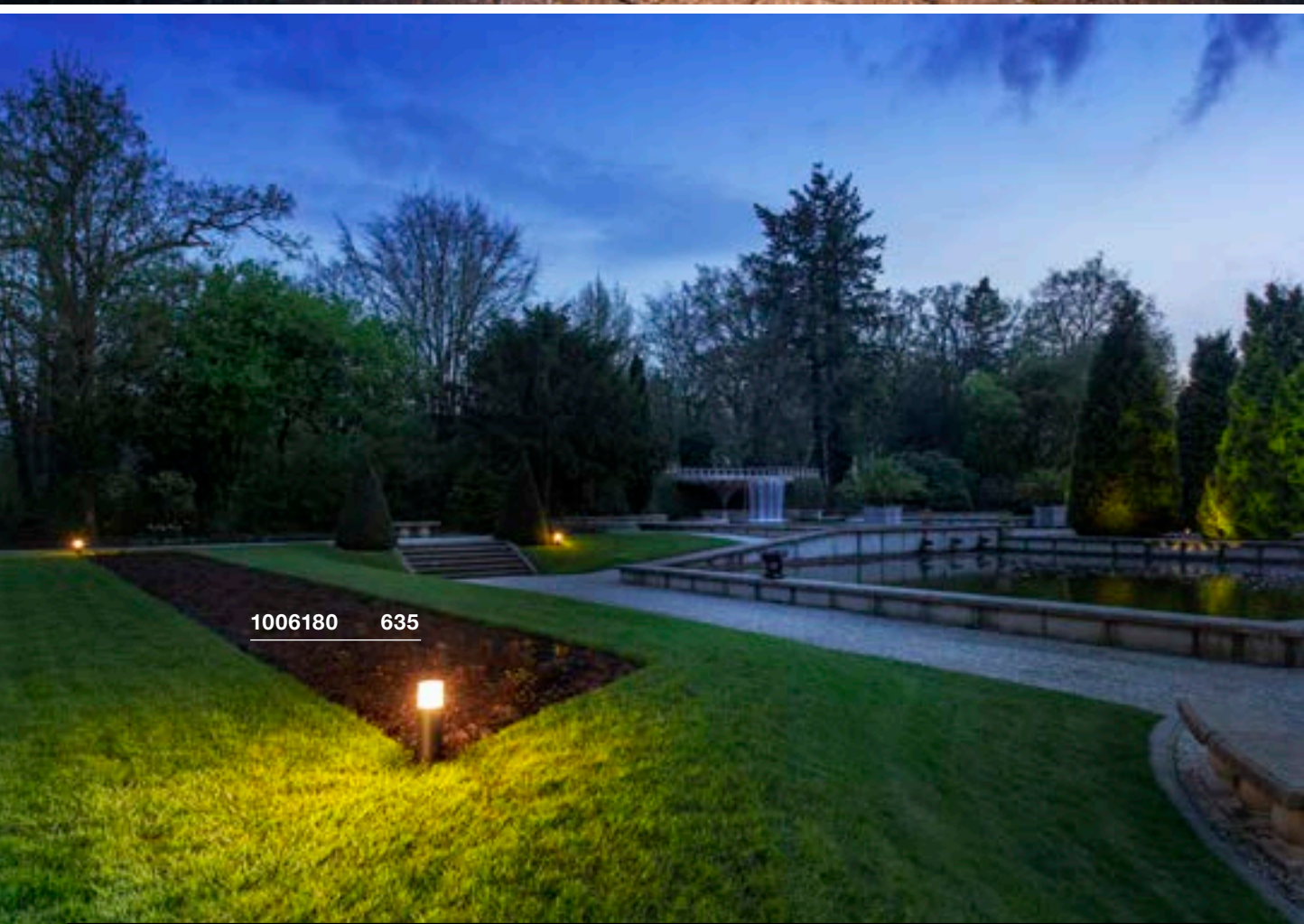

1006180 635



GRAFIT 30
Pole, Round, E27

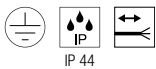
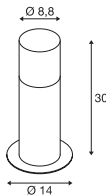

220-240V ~50/60Hz
Material: aluminium/acrylic

- Open cable end



Base: 1xE27 Max. diameter: 6 cm L: 11.5 cm

Options	Prod. no.
● anthracite	1006180



LED E27 | 8W | 240°
3000K | 880lm | EEK=E
8kWh/1000h



Prod. no.: **1005289**



Product	Prod. no.
Connection box IP68, 3-pole	
● black	228730

GRAFIT 60
Pole, Round, E27

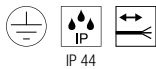
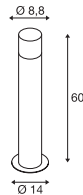

220-240V ~50/60Hz
Material: aluminium/acrylic

- Open cable end



Base: 1xE27 Max. diameter: 6 cm L: 11.5 cm

Options	Prod. no.
● anthracite	1006181



LED E27 | 8W | 240°
3000K | 880lm | EEK=E
8kWh/1000h



Prod. no.: **1005289**



Product	Prod. no.
Connection box IP68, 3-pole	
● black	228730

GRAFIT 90
Pole, Round, E27

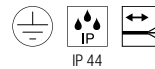
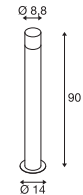

220-240V ~50/60Hz
Material: aluminium/acrylic

- Open cable end



Base: 1xE27 Max. diameter: 6 cm L: 11.5 cm

Options	Prod. no.
● anthracite	1006182



LED E27 | 8W | 240°
3000K | 880lm | EEK=E
8kWh/1000h



Prod. no.: **1005289**



Product	Prod. no.
Connection box IP68, 3-pole	
● black	228730



231225 637



1006184 637



GRAFIT 30
Pole, E27

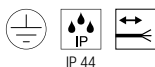
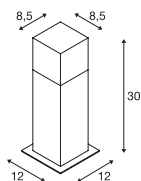

220-240V ~50/60Hz
Material: aluminium/plastic

- Open cable end



Base: 1xE27 Max. diameter: 6 cm L: 11.5 cm

Options	Prod. no.
● anthracite	231215



LED E27 | 8W | 240°
3000K | 880lm | EEK=E
8kWh/1000h

Prod. no.: **1005289**



Product	Prod. no.
Ground spike	
● grey	231230
Screw set	
● Stainless steel	228754
Connection box IP68, 3-pole	
● black	228730

GRAFIT 60
Pole, E27

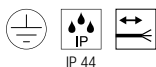
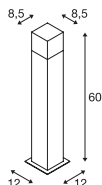

220-240V ~50/60Hz
Material: aluminium/plastic

- Open cable end



Base: 1xE27 Max. diameter: 6 cm L: 11.5 cm

Options	Prod. no.
● anthracite	231225



LED E27 | 8W | 240°
3000K | 880lm | EEK=E
8kWh/1000h

Prod. no.: **1005289**



Product	Prod. no.
Ground spike	
● grey	231230
Screw set	
● Stainless steel	228754
Connection box IP68, 3-pole	
● black	228730

GRAFIT 90
Pole, E27

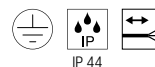
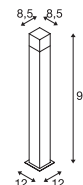

220-240V ~50/60Hz
Material: aluminium/acrylic

- Open cable end



Base: 1xE27 Max. diameter: 6 cm L: 11.5 cm

Options	Prod. no.
● anthracite	1006184



LED E27 | 8W | 240°
3000K | 880lm | EEK=E
8kWh/1000h

Prod. no.: **1005289**



Product	Prod. no.
Ground spike	
● grey	231230
Connection box IP68, 3-pole	
● black	228730



1005442 639



QUADRULO FL

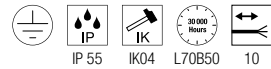
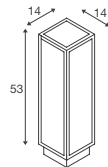

100-277V ~50/60Hz | 480mA
 Total wattage: 7W
 Material: aluminium/acrylic

- IP connection box



Down

340lm | 3000K

Options	Prod. no.
● anthracite	1005442



RUSTY® SLOT 50
Pole

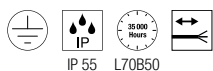
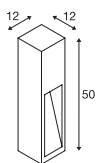

220-240V ~50/60Hz
Total wattage: 9W
Material: FeCSi steel/polycarbonate (PC)

- Open cable end



Down 30lm | 3000K

Options	Prod. no.
● rust	233447



Product	Prod. no.
Ground spike	
● grey	231230
Connection box IP68, 3-pole	
● black	228730

RUSTY® SLOT 80
Pole

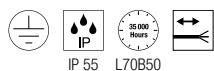
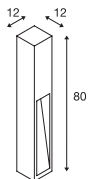

220-240V ~50/60Hz
Total wattage: 9W
Material: FeCSi steel/polycarbonate (PC)

- Open cable end



Down 30lm | 3000K

Options	Prod. no.
● rust	233457



Product	Prod. no.
Ground spike	
● grey	231230
Connection box IP68, 3-pole	
● black	228730



229410 641

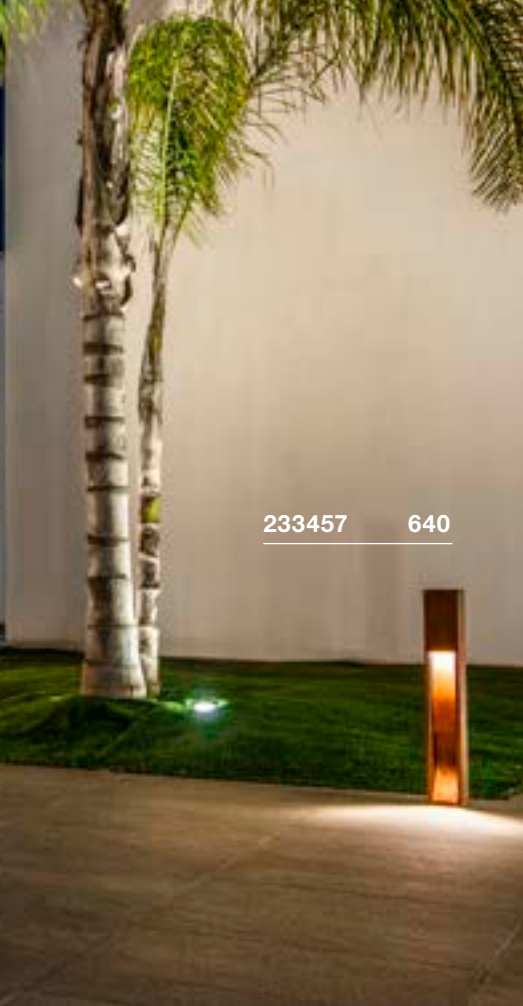

233457 640

RUSTY® SLOT 50
Pole, E27

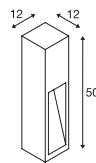

RUSTY® SLOT 80
Pole, E27

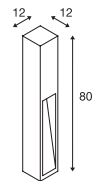

229411 641

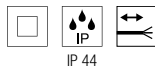

220-240V ~50/60Hz
Material: FeCSi steel/polycarbonate (PC)

- Open cable end



Base: 1xE27 Max. diameter: 4.8 cm L: 13.9 cm

Options	Prod. no.
● rust	229410



LED E27 | 8W | 240°
3000K | 880lm | EEK=E
8kWh/1000h

Prod. no.: 1005289



Product	Prod. no.
Ground spike	
● grey	231230
Connection box IP68, 3-pole	
● black	228730

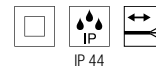

220-240V ~50/60Hz
Material: FeCSi steel/polycarbonate (PC)

- Open cable end



Base: 1xE27 Max. diameter: 4.8 cm L: 13.9 cm

Options	Prod. no.
● rust	229411



LED E27 | 8W | 240°
4000K | 920lm | EEK=E
8kWh/1000h

Prod. no.: 1005290



Product	Prod. no.
Ground spike	
● grey	231230
Connection box IP68, 3-pole	
● black	228730



233090 642



229420 643

RUSTY® PATHLIGHT Pole, TCR-TSE

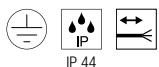
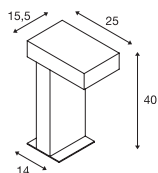

220-240V ~50/60Hz
Material: FeCSi steel/polycarbonate (PC)

- Open cable end



Base: 1xG53 Max. diameter: 7.5 cm L: 2.7 cm

Options	Prod. no.
● rust	230090



LED GX53 | 6.1W | 120°
3000K | 490lm | EEK=G
6kWh/1000h



Prod. no.: 1005271



Product	Prod. no.
Ground spike	
● grey	229422
Connection box IP68, 3-pole	
● black	228730

RUSTY® 40 Pole

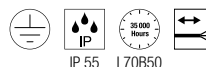
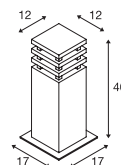

220-240V ~50/60Hz
Total wattage: 9W
Material: FeCSi steel/polycarbonate (PC)

- Open cable end



Down 90lm | 3000K

Options	Prod. no.
● rust	233427



Product	Prod. no.
Ground spike	
● grey	229422
Connection box IP68, 3-pole	
● black	228730



RUSTY® 70
Pole

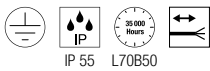
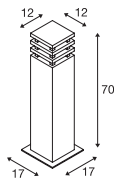

220-240V ~50/60Hz
Total wattage: 9W
Material: FeCSi steel/polycarbonate (PC)

- Open cable end



Down 90lm | 3000K

Options	Prod. no.
● rust	233437

Product	Prod. no.
Ground spike	
● grey	229422
Connection box IP68, 3-pole	
● black	228730

RUSTY® 40
Pole, E27

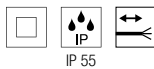
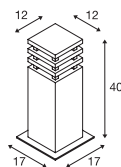

220-240V ~50/60Hz
Material: FeCSi steel/polycarbonate (PC)

- Open cable end



Base: 1xE27 Max. diameter: 4.8 cm L: 13.9 cm

Options	Prod. no.
● rust	229420

LED E27 | 8W | 240°
 3000K | 880lm | EEK=E
 8kWh/1000h

Prod. no.: 1005289

Product	Prod. no.
Ground spike	
● grey	229422
Connection box IP68, 3-pole	
● black	228730

RUSTY® 70
Pole, E27

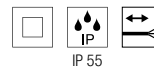
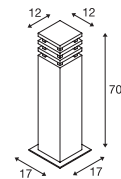

220-240V ~50/60Hz
Material: FeCSi steel/polycarbonate (PC)

- Open cable end



Base: 1xE27 Max. diameter: 4.8 cm L: 13.9 cm

Options	Prod. no.
● rust	229421

LED E27 | 8W | 240°
 4000K | 920lm | EEK=E
 8kWh/1000h

Prod. no.: 1005290

Product	Prod. no.
Ground spike	
● grey	229422
Connection box IP68, 3-pole	
● black	228730

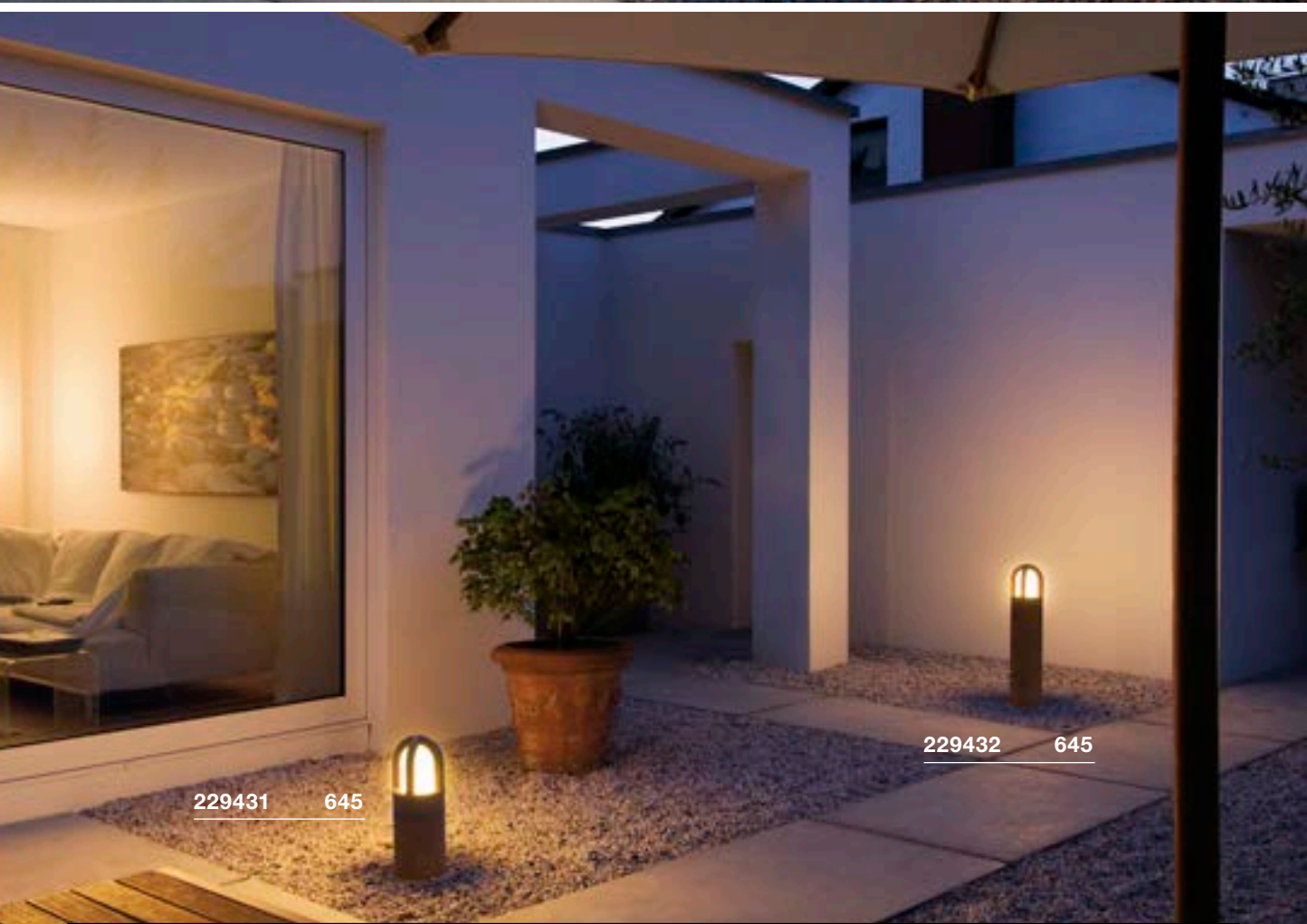



RUSTY® CONE 24
FL, E14

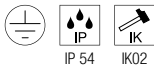
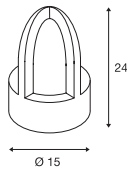

220-240V ~50/60Hz
Material: FeCSi steel/glass



Base: 1xE14 Max. diameter: 4.8 cm L: 13.9 cm

Options	Prod. no.
● rust	229430



C35 | 4.2W | 320°
2700K | 350lm | EEK=G
5kWh/1000h

Prod. no.: 1005285



RUSTY® CONE 40
Pole, E27

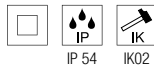
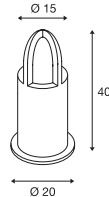

220-240V ~50/60Hz
Material: FeCSi steel/glass



Base: 1xE27 Max. diameter: 4.8 cm L: 13.9 cm

Options	Prod. no.
● rust	229431



LED E27 | 8W | 240°
3000K | 880lm | EEK=E
8kWh/1000h

Prod. no.: 1005289



Product	Prod. no.
Ground spike	
● grey	229422
Connection box IP68, 3-pole	
● black	228730

RUSTY® CONE 70
Pole, E27

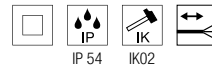
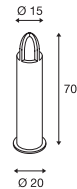

220-240V ~50/60Hz
Material: FeCSi steel/polycarbonate (PC)



Base: 1xE27 Max. diameter: 4.8 cm L: 13.9 cm

Options	Prod. no.
● rust	229432



LED E27 | 8W | 240°
3000K | 880lm | EEK=E
8kWh/1000h

Prod. no.: 1005289



Product	Prod. no.
Ground spike	
● grey	229422
Connection box IP68, 3-pole	
● black	228730

RUSTY® 40
Pole, E27

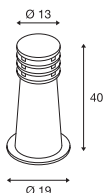

RUSTY® 70
Pole, E27

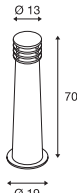

229020 646

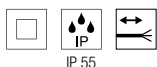

220-240V ~50/60Hz
Material: FeCSi steel/polycarbonate (PC)

- Open cable end



Base: 1xE27 Max. diameter: 4.8 cm L: 13.9 cm

Options	Prod. no.
● rust	229020



LED E27 | 8W | 240°
4000K | 920lm | EEK=E
8kWh/1000h



Prod. no.: 1005290



Product	Prod. no.
Ground spike	
● Stainless steel	229022
Connection box IP68, 3-pole	
● black	228730

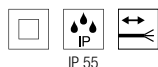

220-240V ~50/60Hz
Material: FeCSi steel/polycarbonate (PC)

- Open cable end



Base: 1xE27 Max. diameter: 4.8 cm L: 13.9 cm

Options	Prod. no.
● rust	229021



LED E27 | 8W | 240°
3000K | 880lm | EEK=E
8kWh/1000h



Prod. no.: 1005289



Product	Prod. no.
Ground spike	
● Stainless steel	229022
Connection box IP68, 3-pole	
● black	228730

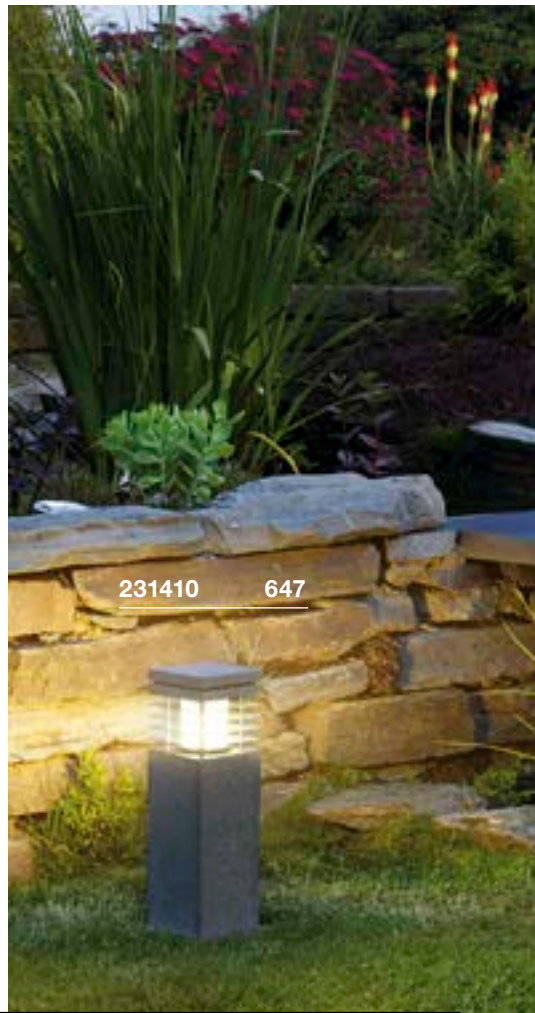

231410 647



229021 646



231411 647

ARROCK GRANITE 40
Pole, square, E27

ARROCK GRANITE 70
Pole, square, E27

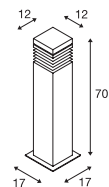
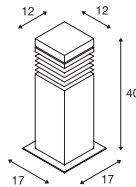

220-240V ~50/60Hz
Material: granite/stainless steel 304



220-240V ~50/60Hz
Material: granite/stainless steel 304



Base: 1xE27 Max. diameter: 5.2 cm L: 11.5 cm



Base: 1xE27 Max. diameter: 5.2 cm L: 11.5 cm

Options	Prod. no.
● grey	231410

Options	Prod. no.
● grey	231411



LED E27 | 8W | 240°
3000K | 880lm | EEK=E
8kWh/1000h

Prod. no.: 1005289



LED E27 | 8W | 240°
4000K | 920lm | EEK=E
8kWh/1000h

Prod. no.: 1005290



Product	Prod. no.
Ground spike	
● Stainless steel	229022
Connection box IP68, 3-pole	
● black	228730

Product	Prod. no.
Ground spike	
● Stainless steel	229022
Connection box IP68, 3-pole	
● black	228730

ARROCK ARC
Pole, QPAR51

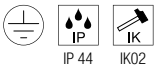
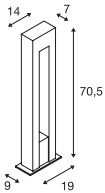

220-240V ~50/60Hz
Material: granite/stainless steel 304



Base: 1xGU10 Max. diameter: 5.1 cm | L: 7.6 cm

Options	Prod. no.
● grey	231420

 LED GU10 51mm | 6W | 38°
 2700K | 450lm | EEK=F
 6kWh/1000h

Prod. no.: 1005075



Product	Prod. no.
Ground spike	
● grey	231233

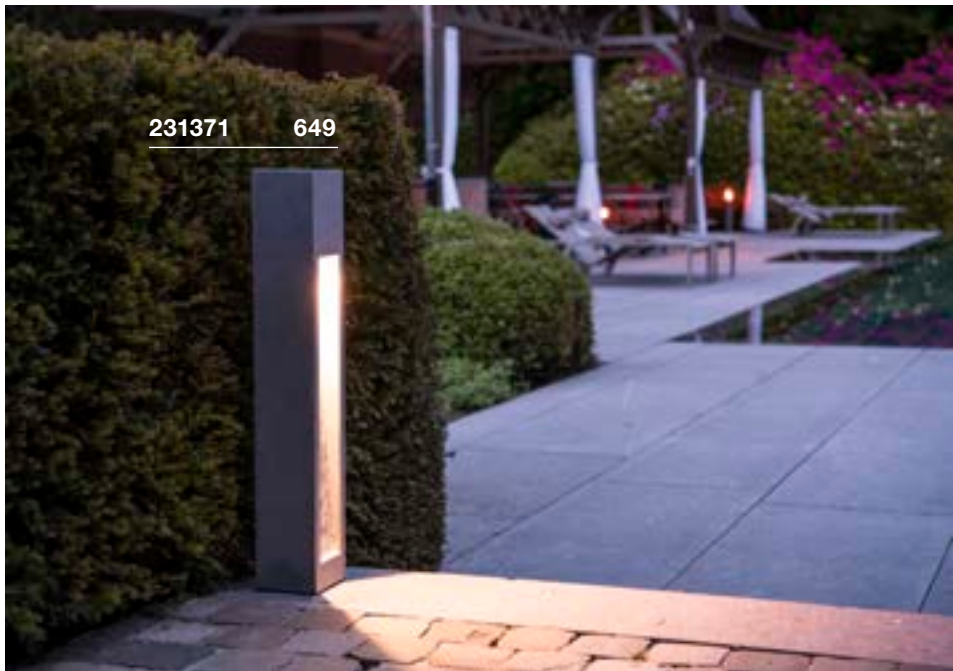



ARROCK STONE 50 Pole

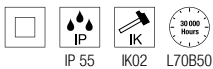
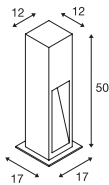

220-240V ~50/60Hz | 700mA
Total wattage: 9W
Material: basalt/stainless steel 304



Down 330lm | 3000K

Options	Prod. no.
● grey	231370

Product	Prod. no.
Ground spike	
● grey	231233

ARROCK STONE 75 Pole

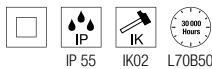
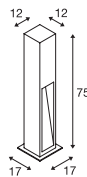

220-240V ~50/60Hz | 700mA
Total wattage: 9W
Material: basalt/stainless steel 304



Down 330lm | 3000K

Options	Prod. no.
● grey	231371

Product	Prod. no.
Ground spike	
● grey	231233

ARROCK SLOT Pole, QPAR51

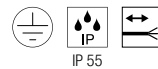
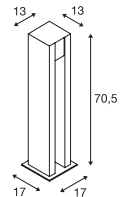

220-240V ~50/60Hz
Material: granite/stainless steel 304
• Open cable end



Base: 1xGU10

Options	Prod. no.
● grey	231440

LED GU10 51mm | 6W | 38°
2700K | 450lm | EEK=F
6kWh/1000h
Prod. no.: 1005076

Product	Prod. no.
Ground spike	
● grey	231235
Connection box IP68, 3-pole	
● black	228730



1003535 651

L-LINE OUT 30 FL, vertical

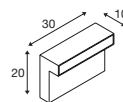

1003538 651



220-240V ~50/60Hz | 500mA
Total wattage: 11.5W
Material: aluminium/polycarbonate (PC)

- The light colour must be set prior to installation
- Open cable end



CRI
80

Down 800lm | 3000K | 810lm | 4000K

Options	Prod. no.
● anthracite	1003536



Product	Prod. no.
Connection box IP68, 3-pole	
● black	228730



L-LINE OUT 60
FL, vertical

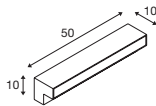

220-240V ~50/60Hz | 500mA
Total wattage: 11.5W
Material: aluminium/polycarbonate (PC)

- The light colour must be set prior to installation
- Open cable end



Down 780lm | 3000K | 800lm | 4000K

Options	Prod. no.
● anthracite	1003535



Product	Prod. no.
Connection box IP68, 3-pole	
● black	228730

L-LINE OUT 50
Pole, horizontal

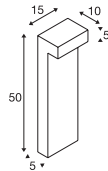

220-240V ~50/60Hz | 350mA
Total wattage: 7W
Material: aluminium/polycarbonate (PC)

- The light colour must be set prior to installation
- Open cable end



Down 490lm | 3000K | 530lm | 4000K

Options	Prod. no.
● anthracite	1003537



Product	Prod. no.
Connection box IP68, 3-pole	
● black	228730

L-LINE OUT 80
Pole, horizontal

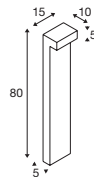

220-240V ~50/60Hz | 350mA
Total wattage: 7W
Material: aluminium/polycarbonate (PC)

- The light colour must be set prior to installation
- Open cable end



Down 490lm | 3000K | 530lm | 4000K

Options	Prod. no.
● anthracite	1003538



Product	Prod. no.
Connection box IP68, 3-pole	
● black	228730

THEO PATHLIGHT

Pole, double

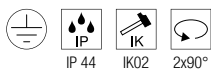
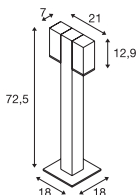

220-240V ~50/60Hz
Material: aluminium



Base: 2xGU10

Options	Prod. no.
● anthracite	1002871



LED GU10 51mm | 6W | 38°
2700K | 450lm | EEK=F
6kWh/1000h



Prod. no.: 1005077



Product	Prod. no.
Connection box IP68, 3-pole	
● black	228730

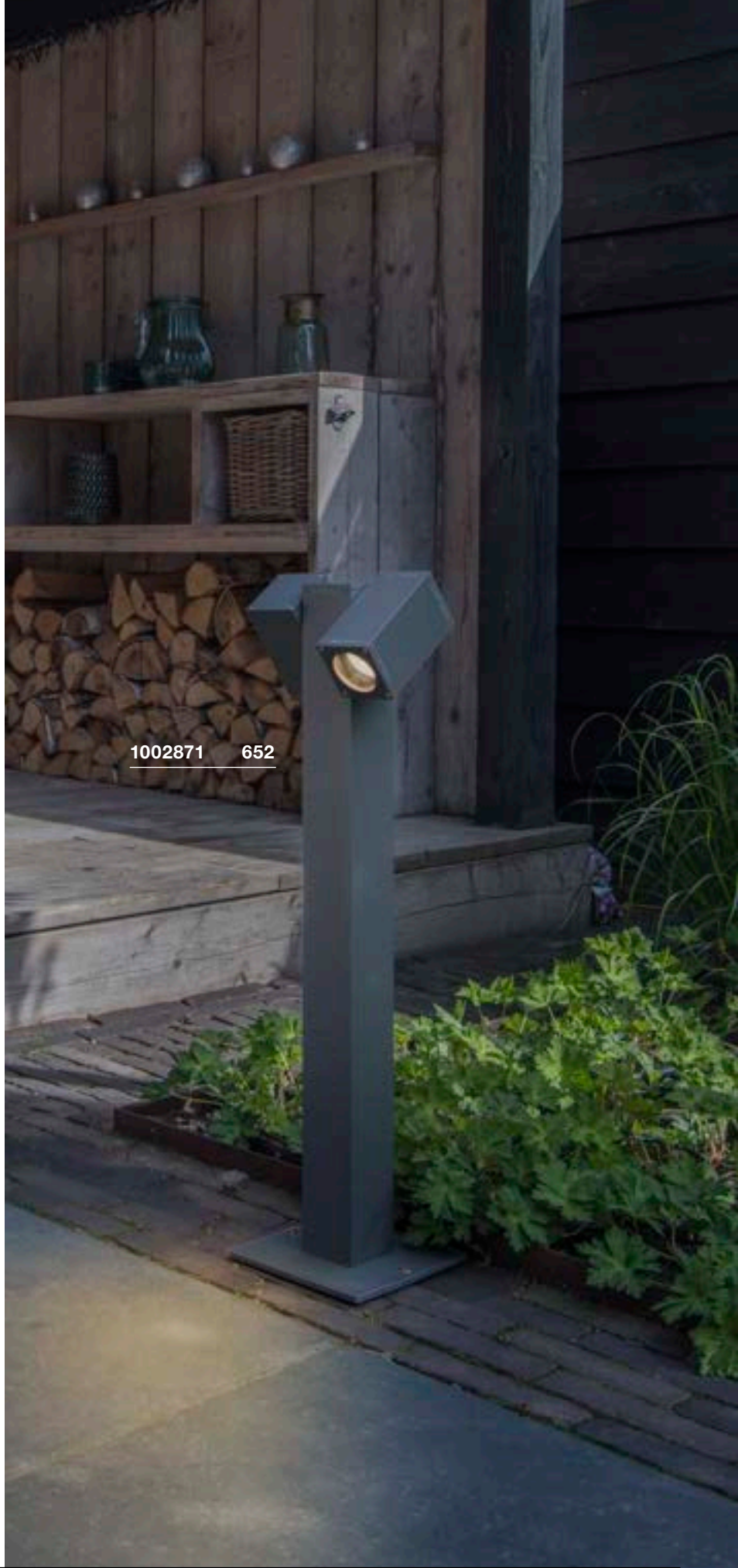

1002871 652



OVALISK 75 Pole

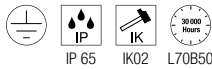
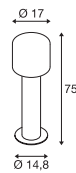

220-240V ~50/60Hz | 500mA
 Total wattage: 9.2W
 Material: aluminium/glass



Down 580lm | 3000K | 630lm | 4000K

Options	Prod. no.
● anthracite	1004680



Product	Prod. no.
Concrete anchor	
○ silver	228712
Ground spike	
● grey	228722
Connection box IP68, 3-pole	
● black	228730

OVALISK 100 Pole

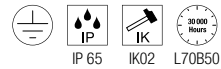
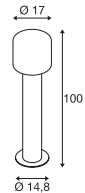

220-240V ~50/60Hz | 500mA
 Total wattage: 9.2W
 Material: aluminium/glass



Down 580lm | 3000K | 630lm | 4000K

Options	Prod. no.
● anthracite	1004681

1004680 653



1002000 655

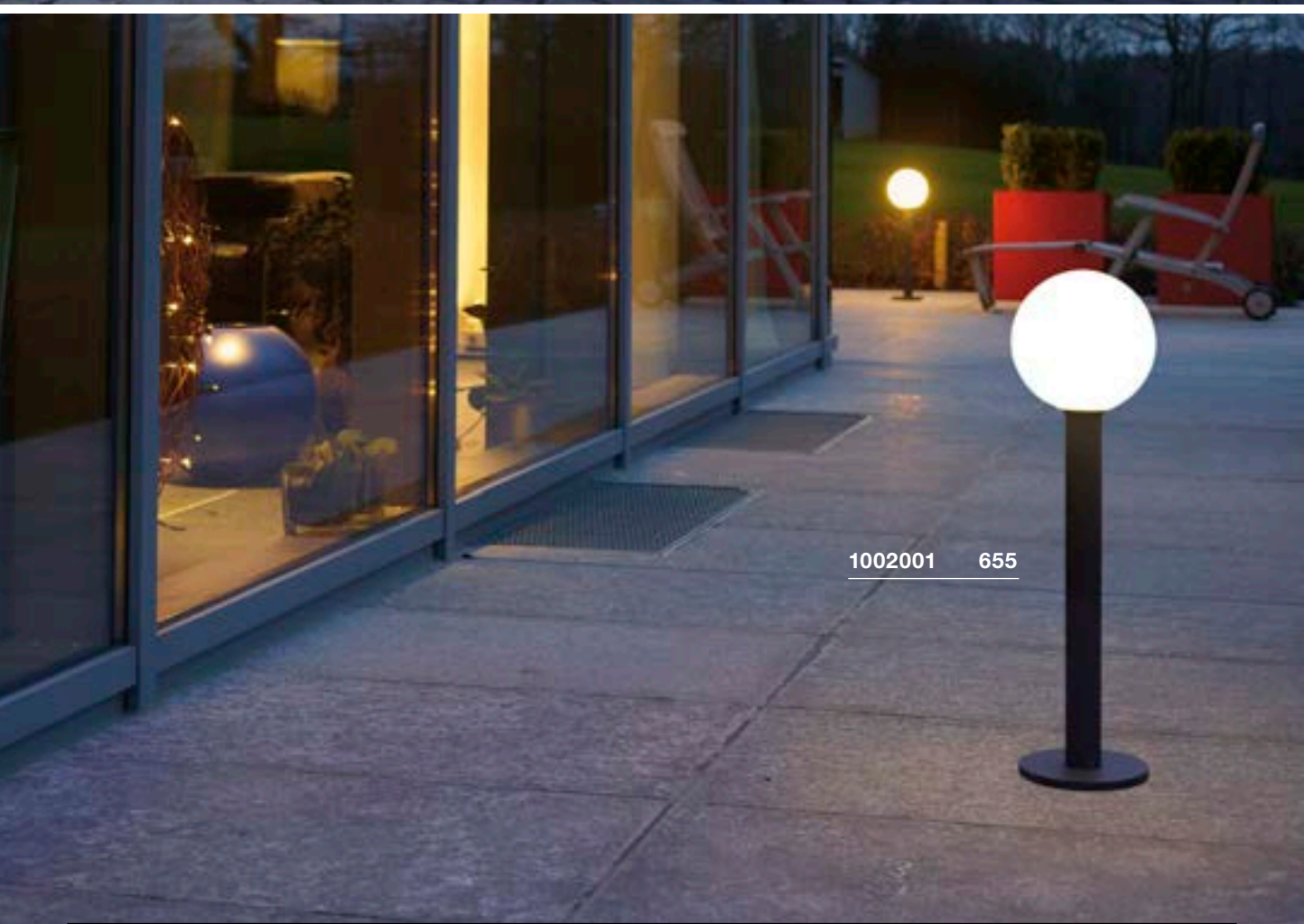

1002001 655



GLOO PURE 27
Pole, E27

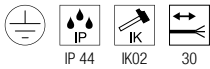
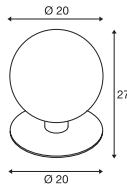

220-240V ~50/60Hz
Material: aluminium/glass

- Open cable end



Base: 1xE27 Max. diameter: 4.8 cm L: 18 cm

Options	Prod. no.
● anthracite	1001999

| 13.5W | 240°
3000K | 1520lm | EEK=E
14kWh/1000h

Prod. no.: 1005307

Product	Prod. no.
Ground spike	
● grey	231234
Connection box IP68, 3-pole	
● black	228730

GLOO PURE 44
Pole, E27

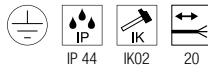
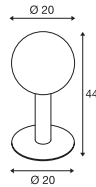

220-240V ~50/60Hz
Material: aluminium/glass

- Open cable end



Base: 1xE27 Max. diameter: 4.8 cm L: 18 cm

Options	Prod. no.
● anthracite	1002000

| LED E27 | 8W | 240°
3000K | 880lm | EEK=E
8kWh/1000h

Prod. no.: 1005289

Product	Prod. no.
Ground spike	
● grey	231234
Connection box IP68, 3-pole	
● black	228730

GLOO PURE 70
Pole, E27

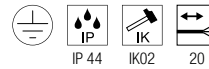
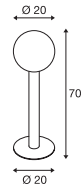

220-240V ~50/60Hz
Material: aluminium/glass

- Open cable end



Base: 1xE27 Max. diameter: 4.8 cm L: 18 cm

Options	Prod. no.
● anthracite	1002001

| 13.5W | 240°
3000K | 1520lm | EEK=E
14kWh/1000h

Prod. no.: 1005307

Product	Prod. no.
Ground spike	
● grey	231234
Connection box IP68, 3-pole	
● black	228730



227221 657

227219 657



ROTOBALL 25
FL, E27

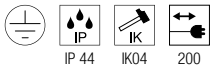
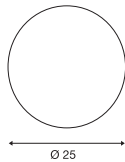

220-240V ~50/60Hz
Material: steel/polyethylene (PE)

- IP44 contour plug



Base: 1xE27

Options	Prod. no.
<input type="radio"/> white	227219



A60 | 7.5W | 320°
2700K | 800lm | EEK=F
8kWh/1000h

Prod. no.: 1005303



ROTOBALL 40
FL, E27

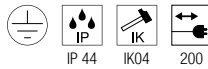
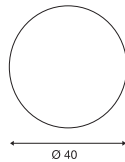

220-240V ~50/60Hz
Material: steel/polyethylene (PE)

- IP44 safety plug



Base: 1xE27

Max. diameter: 9.5 cm

Options	Prod. no.
<input type="radio"/> white	227220



LED E27 | 8W | 240°
3000K | 880lm | EEK=E
8kWh/1000h

Prod. no.: 1005289



ROTOBALL 50
FL, E27

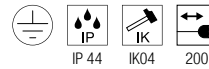
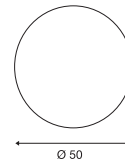

220-240V ~50/60Hz
Material: steel/polyethylene (PE)

- IP44 safety plug



Base: 1xE27

Max. diameter: 9.5 cm

Options	Prod. no.
<input type="radio"/> white	227221



A60 | 7.5W | 320°
2700K | 800lm | EEK=F
8kWh/1000h

Prod. no.: 1005303





232065 659

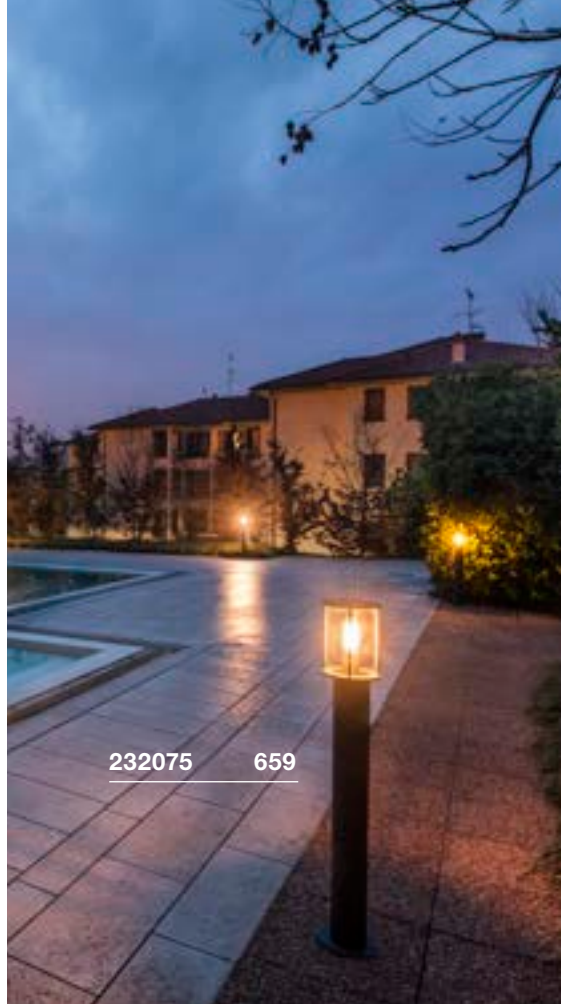

232075 659

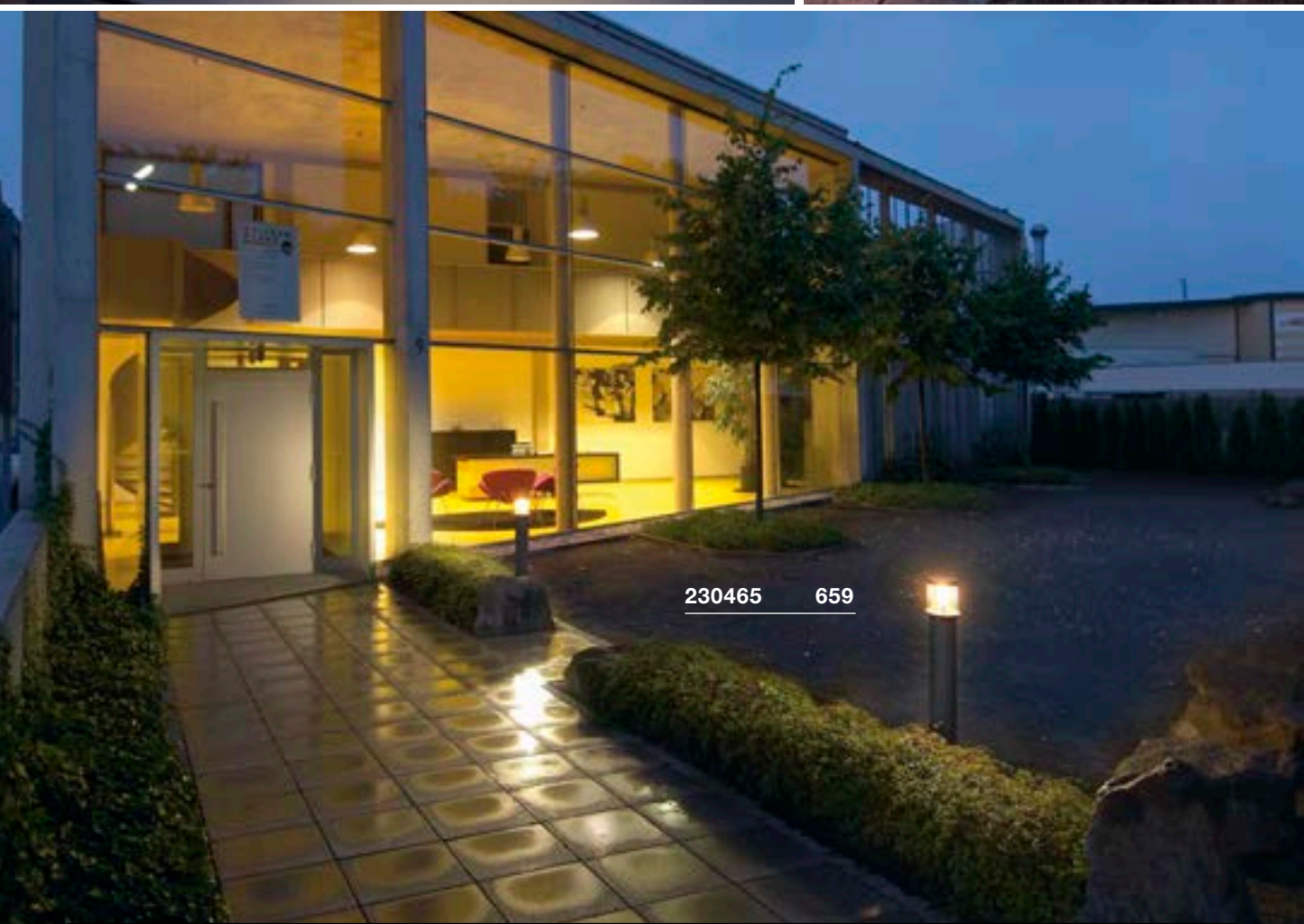

230465 659



PHOTONIA
PD, E27

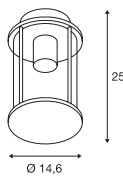

220-240V ~50/60Hz
Material: aluminium/glass

- Suspension chain included
- IP44 safety plug



Base: 1xE27 Max. diameter: 9 cm L: 15 cm

Options	Prod. no.
● anthracite	232065



LED E27 | 7.5W | 320°
2700K | 800lm | EEK=F
8kWh/1000h



Prod. no.: 1005268



Product	Prod. no.
Ceiling rosette	
● anthracite	1000398

PHOTONIA
Pole, E27

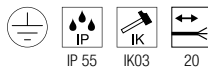

220-240V ~50/60Hz
Material: aluminium/glass

- Open cable end



Base: 1xE27 Max. diameter: 9 cm L: 15 cm

Options	Prod. no.
● anthracite	232075



LED E27 | 7.5W | 320°
2500K | 700lm | EEK=F
8kWh/1000h



Prod. no.: 1005265



Product	Prod. no.
Concrete anchor	
● Stainless steel	232085
Connection box IP68, 3-pole	
● black	228730

OTOS GLAS
Pole, E27

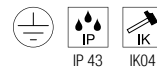
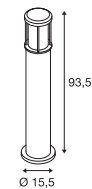

220-240V ~50/60Hz
Material: aluminium/glass

- Concrete anchor included



Base: 1xE27 Max. diameter: 6.5 cm L: 14.5 cm

Options	Prod. no.
● anthracite	230465



A60 | 7.5W | 320°
2700K | 800lm | EEK=F
8kWh/1000h



Prod. no.: 1005303



Product	Prod. no.
Screw set	
● Stainless steel	228753
Connection box IP68, 3-pole	
● black	228730

CUBIX
FL, QPAR51

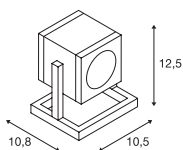

220-240V ~50/60Hz
Material: aluminium/glass

- IP44 safety plug



Base: 1xGU10

Options	Prod. no.
● anthracite	132835

LED GU10 51mm | 6W | 38°
2700K | 450lm | EEK=F
6kWh/1000h

Prod. no.: 1005077



CONE
FL, E27

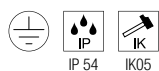
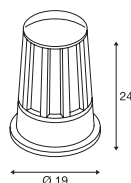

220-240V ~50/60Hz
Material: aluminium/glass



Base: 1xE27 max. L: 15 cm

Options	Prod. no.
● anthracite	230435

LED E27 | 7.5W | 320°
2500K | 700lm | EEK=F
8kWh/1000h

Prod. no.: 1005265







1000821 661

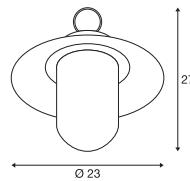

1000822 661

MOLAT
PD, E27



220-240V ~50/60Hz
Material: aluminium/glass

- Suspension chain included
- IP44 safety plug



Base: 1xE27 Max. diameter: 6.5 cm L: 14.5 cm

Options	Prod. no.
● anthracite	1000821



LED E27 | 7.5W | 320°
2700K | 800lm | EEK=F
8kWh/1000h



Prod. no.: 1005268



Product	Prod. no.
Ceiling rosette	
● anthracite	1000398

MOLAT
Pole, E27

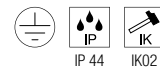
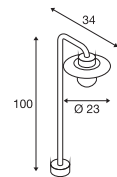

220-240V ~50/60Hz
Material: aluminium/glass



Base: 1xE27 Max. diameter: 6.5 cm L: 14.5 cm

Options	Prod. no.
● anthracite	1000822



LED E27 | 7.5W | 320°
2500K | 700lm | EEK=F
8kWh/1000h



Prod. no.: 1005265



Product	Prod. no.
Ground spike	
● grey	230060

LISENNE 40
Pole, E27

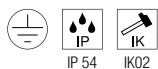
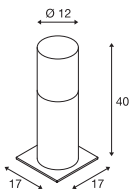

220-240V ~50/60Hz
Material: basalt/glass



Base: 1xE27 Max. diameter: 5.9 cm L: 15 cm

Options

Prod. no.

- grey

1000665



LED E27 | 7.5W | 320°
2700K | 800lm | EEK=F
8kWh/1000h



Prod. no.: 1005268



Product

Prod. no.

Ground spike

- grey

229422

LISENNE 70
Pole, E27

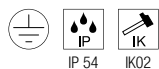
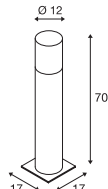

220-240V ~50/60Hz
Material: basalt/glass



Base: 1xE27 Max. diameter: 5.9 cm L: 15 cm

Options

Prod. no.

- grey

1000666



LED E27 | 7.5W | 320°
2700K | 800lm | EEK=F
8kWh/1000h



Prod. no.: 1005268



Product

Prod. no.

Ground spike

- grey

229422

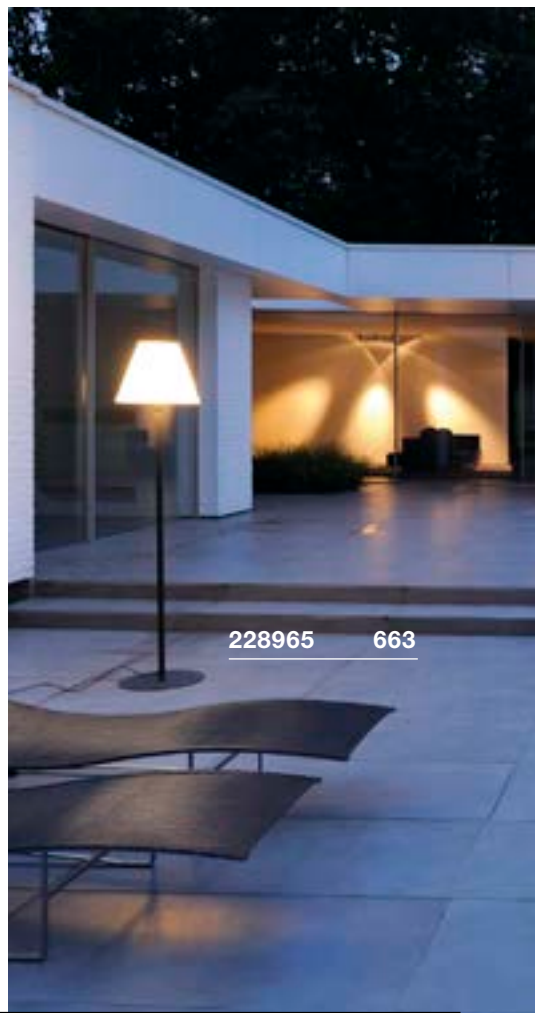

228965

663



ADEGAN MANILA
FL, E27

ADEGAN
FL, E27

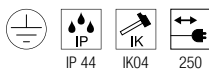
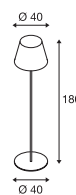
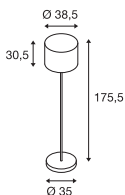

220-240V ~50/60Hz
Material: granite/stainless steel

- IP44 safety plug



Base: 1xE27 Max. diameter: 4.8 cm L: 18 cm

Options	Prod. no.
● stainless steel/ anthracite	1002494



LED E27 | 8W | 240°
3000K | 880lm | EEK=E
8kWh/1000h

Prod. no.: 1005289

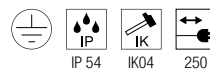

220-240V ~50/60Hz
Material: aluminium/polycarbonate (PC)

- IP44 safety plug



Base: 1xE27 Max. diameter: 5.2 cm

Options	Prod. no.
● anthracite	228965



LED E27 | 8W | 240°
3000K | 880lm | EEK=E
8kWh/1000h

Prod. no.: 1005289



Product	Prod. no.
Ground spike	
● anthracite	228960



228935 665



228925 665



ALPA MUSHROOM 45
Pole, E27

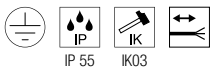
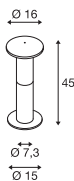

220-240V ~50/60Hz
Material: aluminium/polycarbonate (PC)

- Open cable end



Base: 1xE27 Max. diameter: 5.2 cm L: 16 cm

Options	Prod. no.
● anthracite	228935



LED E27 | 8W | 240°
3000K | 880lm | EEK=E
8kWh/1000h



Prod. no.: 1005289



Product	Prod. no.
Concrete anchor	
○ silver	228712
Ground spike	
● grey	228722
Connection box IP68, 3-pole	
● black	228730

ALPA MUSHROOM 75
Pole, E27

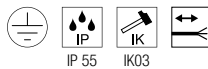
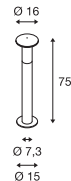

220-240V ~50/60Hz
Material: aluminium/polycarbonate (PC)

- Open cable end



Base: 1xE27 Max. diameter: 5.2 cm L: 16 cm

Options	Prod. no.
● anthracite	228945



LED E27 | 8W | 240°
3000K | 880lm | EEK=E
8kWh/1000h



Prod. no.: 1005289



Product	Prod. no.
Concrete anchor	
○ silver	228712
Ground spike	
● grey	228722
Connection box IP68, 3-pole	
● black	228730

ALPA CONE 100
Pole, E27

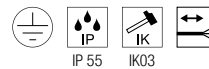
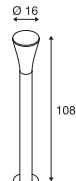

220-240V ~50/60Hz
Material: aluminium/polycarbonate (PC)

- Open cable end



Base: 1xE27 Max. diameter: 5.2 cm L: 17.5 cm

Options	Prod. no.
● anthracite	228925



| 13.5W | 240°
3000K | 1520lm | EEK=E
14kWh/1000h



Prod. no.: 1005307



Product	Prod. no.
Concrete anchor	
○ silver	228712
Ground spike	
● grey	228722
Connection box IP68, 3-pole	
● black	228730

APONI 90
Pole, PHASE

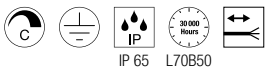
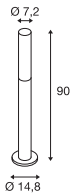

220-240V ~50/60Hz | 500mA
Total wattage: 6.3W
Material: aluminium

- Open cable end



Down 520lm | 3000K

Options	Prod. no.
● anthracite	1000682



Product	Prod. no.
Connection box IP68, 3-pole	
● black	228730

APONI 120
Pole, PHASE

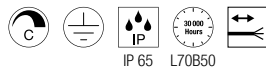
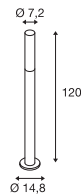

220-240V ~50/60Hz | 500mA
Total wattage: 6.3W
Material: aluminium

- Open cable end



Down 520lm | 3000K

Options	Prod. no.
● anthracite	1000683



Product	Prod. no.
Connection box IP68, 3-pole	
● black	228730



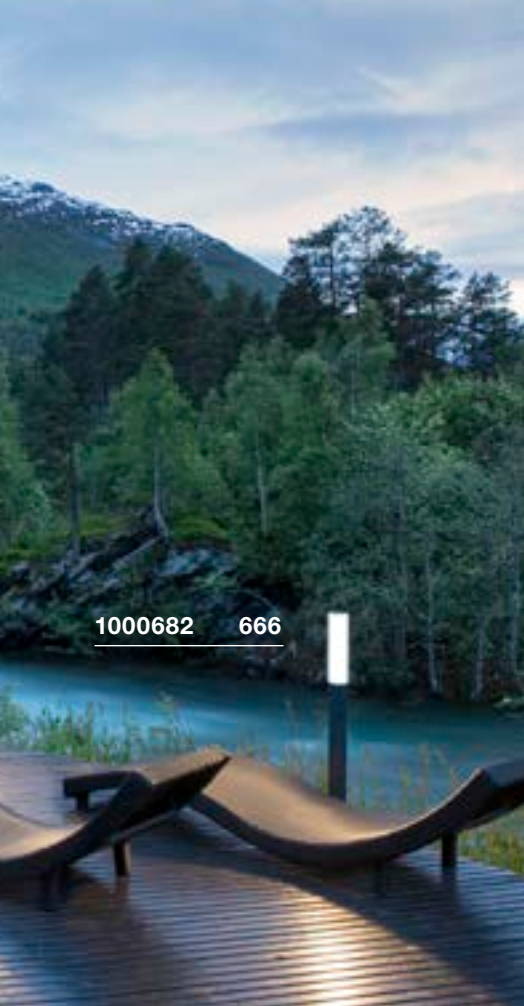

1000682 666

TRUST 30
Pole

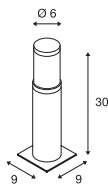

220-240V ~50/60Hz
Total wattage: 9W
Material: stainless steel 316



Down 400lm | 3000K

Options	Prod. no.
● Stainless steel	228100



Product	Prod. no.
Ground spike	
● black	227922
Ring-shaped grid	
● Stainless steel	228130
Connection box IP68, 3-pole	
● black	228730

228110 667



TRUST 60
Pole

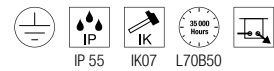
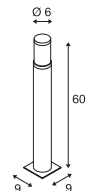

220-240V ~50/60Hz
Total wattage: 9W
Material: stainless steel 316



Down 400lm | 3000K

Options	Prod. no.
● Stainless steel	228110



Product	Prod. no.
Ground spike	
● black	227922
Ring-shaped grid	
● Stainless steel	228130
Connection box IP68, 3-pole	
● black	228730

BIG NAILS 50
POLE, E27

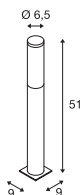

220-240V ~50/60Hz
Material: stainless steel 304/
polycarbonate (PC)



Base: 1xE27 Max. diameter: 4.5 cm L: 17 cm

Options

Prod. no.

- Stainless steel **229162**



LED E27 | 8W | 240°
3000K | 880lm | EEK=E
8kWh/1000h



Prod. no.: 1005289



Product

Prod. no.

- Ground spike
- black **227922**

BIG NAILS 80
POLE, E27

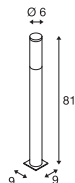

220-240V ~50/60Hz
Material: stainless steel 304/
polycarbonate (PC)



Base: 1xE27 Max. diameter: 4.5 cm L: 17 cm

Options

Prod. no.

- Stainless steel **229172**



| 13.5W | 240°
3000K | 1520lm | EEK=E
14kWh/1000h



Prod. no.: 1005307



Product

Prod. no.

- Ground spike
- black **227922**

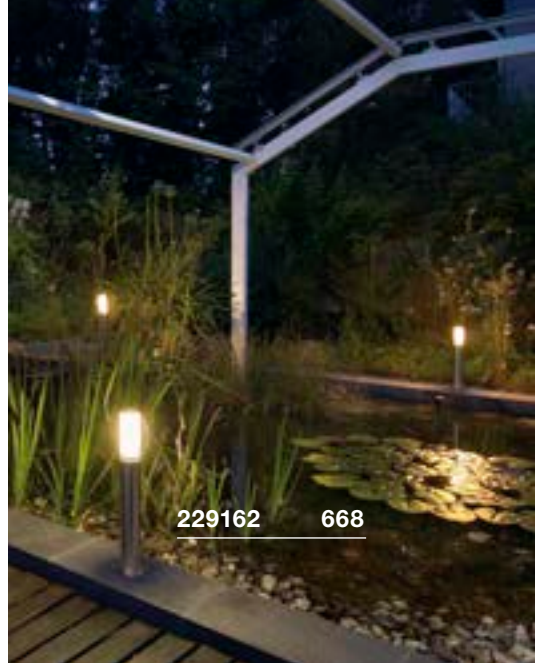



ROX ACRYL 30

Pole, E27

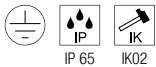
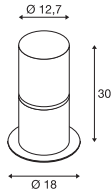

220-240V ~50/60Hz
Material: stainless steel 304



Base: 1xE27 Max. diameter: 6 cm L: 15 cm

Options	Prod. no.
● Stainless steel	1001488



LED E27 | 8W | 240°
3000K | 880lm | EEK=E
8kWh/1000h



Prod. no.: 1005289



Product	Prod. no.
Concrete anchor	
● Stainless steel	1001494
Ground spike	
● grey	231234
T-connector box	
● black	228726

ROX ACRYL 60

Pole, E27

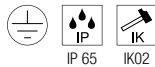
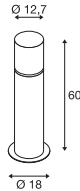

220-240V ~50/60Hz
Material: stainless steel 304



Base: 1xE27 Max. diameter: 6 cm L: 15 cm

Options	Prod. no.
● Stainless steel	1001489



LED E27 | 8W | 240°
3000K | 880lm | EEK=E
8kWh/1000h



Prod. no.: 1005289



Product	Prod. no.
Concrete anchor	
● Stainless steel	1001494
Ground spike	
● grey	231234
T-connector box	
● black	228726

ROX ACRYL 90

Pole, E27

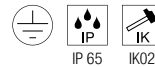
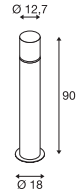

220-240V ~50/60Hz
Material: stainless steel 304



Base: 1xE27 Max. diameter: 6 cm L: 15 cm

Options	Prod. no.
● Stainless steel	1001490



| 13.5W | 240°
3000K | 1520lm | EEK=E
14kWh/1000h



Prod. no.: 1005307



Product	Prod. no.
Concrete anchor	
● Stainless steel	1001494
Ground spike	
● grey	231234
T-connector box	
● black	228726



230066 671



23006 671



VAP SLIM 30
Pole, E27

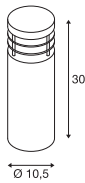

220-240V ~50/60Hz
Material: stainless steel 304



Base: 1xE27 Max. diameter: 5.1 cm L: 12.6 cm

Options	Prod. no.
● Stainless steel	230063



LED E27 | 8W | 240°
3000K | 880lm | EEK=E
8kWh/1000h



Prod. no.: 1005289



Product	Prod. no.
Concrete anchor	
● Stainless steel	230061
Ground spike	
● grey	230060

VAP SLIM 60
Pole, E27



220-240V ~50/60Hz
Material: stainless steel 304



Base: 1xE27 Max. diameter: 5.1 cm L: 12.6 cm

Options	Prod. no.
● Stainless steel	230066



LED E27 | 8W | 240°
4000K | 920lm | EEK=E
8kWh/1000h



Prod. no.: 1005290



Product	Prod. no.
Concrete anchor	
● Stainless steel	230061
Ground spike	
● grey	230060

VAP SLIM 90
Pole, E27

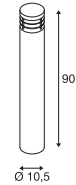

220-240V ~50/60Hz
Material: stainless steel 304



Base: 1xE27 Max. diameter: 5.1 cm L: 12.6 cm

Options	Prod. no.
● Stainless steel	230069



LED E27 | 8W | 240°
3000K | 880lm | EEK=E
8kWh/1000h



Prod. no.: 1005289



Product	Prod. no.
Concrete anchor	
● Stainless steel	230061
Ground spike	
● grey	230060

C-POL
POLE, E27

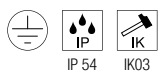
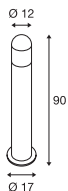

220-240V ~50/60Hz
Material: aluminium/polycarbonate (PC)



Base: 1xE27 Max. diameter: 5.2 cm L: 17.3 cm

Options	Prod. no.
● anthracite	231475

| 13.5W | 240°
 3000K | 1520lm | EEK=E
 14kWh/1000h

Prod. no.: 1005307

Product	Prod. no.
Connection box IP68, 3-pole	
● black	228730

F-POL
POLE, E27

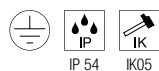
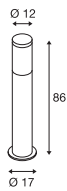

220-240V ~50/60Hz
Material: aluminium/polycarbonate (PC)



Base: 1xE27 Max. diameter: 5.1 cm L: 14.8 cm

Options	Prod. no.
● anthracite	231595

LED E27 | 8W | 240°
 3000K | 880lm | EEK=E
 8kWh/1000h

Prod. no.: 1005289

Product	Prod. no.
Connection box IP68, 3-pole	
● black	228730

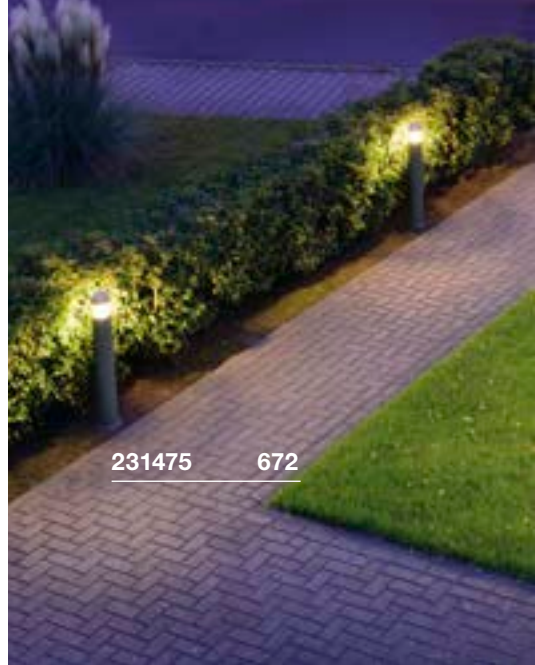

231475 672

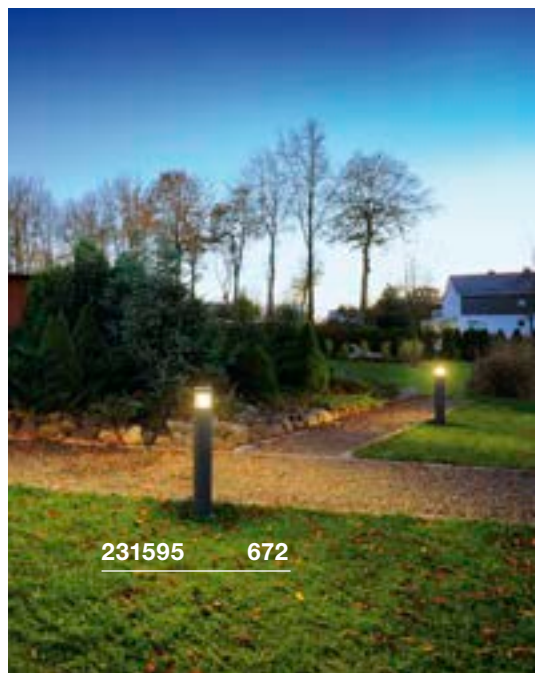

231595 672

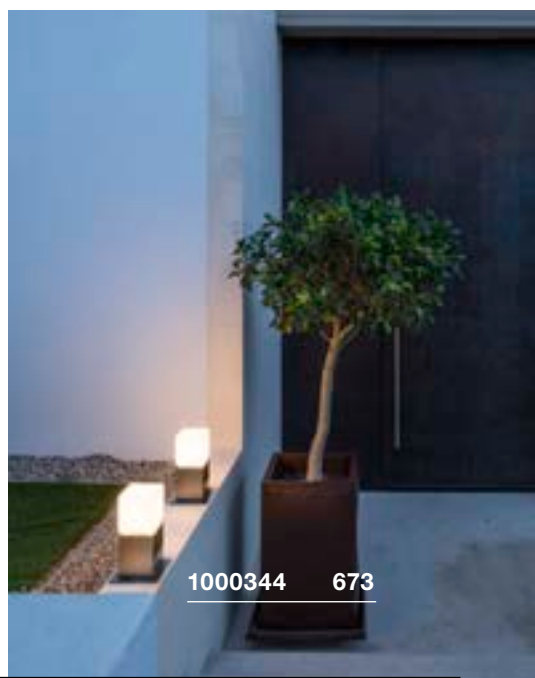

1000344 673



SQUARE POLE 30

Pole, E27

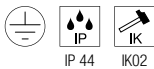
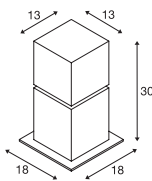

220-240V ~50/60Hz
Material: stainless steel 304



Base: 1xE27 Max. diameter: 6 cm L: 15 cm

Options Prod. no.

- Stainless steel **1000344**



LED E27 | 8W | 240°
3000K | 880lm | EEK=E
8kWh/1000h



Prod. no.: **1005289**



Product Prod. no.

- Concrete anchor
- Stainless steel **1000343**
- Ground spike
- grey **231234**
- Connection box IP68, 3-pole
- black **228730**

SQUARE POLE 60

Pole, E27

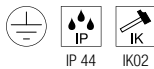
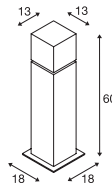

220-240V ~50/60Hz
Material: stainless steel 304



Base: 1xE27 Max. diameter: 6 cm L: 15 cm

Options Prod. no.

- Stainless steel **1000345**



| 13.5W | 240°
3000K | 1520lm | EEK=E
14kWh/1000h



Prod. no.: **1005307**



Product Prod. no.

- Concrete anchor
- Stainless steel **1000343**
- Ground spike
- grey **231234**
- Connection box IP68, 3-pole
- black **228730**

SQUARE POLE 90

Pole, E27

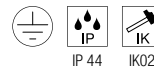
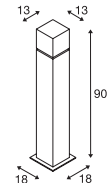

220-240V ~50/60Hz
Material: stainless steel 304



Base: 1xE27 Max. diameter: 6 cm L: 15 cm

Options Prod. no.

- Stainless steel **1000346**



| 13.5W | 240°
3000K | 1520lm | EEK=E
14kWh/1000h



Prod. no.: **1005307**



Product Prod. no.

- Concrete anchor
- Stainless steel **1000343**
- Ground spike
- grey **231234**
- Connection box IP68, 3-pole
- black **228730**

231455 675





SLOTS 45 Pole

SLOTS 65 Pole

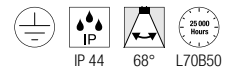
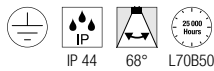
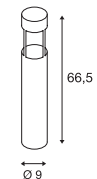
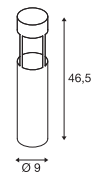

220-240V ~50/60Hz
 Total wattage: 4.5W
 Material: aluminium

220-240V ~50/60Hz
 Total wattage: 4.5W
 Material: aluminium

- Concrete anchor included

- Concrete anchor included



Down 200lm | 3000K



Down 200lm | 3000K

Options	Prod. no.
● anthracite	231815
● rust	231817

Options	Prod. no.
● anthracite	231455
● rust	231457

H-POL 30
Pole

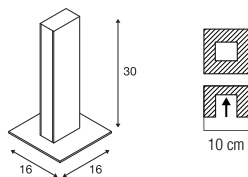

100-277V ~50/60Hz | 480mA
Total wattage: 9.7W
Material: aluminium/plastic

- This product is intended for in-floor installation
- A larger recessed fixing kit is available for optional installation in the ground. Installation dimensions
L: 14cm W: 14cm D: 16cm



Down 350lm | 3000K

Options	Prod. no.
● anthracite	232155



Product	Prod. no.
Recessed fixing kit 14x14 cm	
● black	232195

H-POL 60
Pole

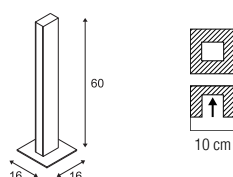

100-277V ~50/60Hz | 500mA
Total wattage: 18W
Material: aluminium/plastic

- This product is intended for in-floor installation.
- A larger recessed fixing kit is available for optional installation in the ground. Installation dimensions
L: 14cm W: 14cm D: 16cm



Down 700lm | 3000K

Options	Prod. no.
● anthracite	232165



Product	Prod. no.
Recessed fixing kit 14x14 cm	
● black	232195



232155

676

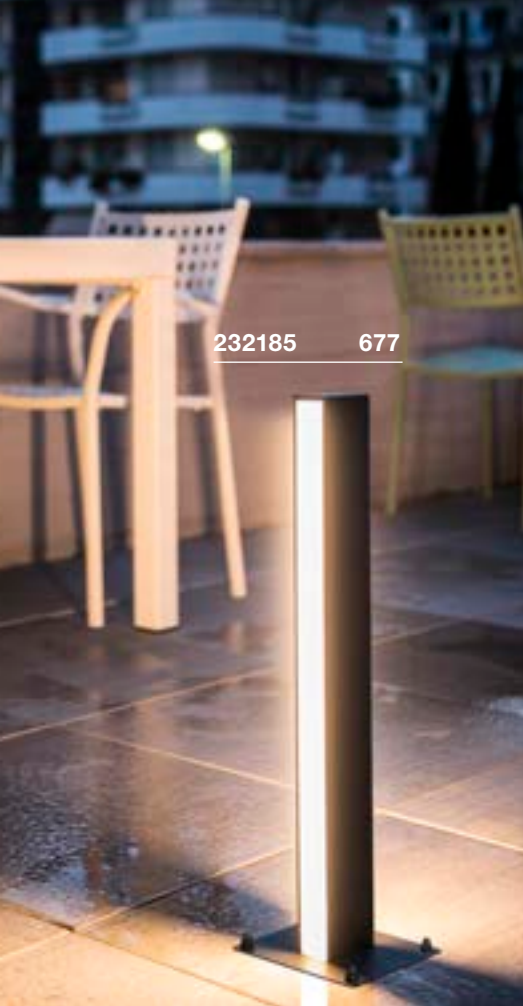

232185 677

H-POL TWIN 30 Pole

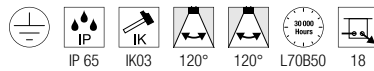
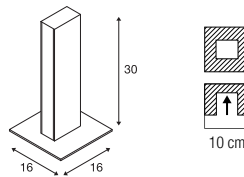

100-277V ~50/60Hz | 500mA
 Total wattage: 18W
 Material: aluminium/plastic

- This product is intended for in-floor installation.
- A larger recessed fixing kit is available for optional installation in the ground.
 Installation dimensions
 L: 14cm W: 14cm D: 16cm



Down 350lm | 3000K

Options	Prod. no.
● anthracite	232175



Product	Prod. no.
Recessed fixing kit 14x14 cm	
● black	232195

H-POL TWIN 60 Pole

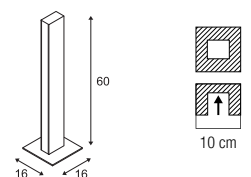

220-240V ~50/60Hz | 1000mA
 Total wattage: 35W
 Material: aluminium/plastic

- This product is intended for in-floor installation.
- A larger recessed fixing kit is available for optional installation in the ground.
 Installation dimensions
 L: 14cm W: 14cm D: 16cm



Down 700lm | 3000K

Options	Prod. no.
● anthracite	232185



Product	Prod. no.
Recessed fixing kit 14x14 cm	
● black	232195



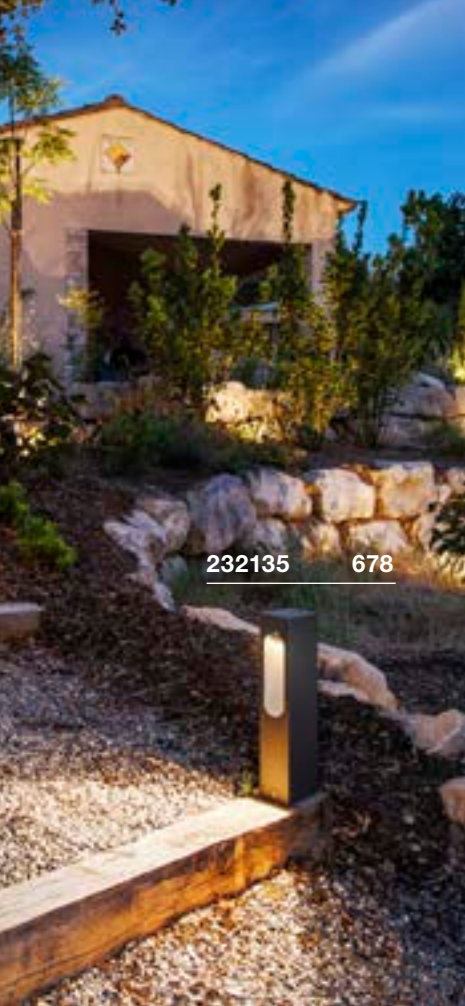

232135 678



232145 678

SLOTBOX 40 Pole

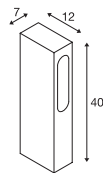

100-277 V ~50/60 Hz | 700 mA
Total wattage: 8W
Material: aluminium

- Open cable end



Down 160lm | 3000K

Options	Prod. no.
● anthracite	232135



Product	Prod. no.
Connection box IP68, 3-pole ● black	228730

SLOTBOX 70 Pole

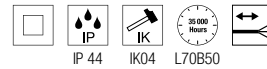
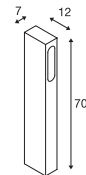

100-277 V ~50/60 Hz | 700 mA
Total wattage: 8.7W
Material: aluminium

- Open cable end



Down 160lm | 3000K

Options	Prod. no.
● anthracite	232145



Product	Prod. no.
Connection box IP68, 3-pole ● black	228730

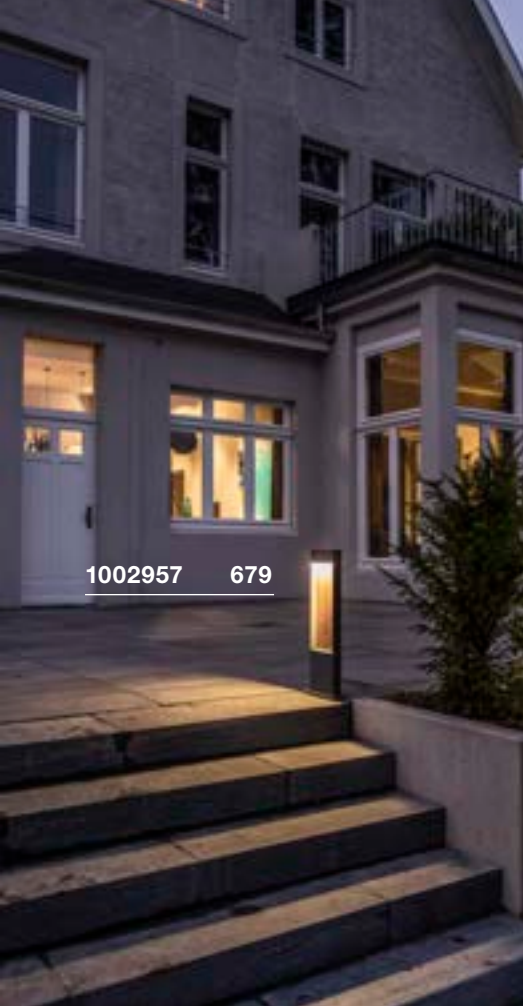

1002957 679



1002958 679

FLATT 65 POLE

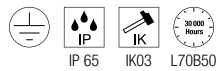
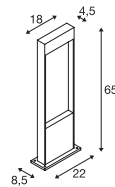
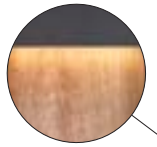

100-240V ~50/60Hz | 350mA
Total wattage: 10W
Material: aluminium/aluminium

- Light colour can be selected using the switch inside the housing prior to installation



Down 400lm | 3000K | 400lm | 4000K

Options	Prod. no.
● anthracite	1002956
● brown/anthracite	1002957



Product	Prod. no.
Connection box IP68, 3-pole	
● black	228730

FLATT 100 POLE

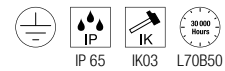
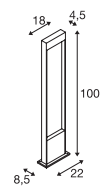

100-240V ~50/60Hz | 350mA
Total wattage: 10W
Material: aluminium/aluminium

- Light colour can be selected using the switch inside the housing prior to installation



Down 400lm | 3000K | 400lm | 4000K

Options	Prod. no.
● anthracite	1002958
● brown/anthracite	1002959



Product	Prod. no.
Connection box IP68, 3-pole	
● black	228730

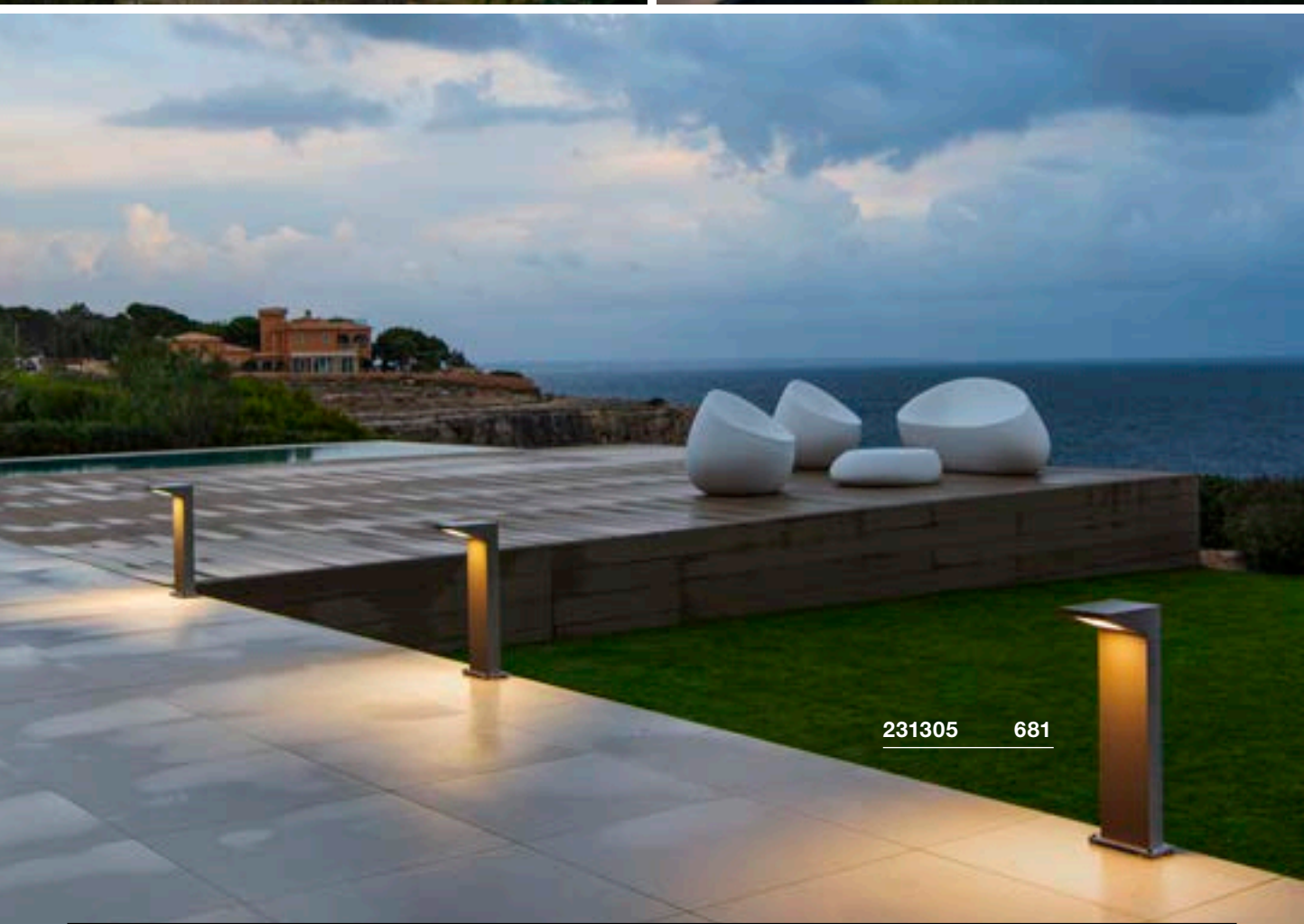



ABRIDOR 60 Pole

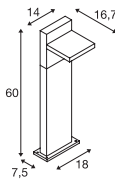

100-240V ~50/60Hz | 300mA
 Total wattage: 12W
 Material: aluminium



Down 950lm | 3000K | 980lm | 4000K

Options	Prod. no.
● anthracite	1002991

ABRIDOR 100 Pole

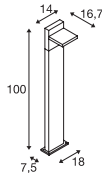

100-240V ~50/60Hz | 300mA
 Total wattage: 12W
 Material: aluminium



Down 950lm | 3000K | 980lm | 4000K

Options	Prod. no.
● anthracite	1002992

IPERI 50 Pole

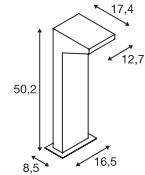

220-240V ~50/60Hz
 Total wattage: 4.5W
 Material: aluminium/plastic



Down 400lm | 4000K

Options	Prod. no.
● anthracite	231305



Product	Prod. no.
Ground spike	
● grey	231231

QUADRASYL 75
Pole, TCR-TSE

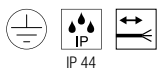
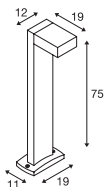

220-240V ~50/60Hz
Material: aluminium

- Concrete anchor included
- Open cable end



Base: 1xG53 Max. diameter: 7.5 cm L: 2.7 cm

Options	Prod. no.
● anthracite	232295
● grey	232294



LED GX53 | 6.1W | 120°
3000K | 490lm | EEK=G
6kWh/1000h



Prod. no.: 1005271



Product	Prod. no.
T-connector box	
● black	228726

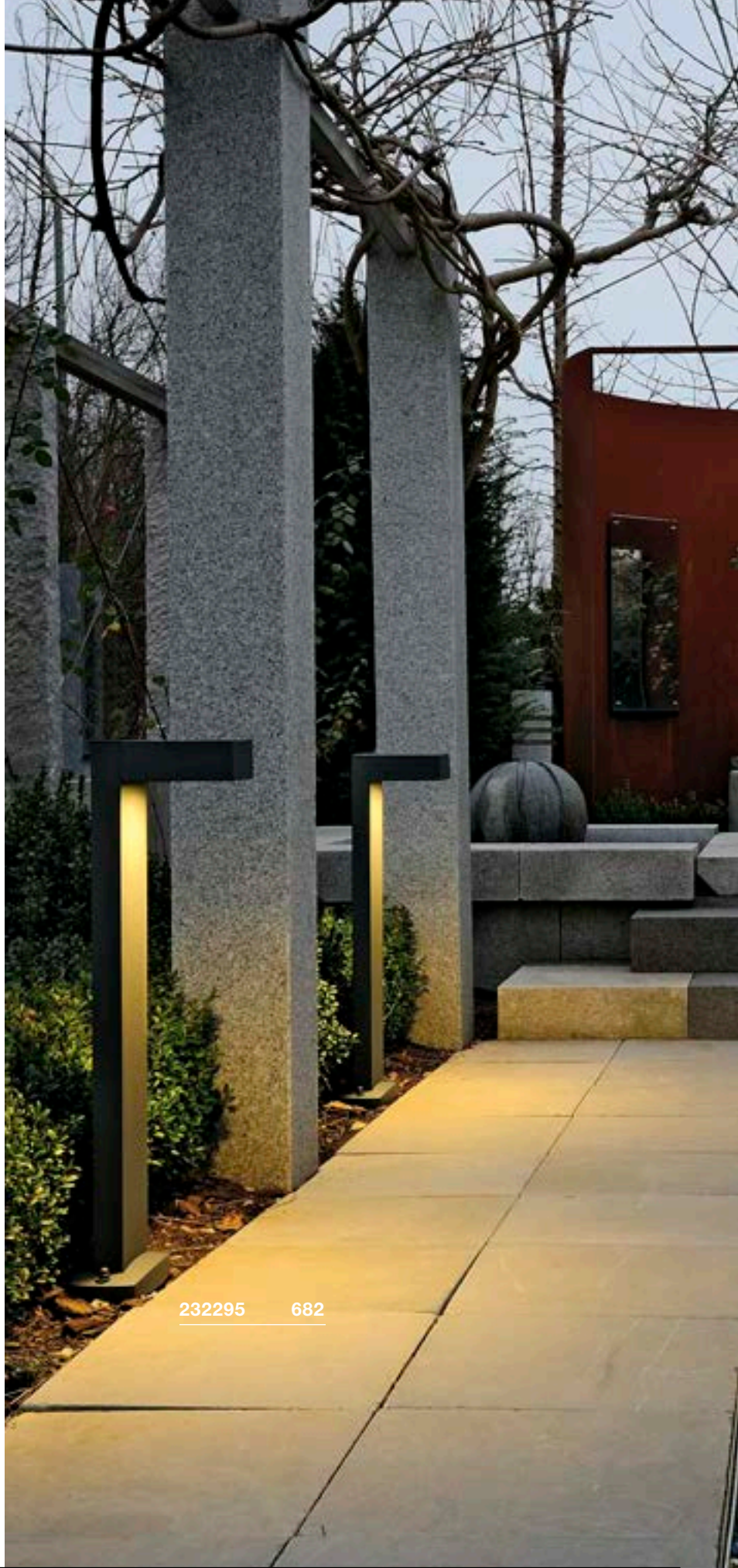

232295 682



1003001 683

QUAD POLE Pole

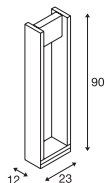

-
- IP 65
- IK02
- 100°
- L70B50
- 25 000 Hours
- 180°
-

100-277V ~50/60Hz | 500mA
 Total wattage: 18W
 Material: aluminium/glass

- Open cable end



Down 1550lm | 3000K

Options	Prod. no.
● anthracite	1003001

BOOKAT Pole

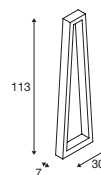

-
- IP 65
- IK05
- L70B50
- 30 000 Hours
- 10°
-

100-277 V ~50/60 Hz | 700 mA
 Total wattage: 15W
 Material: aluminium/polycarbonate (PC)

- IP connection box included
- IP connection box



Down 1240lm | 3000K | 1300lm | 4000K

Options	Prod. no.
● anthracite	1005441

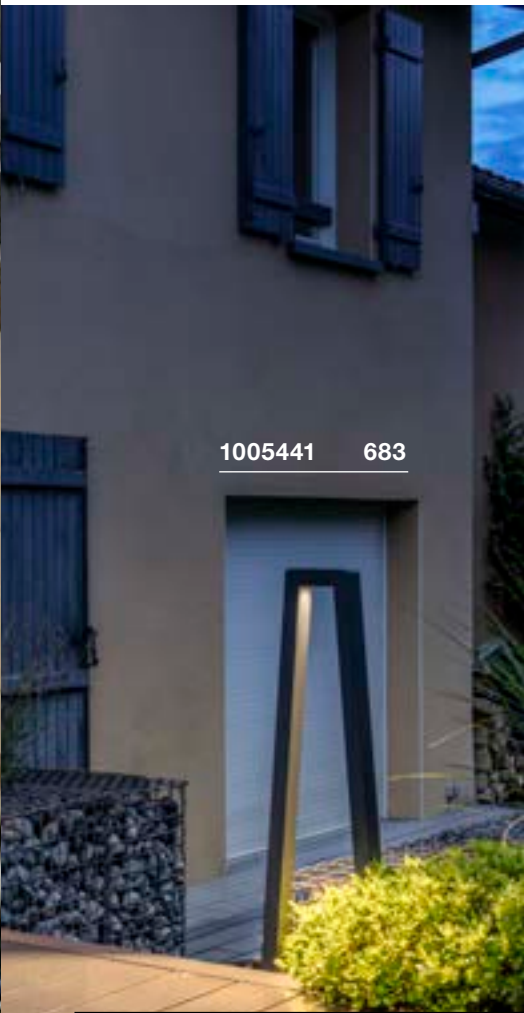

1005441 683



Product	Prod. no.
Connection box IP68, 3-pole	
● black	228730

RASCALI 45
Pole

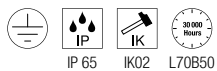
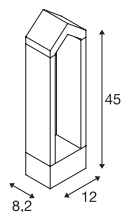

220-240V ~50/60Hz
Total wattage: 8W
Material: aluminium



Down 360lm | 3000K

Options	Prod. no.
● anthracite	1000799

RASCALI 65
Pole

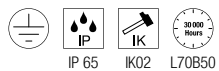
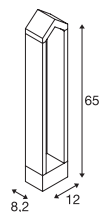

220-240V ~50/60Hz
Total wattage: 8W
Material: aluminium



Down 360lm | 3000K

Options	Prod. no.
● anthracite	1000801

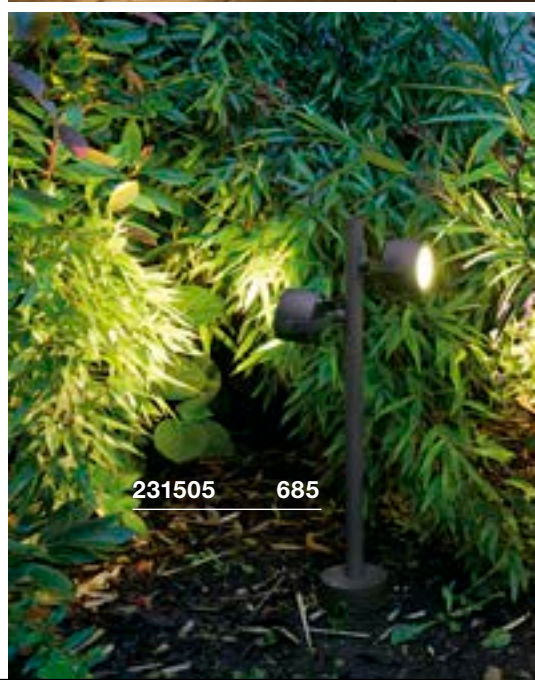
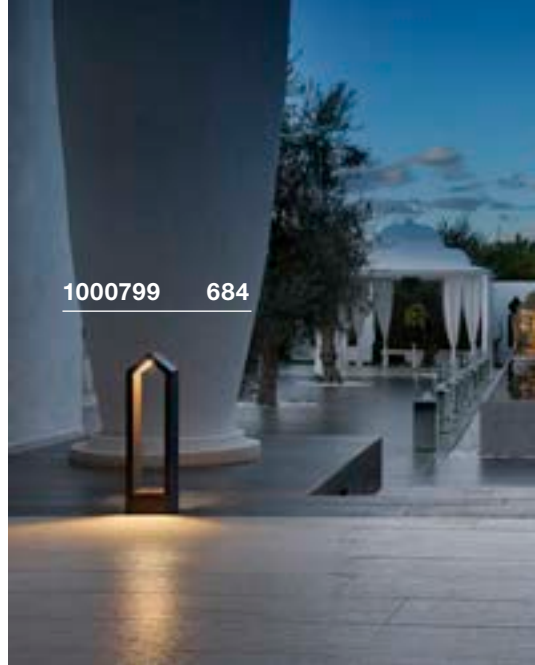



MYRA SPOT
Double, GU10

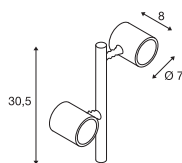

220-240V ~50/60Hz
Material: aluminium

- The height of the light can be increased by a maximum of 2 extension rods.
- Open cable end

SOCKET INSIDE <4.5 W

Base: 2xGU10 Max. diameter: 5.1 cm L: 5.7 cm

Options Prod. no.

- anthracite **233185**



LED GU10 51mm | 6W | 38°
2700K | 450lm | EEK=F
6kWh/1000h

Prod. no.: 1005075



Product Prod. no.

Concrete anchor

- silver **228712**

Screw set

- Stainless steel **228752**

Pedestal

- anthracite **233145**

Extension rod 30cm

- anthracite **233165**

SITRA 360
Pole, TCR-TSE

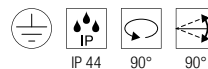
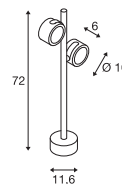

220-240V ~50/60Hz
Material: aluminium/glass

SOCKET INSIDE <9 W

Base: 2xG53 Max. diameter: 7.5 cm L: 3.5 cm

Options Prod. no.

- anthracite **231505**



LED GX53 | 6.1W | 120°
3000K | 490lm | EEK=G
6kWh/1000h

Prod. no.: 1005271



Product Prod. no.

Ground spike

- grey **230060**





1001962 697



LED
SYNA PLANT | 689



LED
SYNA GARDEN | 689



LED
SYNA | 689



LED
FLOODI S | 691



LED
FLOODI M | 691



LED
FLOODI L | 691



LED
GALEN 60 | 692



LED
GALEN 120 | 692



LED
FLAC BEAM® | 693



SOCKET
SAMRINA | 693



SOCKET
NAUTILUS 10 | 694



SOCKET
BIG NAUTILUS | 694



SOCKET
NAUTILUS 10 | 695



LED
NAUTILUS 10 | 696



SOCKET
NAUTILUS | 697



SOCKET
NAUTILUS 10
SPOT | 697



LED
NAUTILUS 10
SPOT LED | 697



LED
DASAR®
PROJECTOR | 698



LED
DASAR® 920 | 698



LED
HELIA SPOT S | 699



LED
HELIA SPOT L | 699



SOCKET
THEO BRACKET | 701



LED
LED SPIKE | 701



SOCKET
SITRA 360 SPIKE | 703



SOCKET
SITRA 360 SPIKE | 703

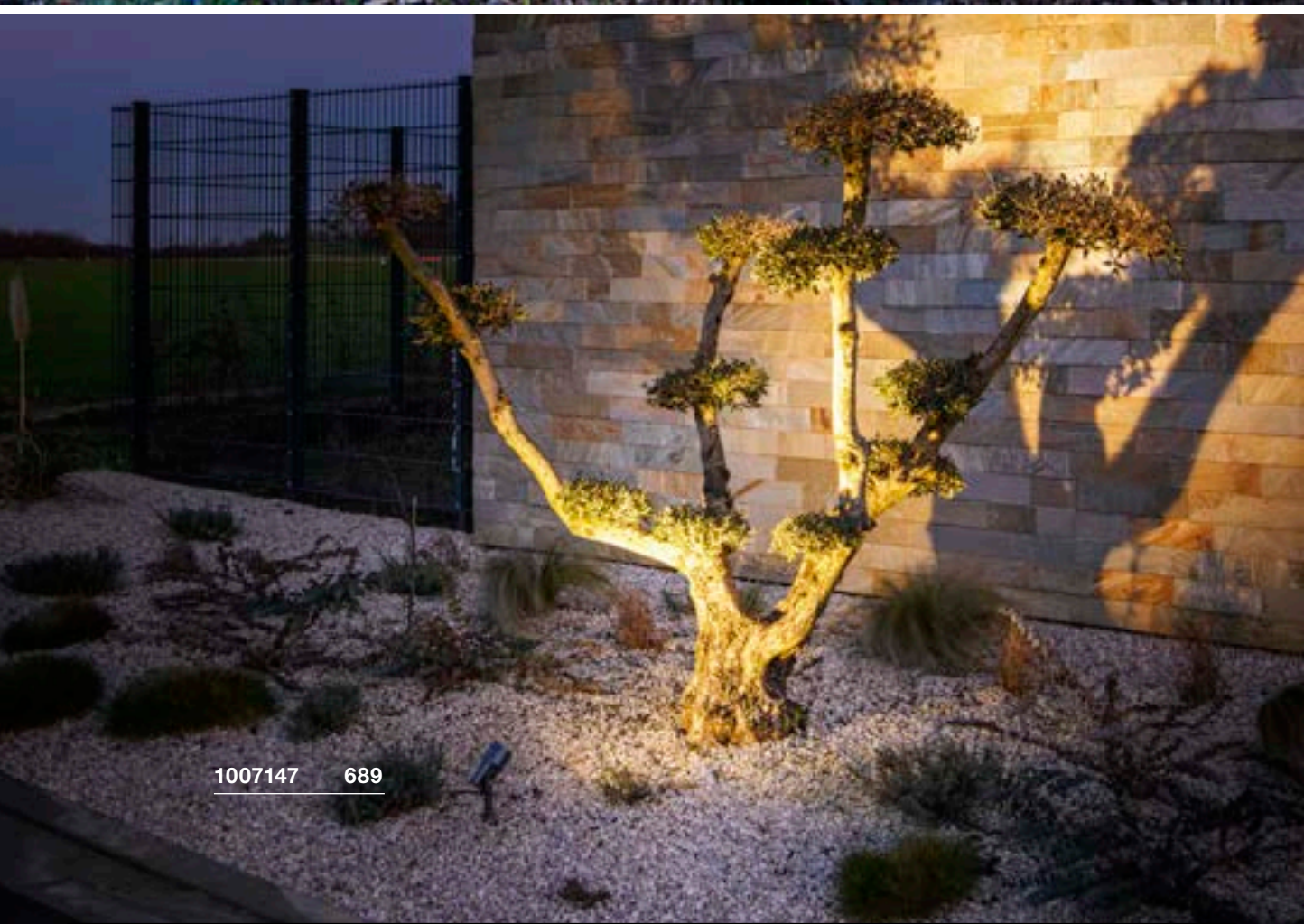



SYNA PLANT SP

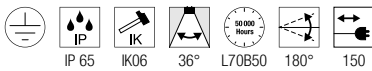
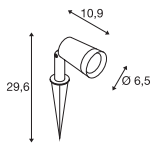

220-240V ~50/60Hz | 250mA
Total wattage: 6W
Material: aluminium

- IP44 safety plug



Down 540lm | 3000K

Options	Prod. no.
● black	1007146 ●

SYNA GARDEN SP

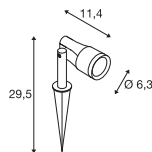

220-240V ~50/60Hz | 250mA
Total wattage: 6W
Material: aluminium

- IP44 safety plug



Down 540lm | 3000K

Options	Prod. no.
● black	1007147 ●

SYNA SP

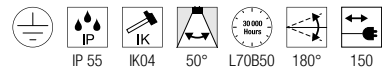
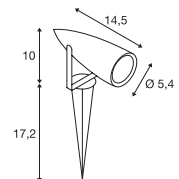

220-240V ~50/60Hz
Total wattage: 9W
Material: aluminium/acrylic

- IP44 safety plug



Down 470lm | 3000K

Options	Prod. no.
● anthracite	227505



1006193 691



FLOODI S
SP

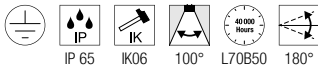
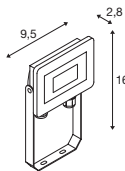

220-240V ~50/60Hz
Total wattage: 9.3W
Material: aluminium



Down 1040lm | 3000K

Options	Prod. no.
● anthracite	1006191

Product	Prod. no.
Sensor ● black	1006326

FLOODI M
SP

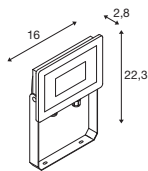

220-240V ~50/60Hz
Total wattage: 30W
Material: aluminium



Down 2980lm | 3000K

Options	Prod. no.
● anthracite	1006192

Product	Prod. no.
Sensor ● black	1006326

FLOODI L
SP

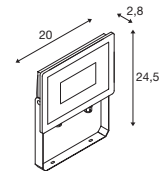

220-240V ~50/60Hz
Total wattage: 48W
Material: aluminium



Down 5150lm | 3000K

Options	Prod. no.
● anthracite	1006193

Product	Prod. no.
Sensor ● black	1006326

GALEN 60 SP

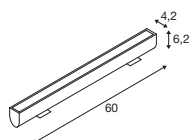

220-240V ~50/60Hz | 450mA
Total wattage: 18W
Material: aluminium/glass



Down 1570lm | 3000K | 1570lm | 4000K

Options	Prod. no.
● anthracite	1003447



Product	Prod. no.
5m connection cable with open cable end	
● black	231960
Connection cable 1.0m	
● black	231961

GALEN 120 SP

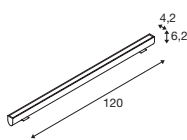

220-240V ~50/60Hz | 900mA
Total wattage: 34W
Material: aluminium/glass



Down 3000lm | 3000K | 3100lm | 4000K

Options	Prod. no.
● anthracite	1003448



Product	Prod. no.
5m connection cable with open cable end	
● black	231960
Connection cable 1.0m	
● black	231961





FLAC BEAM®
SP

SAMRINA
SP, single, GU10

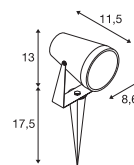
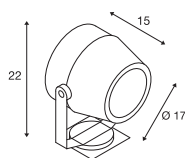

220-240V ~50/60Hz
Total wattage: 27W
Material: aluminium/glass

220-240V ~50/60Hz
Material: plastic/glass

- IP44 safety plug

- Contains recycled material
- IP44 safety plug



Down 1600lm | 3000K

Base: GU10 Max. diameter: 6 cm | L: 6 cm

Options	Prod. no.
● grey	231072

Options	Prod. no.
● black	1004757



LED GU10 51mm | 6W | 38°
2700K | 450lm | EEK=F
6kWh/1000h



Prod. no.: 1005077



NAUTILUS 10
SP, Round, QPAR51

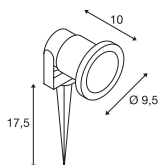

220-240V ~50/60Hz
Material: aluminium

- IP44 safety plug



Base: 1xGU10 max. L: 5.7 cm

Options	Prod. no.
● grey	227418

LED GU10 51mm | 6W | 38°
 2700K | 450lm | EEK=F
 6kWh/1000h

Prod. no.: 1005077

BIG NAUTILUS
SP, Round, QPAR51

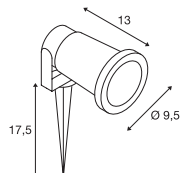

220-240V ~50/60Hz
Material: aluminium

- IP44 safety plug



Base: GU10 Max. diameter: 5.1 cm | L: 8.3 cm

Options	Prod. no.
● black	227410
● rust	1001964
● green	1001965

LED GU10 51mm | 6W | 38°
 2700K | 450lm | EEK=F
 6kWh/1000h

Prod. no.: 1005077

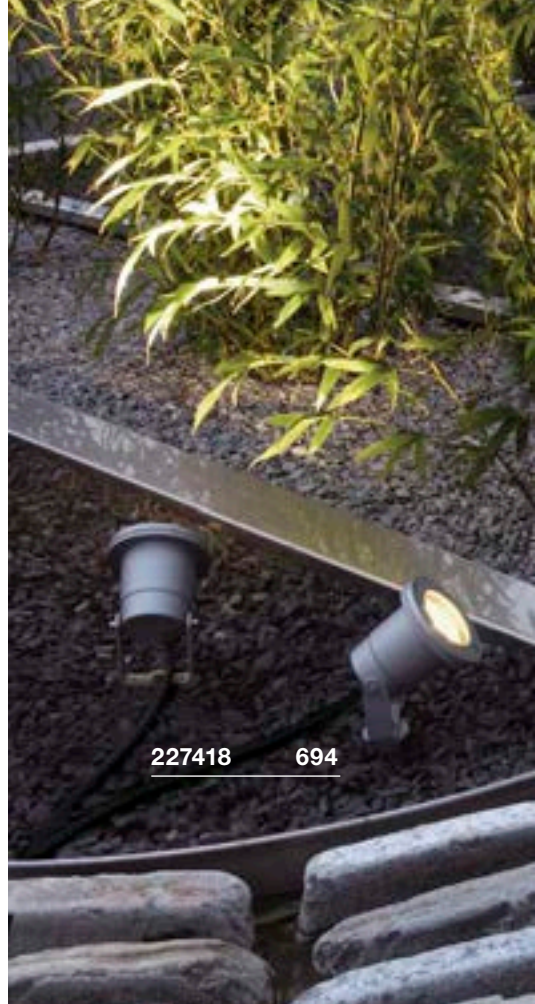

227418 694

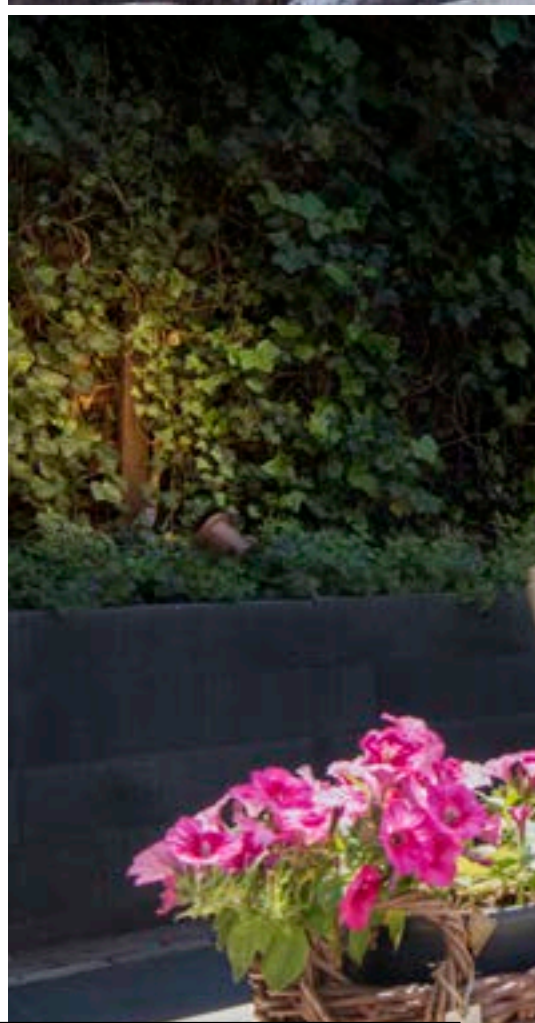



NAUTILUS 10
SP, Round, QPAR51

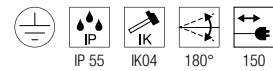
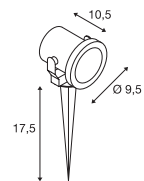

220-240V ~50/60Hz
Material: stainless steel 316

- IP44 safety plug

SOCKET INSIDE <25 W

Base: 1xGU10 Max. diameter: 5.1 cm L: 5.7 cm

Options	Prod. no.
● Stainless steel	229740



LED GU10 51mm | 6W | 38°
2700K | 450lm | EEK=F
6kWh/1000h



Prod. no.: 1005077

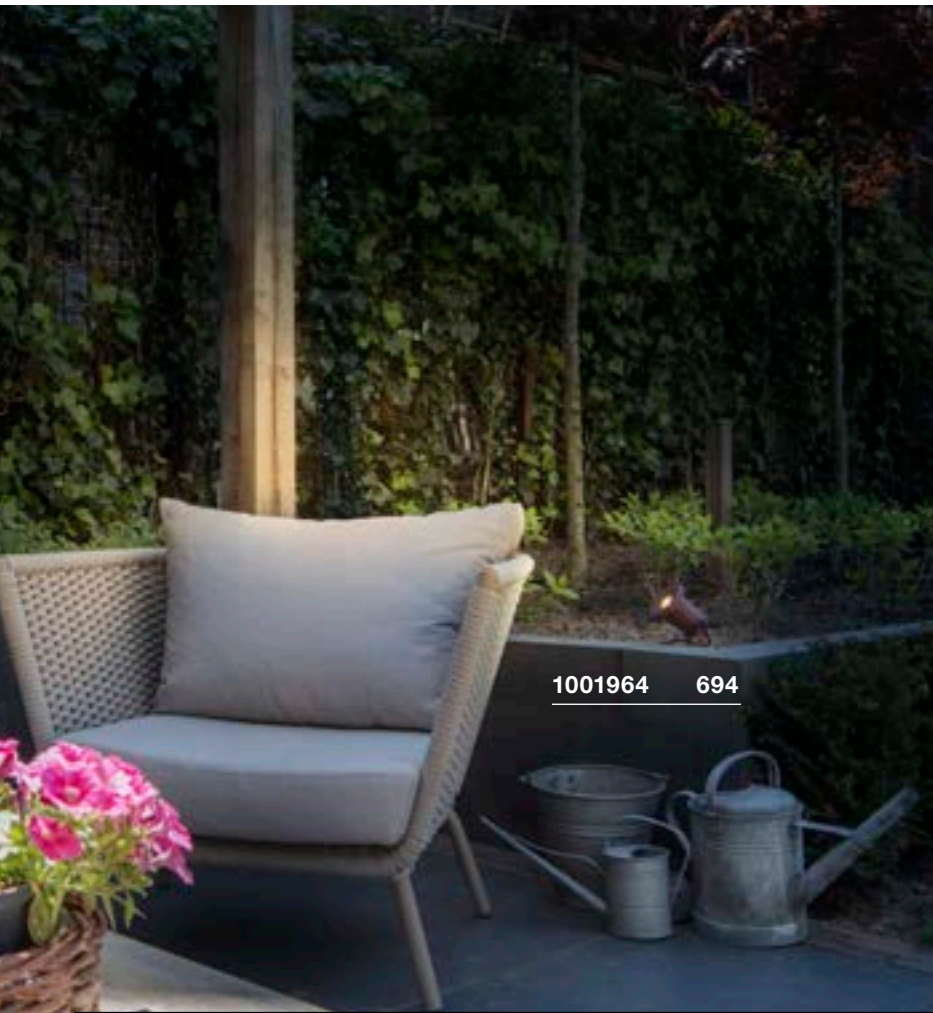

1001964 694



231035 696

NAUTILUS 10 SP, square

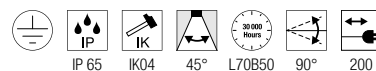
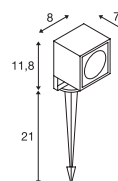

100-277 V ~50/60 Hz | 700 mA
Total wattage: 8.5W
Material: aluminium/glass

- IP44 safety plug



1001962 697



CRI
80

Down

660lm | 3000K

Options	Prod. no.
● anthracite	231035



NAUTILUS SP, QR-C51

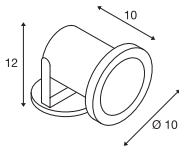

12V ~50Hz
Material: stainless steel 304/glass

- Open cable end



Base: 1xGX5.3

Options	Prod. no.
● Stainless steel	229090



LED GU5.3 | 5.8W | 36°
2700K | 450lm | EEK=G
6kWh/1000h

Prod. no.: **1001574**



NAUTILUS 10 SPOT SP, QPAR51

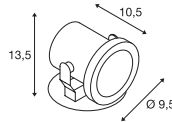

220-240V ~50/60Hz
Material: stainless steel 316

- Open cable end



Base: 1xGU10 Max. diameter: 5.1 cm | L: 6 cm

Options	Prod. no.
● Stainless steel	229741



LED GU10 51mm | 6W | 38°
2700K | 450lm | EEK=F
6kWh/1000h

Prod. no.: **1005077**



Product	Prod. no.
Connection box IP68, 3-pole	
● black	228730

NAUTILUS 10 SPOT LED SP

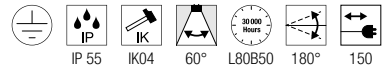
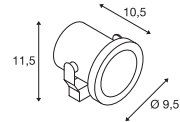

220-240V ~50/60Hz
Total wattage: 9W
Material: stainless steel 316

- IP44 safety plug



Down 520lm | 3000K

Options	Prod. no.
● Stainless steel	1001962



Product	Prod. no.
Plastic ground spike	
● black	900011
Mounting plate	
● Stainless steel	1001963

DASAR® PROJECTOR
SP, 12/24V

DASAR® 920
SP, 230V

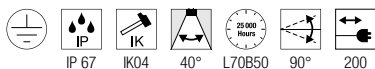
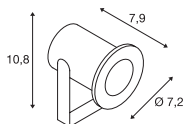
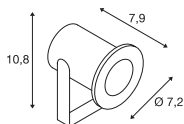

12-24V DC
Total wattage: 6.5W
Material: stainless steel 316/glass

220-240V ~50/60Hz | 400mA
Total wattage: 4.6W
Material: stainless steel 316/glass

- Open cable end

- IP44 safety plug



Down 520lm | 3000K

Down 300lm | 3000K

Options	Prod. no.
● Stainless steel	233570

Options	Prod. no.
● Stainless steel	233571



Product	Prod. no.
Stainless steel 316 ground spike	
● Stainless steel	233580
Plastic ground spike	
● black	900011
LED power supply 15W 12V	
○ white	1005444
LED power supply 15 W 24V	
○ white	1005445
Stainless steel 316 mounting plate	
● Stainless steel	233582

Product	Prod. no.
Stainless steel 316 ground spike	
● Stainless steel	233580
Plastic ground spike	
● black	900011
Stainless steel 316 mounting plate	
● Stainless steel	233582

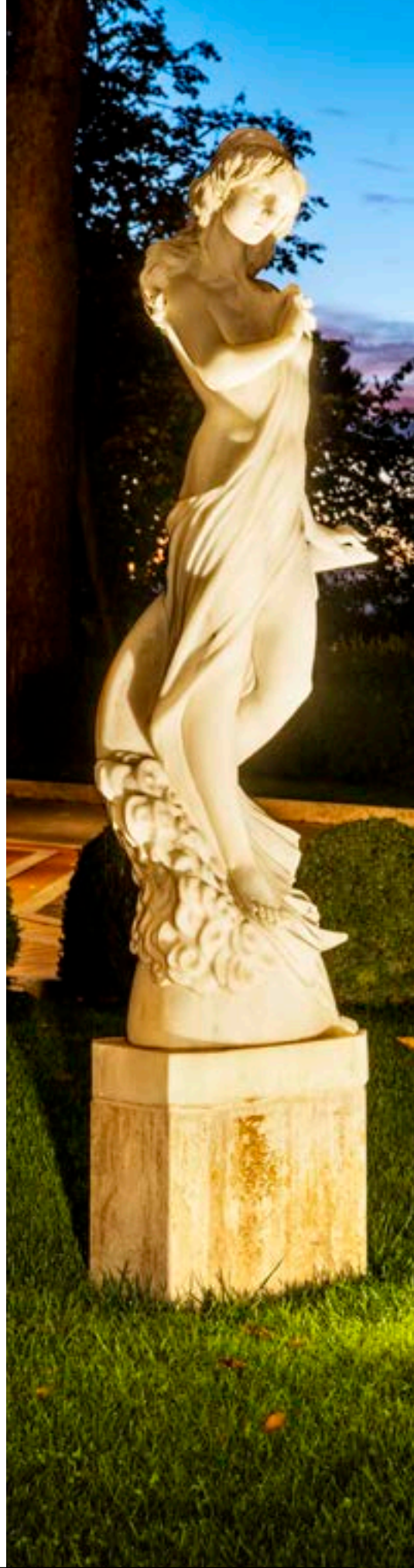



HELIA SPOT S SP, single

HELIA SPOT L SP, single, PHASE

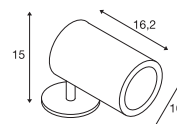
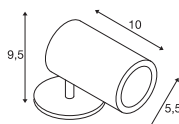

220-240V ~50/60Hz | 500mA
Total wattage: 6.5W
Material: aluminium

- IP44 safety plug



Down 440lm | 3000K

Options	Prod. no.
● anthracite	1000735



Product	Prod. no.
Ground spike	
● Stainless steel	1000736

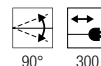

220-240V ~50/60Hz | 700mA
Total wattage: 15W
Material: aluminium/glass

- IP44 safety plug



Down 1340lm | 3000K

Options	Prod. no.
● anthracite	228555



Product	Prod. no.
Ground spike	
● Stainless steel	228560

233570 698



1004652 701

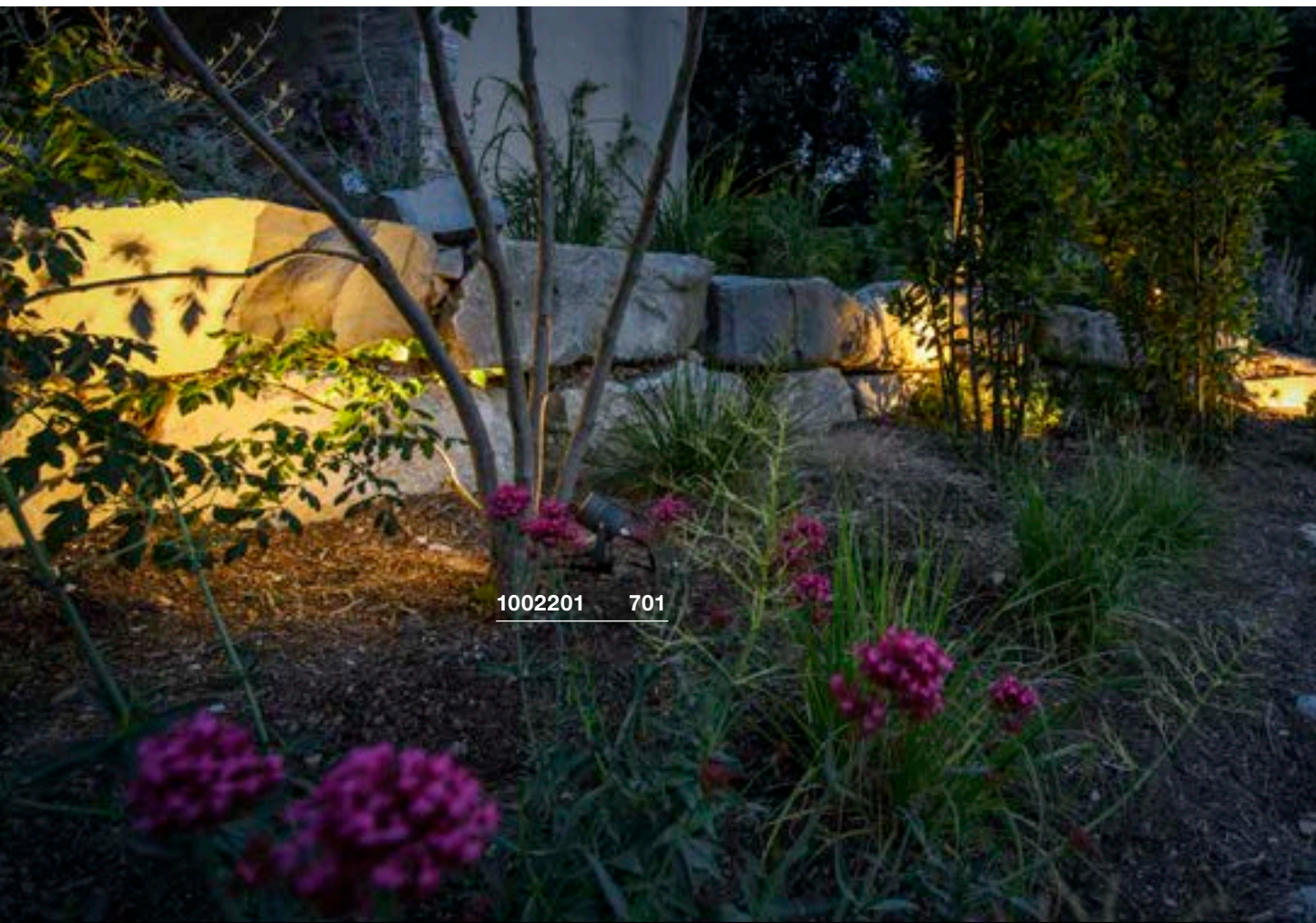

1002201 701



THEO BRACKET SP

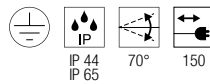
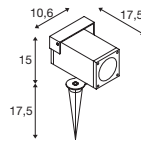

220-240V ~50/60Hz
Material: aluminium/glass

- IP44 safety plug



Base: 1xGU10 Max. diameter: 5.1 cm | L: 5.7 cm

Options	Prod. no.
● anthracite	1004652



LED GU10 51mm | 6W | 38°
2700K | 450lm | EEK=F
6kWh/1000h

Prod. no.: 1005077



LED SPIKE SP

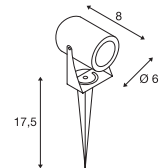

100-240V ~50/60Hz | 240mA
Total wattage: 6W
Material: aluminium/glass

- IP44 safety plug



Down 400lm | 3000K

Options	Prod. no.
● anthracite	1002201
● rust	1002203



231535 703



SITRA 360 SPIKE
SP, single, TCR-TSE

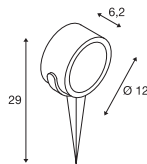

220-240V ~50/60Hz
Material: aluminium/glass

- IP44 safety plug

SOCKET INSIDE <9 W

Base: 1xG53 Max. diameter: 7.5 cm L: 3.5 cm

Options	Prod. no.
● anthracite	231525



LED GX53 | 6.1W | 120°
3000K | 490lm | EEK=G
6kWh/1000h



Prod. no.: 1005271

SITRA 360 SPIKE
SP, double, TCR-TSE

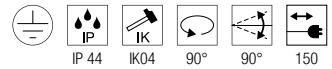
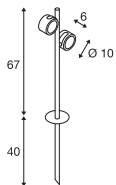

220-240V ~50/60Hz
Material: aluminium/glass

- IP44 safety plug

SOCKET INSIDE <9 W

Base: 2xG53 Max. diameter: 7.5 cm L: 3.5 cm

Options	Prod. no.
● anthracite	231535



LED GX53 | 6.1W | 120°
3000K | 490lm | EEK=G
6kWh/1000h



Prod. no.: 1005271



234515

735



NEW

SCKET
PHOTONI | 709



NEW

LED
LID II | 711



NEW

LED
LID II | 711



NEW

LED
LID I | 713



NEW

LED
LID I | 713



NEW

LED
I-RING | 714



NEW

LED
OVAL 14 | 715



NEW

LED
OVAL 18 | 715



NEW

LED
CONCRETO M | 717



NEW

LED
CONCRETO L | 717



LED
VANO WING | 719



LED
VANO WING | 719



LED
MANA BASE | 720



NEW

LED
RUSTY® MANA | 720



NEW

LED
RUSTY® MANA | 720



LED
MANA OUT | 721



NEW

LED
MANA OUT | 721



NEW

LED
ENOLA OCULUS | 723



NEW

LED
ENOLA OCULUS | 723



LED
ENOLA OCULUS S | 725



LED
ENOLA OCULUS M | 725



LED
ENOLA ROUND L | 725



LED
ENOLA ROUND S UP/DOWN | 727



LED
ENOLA ROUND M UP/DOWN | 727



LED
ENOLA ROUND L UP/DOWN | 727



LED
ENOLA SQUARE S | 729



LED
ENOLA SQUARE M | 729



LED
ENOLA SQUARE L | 729



LED
ENOLA SQUARE S UP/DOWN | 730



LED
ENOLA SQUARE M UP/DOWN | 730



LED
ENOLA SQUARE L UP/DOWN | 730



SCKET
THEO UP/DOWN | 735



LED
BIG THEO BEAM UP/ FLOOD DOWN | 735



SCKET
BIG THEO UP/DOWN | 735



LED
BIG THEO FLOOD UP/DOWN | 736



SCKET
THEO | 736



SCKET
BIG THEO | 737



LED
BIG THEO | 737



LED
SITRA S | 739



LED
SITRA S | 739



LED
SITRA M | 741



LED
SITRA L | 741

NEW



SCKET
SITRA CUBE | 741



SCKET
GRAFIT | 742



SCKET
GRAFIT | 742



SCKET
GRAFIT | 743



SCKET
GRAFIT | 743



LED
QUADRULO | 744



SCKET
QUADRULO
SENSOR | 745



SCKET
QUADRULO | 745



SCKET
MERIDIAN | 746



SCKET
MERIDIAN BOX | 746



SCKET
MERIDIAN BOX
SENSOR | 747



SCKET
MERIDIAN BOX | 747



LED
ESKINA FRAME | 749



LED
ESKINA FRAME | 749



LED
ESKINA FRAME | 749



LED
BOOKAT | 751



LED
BIG QUAD | 752



LED
QUAD | 752



LED
QUAD
UP/DOWN 15 | 753



LED
BIG QUAD
UP/DOWN | 755



LED
BIG QUAD | 755



LED
RUSTY®
UP/DOWN | 756



LED
RUSTY®
UP/DOWN | 756



LED
OVALISK
SENSOR | 757



LED
OVALISK | 757



LED
PEMA® | 758



LED
PEMA® | 759



LED
PEMA® | 759



SCKET
PEMA® | 759



LED
FLATT SENSOR | 760



LED
FLATT | 760



SCKET
ASTINA | 761



SCKET
ASTINA STEEL | 761



LED
ANGOLUX
SENSOR | 762



LED
ANGOLUX | 762



LED
VILUA S | 763



LED
VILUA L | 763



LED
VILUA | 763



SCKET
MYRA
UP/DOWN | 764



LED
SITRA
UP/DOWN | 765



SCKET
SITRA
UP/DOWN | 765



SCKET
ROX | 767



SCKET
ROX UP/DOWN | 767



LED
DELWA | 767



LED
SLOTS | 768



SCKET
WALLYX | 768



LED
DOWNUNDER
OUT | 769



LED
DOWNUNDER
OUT | 769



LED
ABRIDOR
SENSOR | 770



LED
ABRIDOR | 770



LED
ORDI SENSOR | 771



LED
ORDI | 771



SCKET
BOX-L | 773



LED
BOX-L | 773



SCKET
BOX UP/DOWN | 773



LED
LOGS | 775



LED
OUT-BEAM UP /
FLOOD DOWN | 775



LED
L-LINE OUT | 775



SCKET
PHOTONIA | 777



SCKET
MOLAT | 777



SCKET
GLOO PURE | 777



SCKET
F-POL | 778



SCKET
SQUARE | 779



SCKET
KERAS ELT | 779



SCKET
SITRA | 779



LED
RASCALI | 780



LED
IPERI | 780



SCKET
QUADRASYL | 781



SCKET
SQUARE TURN | 781



LED
TODAY PRO | 783



LED
ESKINA D | 783



SCKET
MYRA DISPLAY | 783



LED
LED SPOT | 785



SCKET
NAUTILUS | 785



SCKET
MYRA | 785

1007585 709





PHOTONI
WL, E27

NEW

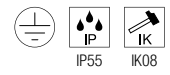
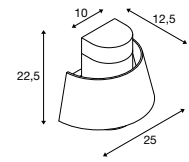

220-240V ~50/60Hz
Material: aluminium

- sea-air-resistant

SOCKET
INSIDE 13 W

Base: 1xE27 Max. diameter: 6 cm L: 11.6 cm

Options	Prod. no.
● black	1007585
● rust	1007581



LED E27 | 8W | 240°
3000K | 880lm | EEK=E
8kWh/1000h



Prod. no.: 1005289



1007281 711



LID II
WL

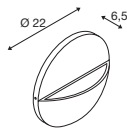

220-240V ~50/60Hz | 350mA
Total wattage: 15W
Material: aluminium



Down 800lm | 2700K | 800lm | 3000K

Options	Prod. no.
● anthracite	1007282 ●

LID II
WL, up/down

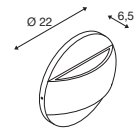

220-240V ~50/60Hz | 700mA
Total wattage: 28W
Material: aluminium



Up 750lm | 2700K | 750lm | 3000K
Down 750lm | 2700K | 750lm | 3000K

Options	Prod. no.
● anthracite	1007281 ●

1007667 713





LID I WL, single



NEW

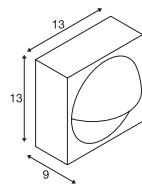

220-240V ~50/60Hz | 350mA
Total wattage: 15W
Material: aluminium



Down 900lm | 2700K | 1050lm | 3000K

Options	Prod. no.
● anthracite	1007667 ●

LID I WL, double



NEW

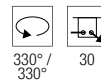
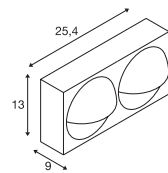
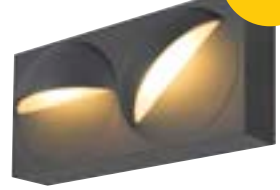

220-240V ~50/60Hz | 700mA
Total wattage: 29W
Material: aluminium



Spot 1 850lm | 2700K | 1000lm | 3000K
Spot 2 850lm | 2700K | 1000lm | 3000K

Options	Prod. no.
● anthracite	1007668 ●



1007236 714

I-RING WL

NEW

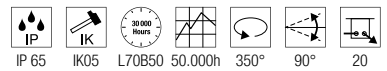
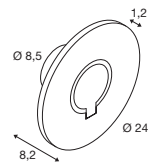

100-240V ~50/60Hz | 350mA
Total wattage: 9.2W
Material: aluminium



CRI
80

Down

670lm | 3000K

Options

● anthracite

Prod. no.

1007236 ●



OVAL 14
WL, up/down

OVAL 18
WL, up/down

1007142 715

NEW



NEW

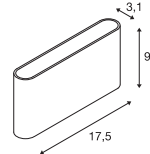
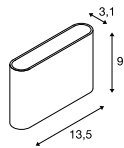

220-240V ~50/60Hz | 145mA
Total wattage: 5.7W
Material: aluminium/polycarbonate (PC)

220-240V ~50/60Hz | 275mA
Total wattage: 9.3W
Material: aluminium/polycarbonate (PC)



Up	280lm	2700K	280lm	3000K
Down	280lm	2700K	280lm	3000K

Up	430lm	2700K	430lm	3000K
Down	430lm	2700K	430lm	3000K

Options	Prod. no.
● black	1007142 ●
○ white	1007143 ●

Options	Prod. no.
● black	1007144 ●
○ white	1007145 ●

1006405 717





CONCRETO M WL

CONCRETO L WL

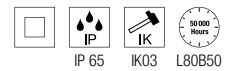
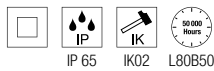
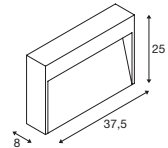
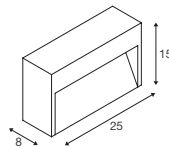

220-240V ~50/60Hz | 700mA
Total wattage: 8.5W
Material: concrete/aluminium

220-240V ~50/60Hz | 700mA
Total wattage: 12W
Material: concrete/aluminium



Down 270lm | 3000K

Down 470lm | 3000K

Options	Prod. no.
● grey	1006404 ●

Options	Prod. no.
● grey	1006405 ●

JAS DOMINICAS

ONASTERIO
A CATALINA DE SIENA



VANO WING SP, DALI

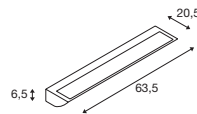

220-240V ~50/60Hz | 500mA
Total wattage: 25W
Material: aluminium/glass



Down 1400lm | 3000K

Options	Prod. no.
● grey	1006268

VANO WING SP, DALI

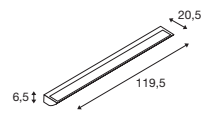

220-240V ~50/60Hz | 1050mA
Total wattage: 49W
Material: aluminium/glass



Down 3140lm | 3000K

Options	Prod. no.
● grey	1006270

MANA BASE
WL, round, PHASE

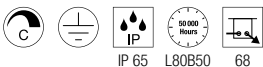
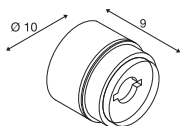

220-240V ~50/60Hz | 350mA
Total wattage: 15W
Material: aluminium/polycarbonate (PC)



Down 800lm | 2700K | 820lm | 3000K

Options	Prod. no.
● anthracite	1006319

RUSTY® MANA
shade, square



L: 28 cm W: 28 cm H: 1.5 cm
Material: FeCSi steel

Options	Prod. no.
● rust	1006317 ●

RUSTY® MANA
shade, round



H: 1.5 cm Diameter: 28 cm
Material: FeCSi steel

Options	Prod. no.
● rust	1006318 ●

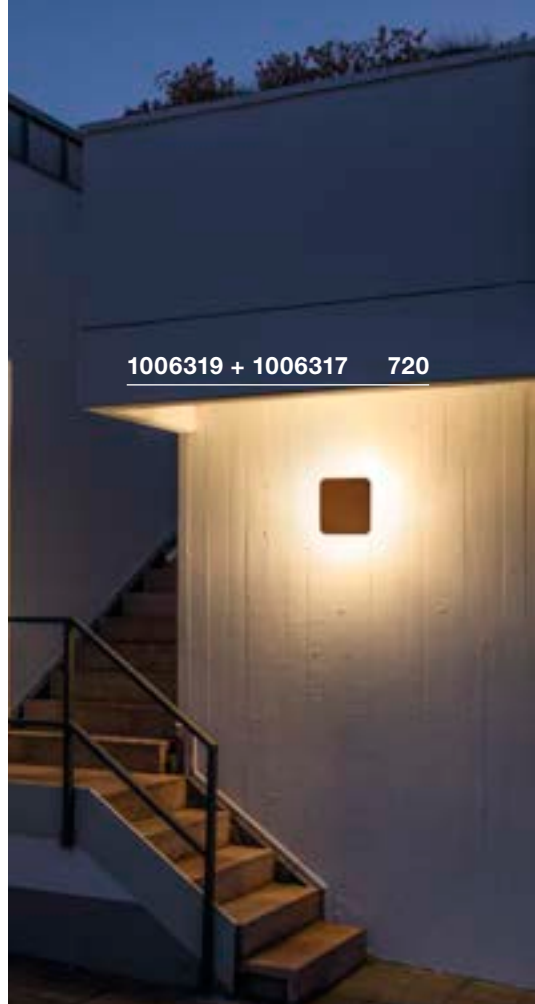



1002902 721



MANA OUT
WL, PHASE

MANA OUT
WL, Set

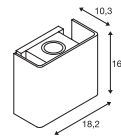
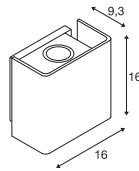

220-240V ~50/60Hz | 500mA
Total wattage: 11W
Material: aluminium/aluminium

220-240V ~50/60Hz | 500mA
Total wattage: 11W
Material: aluminium/concrete



Up 325lm | 3000K
Down 325lm | 3000K

Up 325lm | 3000K
Down 325lm | 3000K

Options	Prod. no.
● anthracite	1002900
● rust	1002902

Options	Prod. no.
● grey	1003470 ●

1006328 723

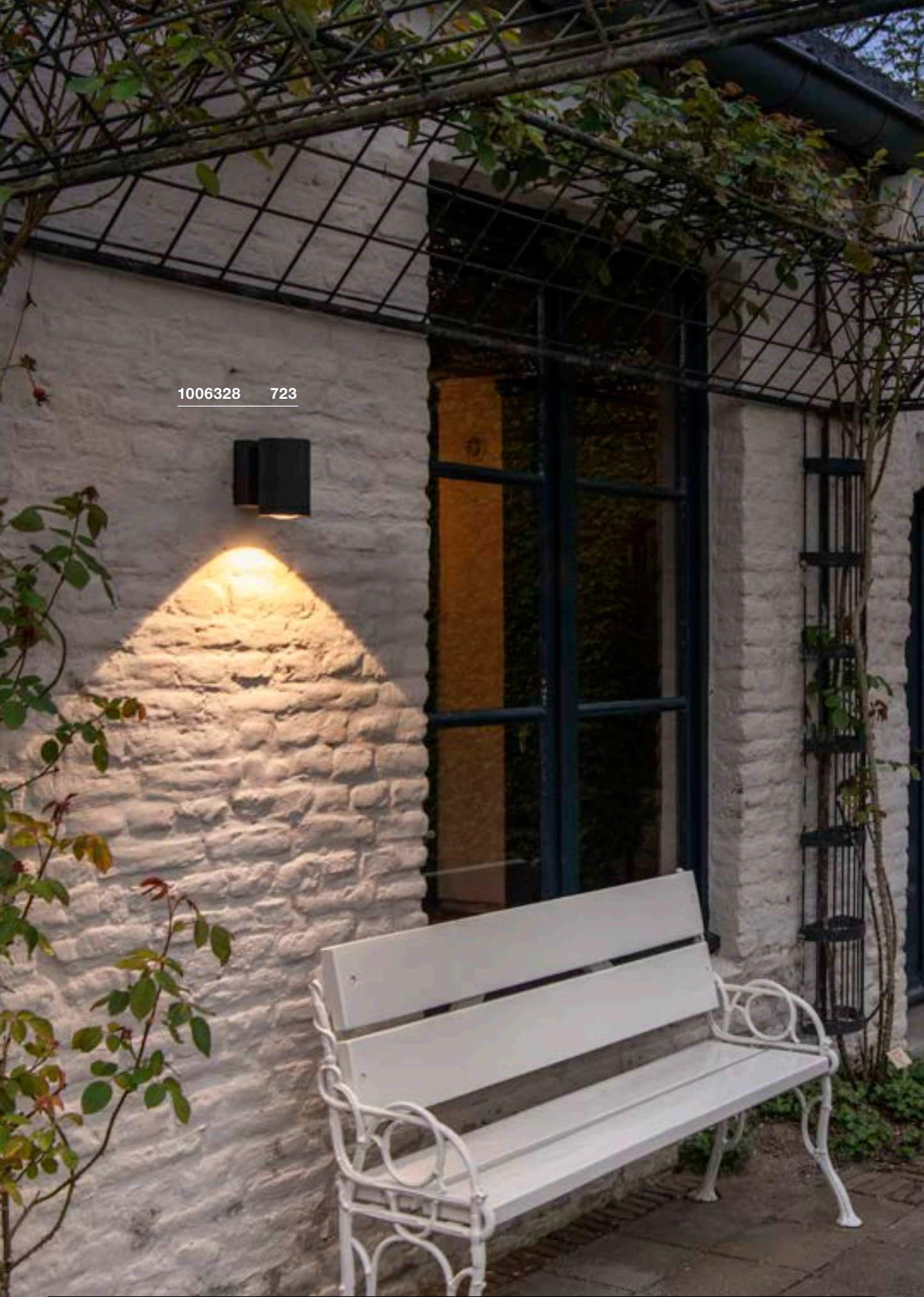



ENOLA OCULUS WL, single

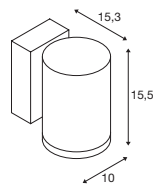

220-240V ~50/60Hz | 500mA
Total wattage: 11W
Material: aluminium/glass



Down	1000lm 3000K	1100lm 4000K
------	----------------	----------------

Options	Prod. no.
● anthracite	1006328 ●



Product	Prod. no.
Spacer	
● anthracite	1002853

ENOLA OCULUS WL, up/down

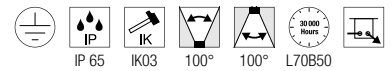
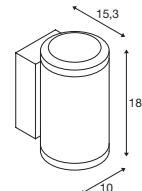

220-240V ~50/60Hz | 500mA
Total wattage: 20W
Material: aluminium/glass



Up	940lm 3000K	1060lm 4000K
Down	940lm 3000K	1060lm 4000K

Options	Prod. no.
● anthracite	1006329 ●



Product	Prod. no.
Spacer	
● anthracite	1002853

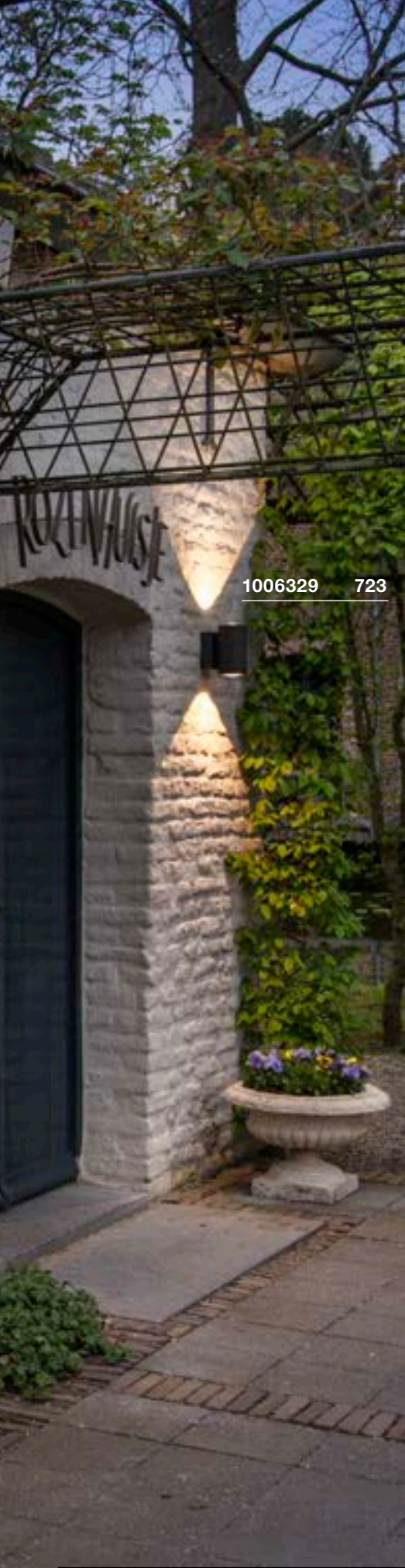

1006329 723

1003440 725





ENOLA ROUND S WL, single

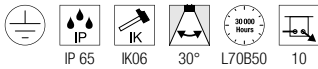
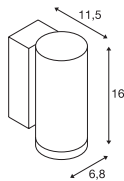

100-240V ~50/60Hz | 500mA
Total wattage: 6W
Material: aluminium/glass



Down 450lm | 3000K | 500lm | 4000K

Options	Prod. no.
● anthracite	1003422



Product	Prod. no.
Spacer	
● anthracite	1002853
Reflector 60°	
● chrome	1005262

ENOLA ROUND M WL, single

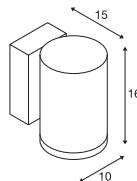

220-240V ~50/60Hz | 500mA
Total wattage: 11W
Material: aluminium/glass



Down 860lm | 3000K | 980lm | 4000K

Options	Prod. no.
● anthracite	1003423



Product	Prod. no.
Spacer	
● anthracite	1002853
Lens 19°	
● black/chrome	1005205
Asymmetrical lens	
● black/chrome	1005206
Reflector 60°	
● chrome	1005207

ENOLA ROUND L WL, single

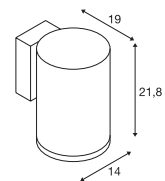

220-240V ~50/60Hz | 900mA
Total wattage: 36W
Material: aluminium/glass



Down 3300lm | 3000K | 3700lm | 4000K

Options	Prod. no.
● anthracite	1003440



Product	Prod. no.
Spacer	
● anthracite	1002853
Reflector 60°	
● chrome	1005263



1003441 727



ENOLA ROUND S UP/DOWN WL

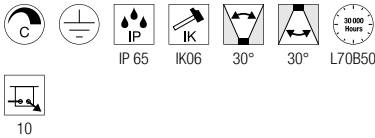
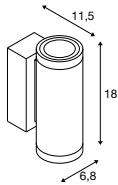

220-240V ~50/60Hz | 350mA
 Total wattage: 7.8W
 Material: aluminium/glass



Up	310lm	3000K	350lm	4000K
Down	310lm	3000K	350lm	4000K

Options	Prod. no.
● anthracite	1003424



Product	Prod. no.
Spacer	
● anthracite	1002853
Reflector 60°	
● chrome	1005262

ENOLA ROUND M UP/DOWN WL

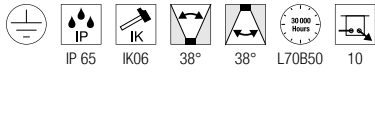
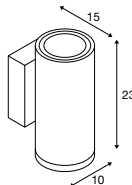

220-240V ~50/60Hz | 500mA
 Total wattage: 20W
 Material: aluminium/glass



Up	830lm	3000K	950lm	4000K
Down	830lm	3000K	950lm	4000K

Options	Prod. no.
● anthracite	1003425



Product	Prod. no.
Spacer	
● anthracite	1002853
Lens 19°	
● black/chrome	1005205
Asymmetrical lens	
● black/chrome	1005206
Reflector 60°	
● chrome	1005207

ENOLA ROUND L UP/DOWN WL

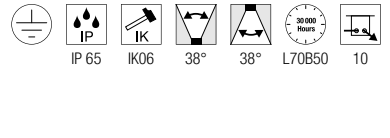
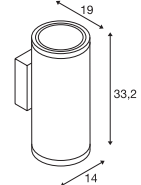

220-240V ~50/60Hz | 700mA
 Total wattage: 55W
 Material: aluminium/glass



Up	2700lm	3000K	3000lm	4000K
Down	2700lm	3000K	3000lm	4000K

Options	Prod. no.
● anthracite	1003441



Product	Prod. no.
Spacer	
● anthracite	1002853
Reflector 60°	
● chrome	1005263



1003416 729



1003417 729



ENOLA SQUARE S WL, single

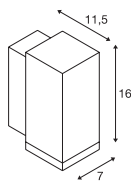

100-240V ~50/60Hz | 500mA
Total wattage: 6W
Material: aluminium/glass



Down 450lm | 3000K | 500lm | 4000K

Options	Prod. no.
● anthracite	1003416



Product	Prod. no.
Spacer	
● anthracite	1002853
Reflector 60°	
● chrome	1005262

ENOLA SQUARE M WL, single

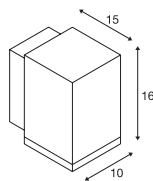

220-240V ~50/60Hz | 500mA
Total wattage: 11W
Material: aluminium/glass



Down 860lm | 3000K | 980lm | 4000K

Options	Prod. no.
● anthracite	1003417



Product	Prod. no.
Spacer	
● anthracite	1002853
Lens 19°	
● black/chrome	1005205
Asymmetrical lens	
● black/chrome	1005206
Reflector 60°	
● chrome	1005207

ENOLA SQUARE L WL, single

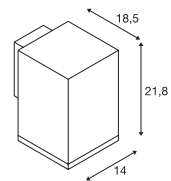

220-240V ~50/60Hz | 900mA
Total wattage: 36W
Material: aluminium/glass



Down 3300lm | 3000K | 3700lm | 4000K

Options	Prod. no.
● anthracite	1003437



Product	Prod. no.
Spacer	
● anthracite	1002853
Reflector 60°	
● chrome	1005263

ENOLA SQUARE S UP/DOWN WL

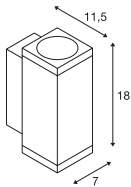

220-240V ~50/60Hz | 350mA
Total wattage: 7.8W
Material: aluminium/glass



Up	310lm	3000K	350lm	4000K
Down	310lm	3000K	350lm	4000K

Options	Prod. no.
● anthracite	1003418



Product	Prod. no.
Spacer	
● anthracite	1002853
Reflector 60°	
● chrome	1005262

ENOLA SQUARE M UP/DOWN WL

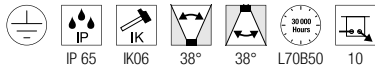
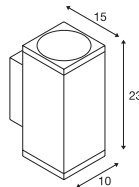

220-240V ~50/60Hz | 500mA
Total wattage: 20W
Material: aluminium/glass



Up	830lm	3000K	950lm	4000K
Down	830lm	3000K	950lm	4000K

Options	Prod. no.
● anthracite	1003419



Product	Prod. no.
Spacer	
● anthracite	1002853
Lens 19°	
● black/chrome	1005205
Asymmetrical lens	
● black/chrome	1005206
Reflector 60°	
● chrome	1005207

ENOLA SQUARE L UP/DOWN WL

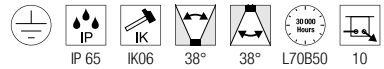
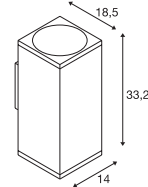

220-240V ~50/60Hz | 700mA
Total wattage: 55W
Material: aluminium/glass



Up	2700lm	3000K	3000lm	4000K
Down	2700lm	3000K	3000lm	4000K

Options	Prod. no.
● anthracite	1003438



Product	Prod. no.
Spacer	
● anthracite	1002853
Reflector 60°	
● chrome	1005262



ENOLA S, M, L
Reflector, 56°



S | H: 1.85 cm Diameter: 4.5 cm
M | H: 4.00 cm Diameter: 7.5 cm
L | H: 6.96 cm Diameter: 11 cm
Material: polycarbonate (PC)

ENOLA M
Lens, 19°



H: 3.8 cm
Diameter: 7.5 cm
Material: steel/polycarbonate (PC)

ENOLA M
Asymmetrical lens



H: 3 cm
Diameter: 7.5 cm
Material: steel/polycarbonate (PC)



Options	Prod. no.
● chrome S	1005262
● chrome M	1005207
● chrome L	1005263

Options	Prod. no.
● black/chrome	1005205

Options	Prod. no.
● black/chrome	1005206



EASY TO INSTALL

1

WALL MOUNTING.

Screw the mounting plate into the wall with the fixing screw.

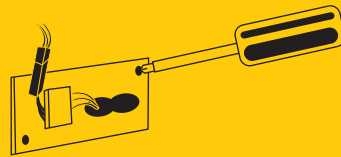

2

SIMPLY PLUG TOGETHER.

Connect the power supply plug connection to the LED lights.

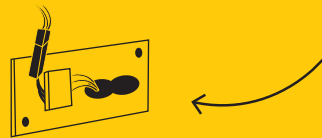

3

SIMPLE AND SECURE ASSEMBLY.

Hook the light into the useful guiding groove on the mounting plate and screw the light body to the mounting plate.



DONE!

Because efficiency always pays off, SLV lights are easy, quick and safe to install. On account of the fixed mounting plates, detachable lamp heads, spring clamps, through wiring, cable entries and various other features, they offer crucial benefits: in that they save you time, effort, and expense.

MOUNTABLE LAMP HEADS.

With our ENOLA® family, the lamp head can be separated from the mounting plate attached to the wall. This way, after mounting using the integrated nib and establishing the electrical connection using the plug connection, both hands remain free to securely screw on the lights.



PRACTICAL SPRING CLAMPS.

The cube-shaped SITRA CUBE wall lights offer wonderful modern simplicity. This means they are also fast and simple to install: Simply directly connect the connection cable (no tools required) and connect the mounting plate coupling to the light connector – done!



FEED-THROUGH WIRING.

Our QUADRULO wall and ceiling lights show how simply through-wiring functions in practice. Two cable entries in a figure of 8 configuration are provided in the light's baseplate. The spring clamp also has two connection options. This means that multiple lights can be quickly and simply installed simultaneously.





229532 735



234515 735



THEO UP/DOWN
WL, QPAR51

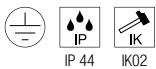
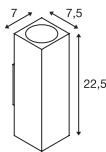

220-240V ~50/60Hz
Material: aluminium/glass



Base: 2xGU10

Options	Prod. no.
● anthracite	229535
○ white	229531
● grey	229532



LED GU10 51mm | 6W | 38°
2700K | 450lm | EEK=F
6kWh/1000h



Prod. no.: 1005077

BIG THEO BEAM UP/
FLOOD DOWN
WL

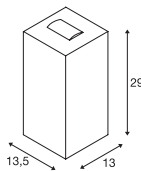

220-240V ~50/60Hz | 500mA
Total wattage: 29W
Material: aluminium/glass



Up 130lm | 3000K
Down 2000lm | 3000K

Options	Prod. no.
● anthracite	234515

BIG THEO UP/DOWN
WL, QPAR111

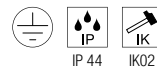
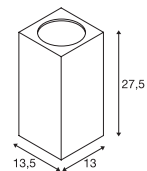

220-240V ~50/60Hz
Material: aluminium/glass



Base: 2xGU10

Options	Prod. no.
● anthracite	229575
● grey	229574



QPAR111 | 12.5W | 10°
3000K | 950lm | EEK=F
13kWh/1000h



Prod. no.: 1005278

**BIG THEO FLOOD UP/DOWN
WL**

**THEO
WL, QPAR51**

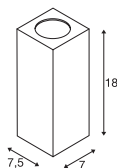
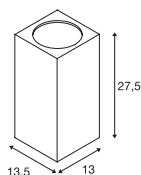

220-240V ~50/60Hz | 1000mA
Total wattage: 42W
Material: aluminium/glass

220-240V ~50/60Hz
Material: aluminium/glass



Up 2000lm | 3000K
Down 2000lm | 3000K

Base: 1xGU10

Options	Prod. no.
● anthracite	234505

Options	Prod. no.
● anthracite	229525
● grey	229524

 LED GU10 51mm | 6W | 38°
2700K | 450lm | EEK=F
6kWh/1000h  
Prod. no.: 1005077



234505 736





BIG THEO
WL, QPAR111

BIG THEO
WL

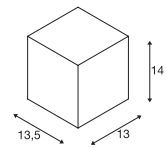
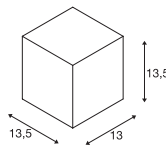
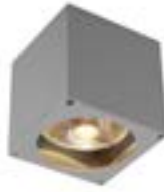

IP 44

220-240V ~50/60Hz
Material: aluminium/glass



Base: 1xGU10

Options	Prod. no.
● anthracite	229565
● grey	229564



100-277V ~50/60Hz | 500mA
Total wattage: 21W
Material: aluminium/glass



Down

2000lm | 3000K

Options	Prod. no.
● anthracite	234525



QPAR111 | 12.5W | 10°
3000K | 950lm | EEK=F
13kWh/1000h



Prod. no.: 1005278

234525 737



1002032 739



SITRA S
WL, single, square

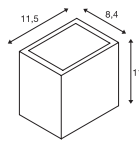

100-277V ~50/60Hz | 500mA
Total wattage: 11W
Material: aluminium



Up	550lm	3000K	635lm	4000K
Down	550lm	3000K	635lm	4000K

Options	Prod. no.
● anthracite	1002032
○ white	1002033
● rust	1002034

SITRA S
WL, single, square

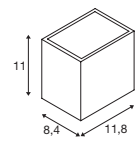

220-240V ~50/60Hz | 500mA
Total wattage: 6.2W
Material: aluminium/glass



Down	580lm	3000K	620lm	4000K
------	-------	-------	-------	-------

Options	Prod. no.
● anthracite	1005148
○ white	1005149
● rust	1005150



232531 741

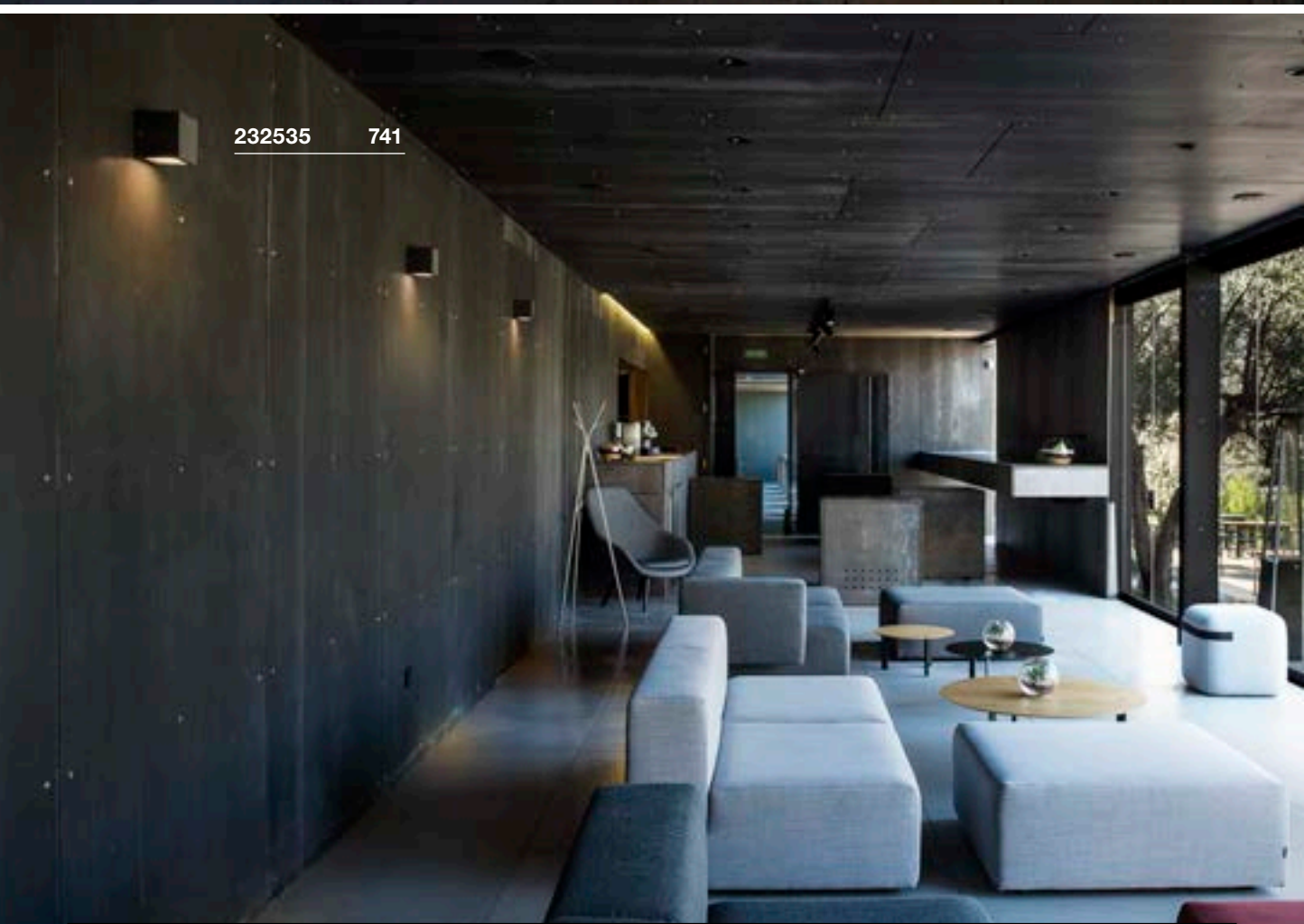

232535 741



SITRA M
WL, up/down, square

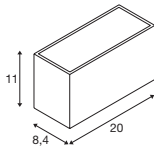

220-240V ~50/60Hz | 350mA
Total wattage: 14W
Material: aluminium



Up	850lm	3000K	940lm	4000K
Down	850lm	3000K	940lm	4000K

Options	Prod. no.
● anthracite 1700 / 1880lm	1005151
○ white 1700 / 1880lm	1005153
● rust 1600 / 1700lm	1005154

SITRA L
WL, up/down, square

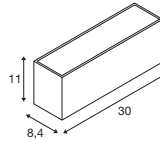

220-240V ~50/60Hz | 600mA
Total wattage: 24W
Material: aluminium



Up	1400lm	3000K	1530lm	4000K
Down	1400lm	3000K	1530lm	4000K

Options	Prod. no.
● anthracite	1005155
○ white	1005156
● rust	1005157

SITRA CUBE
WL, TCR-TSE

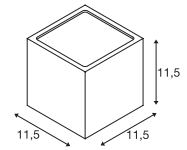

220-240V ~50/60Hz
Material: aluminium/glass



Base: 2xG53 Max. diameter: 7.5 cm L: 2.7 cm

Options	Prod. no.
● anthracite	232535
○ white	232531
● rust	232537



LED GX53 | 6.1W | 120°
3000K | 490lm | EEK=G
6kWh/1000h



Prod. no.: 1005271

GRAFIT
WL, round, sensor, E27

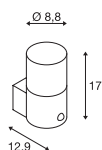

GRAFIT
WL, round, E27

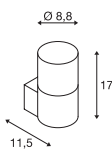

220-240V ~50/60Hz
Material: aluminium/acrylic



Base: 1xE27 Max. diameter: 6 cm L: 11.5 cm

Options

Prod. no.

- anthracite

1006179



LED E27 | 8W | 240°
3000K | 880lm | EEK=E
8kWh/1000h

Prod. no.: **1005289**



220-240V ~50/60Hz
Material: aluminium/acrylic



Base: 1xE27 Max. diameter: 6 cm L: 11.5 cm

Options

Prod. no.

- anthracite

1006178



A60 | 7.5W | 320°
2700K | 800lm | EEK=F
8kWh/1000h

Prod. no.: **1005303**

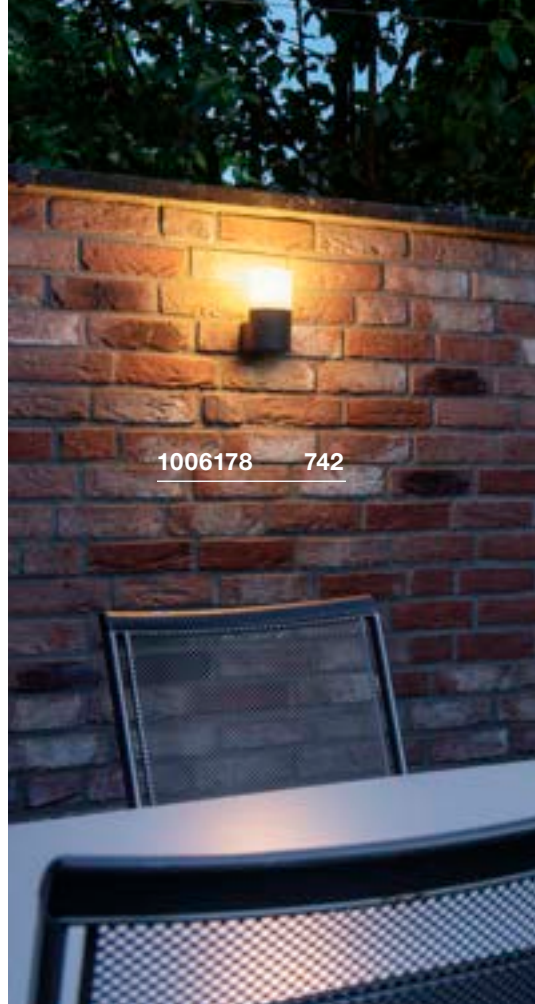

1006178 742





GRAFIT
WL, square, sensor, E27

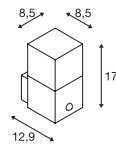

GRAFIT
WL, square, E27

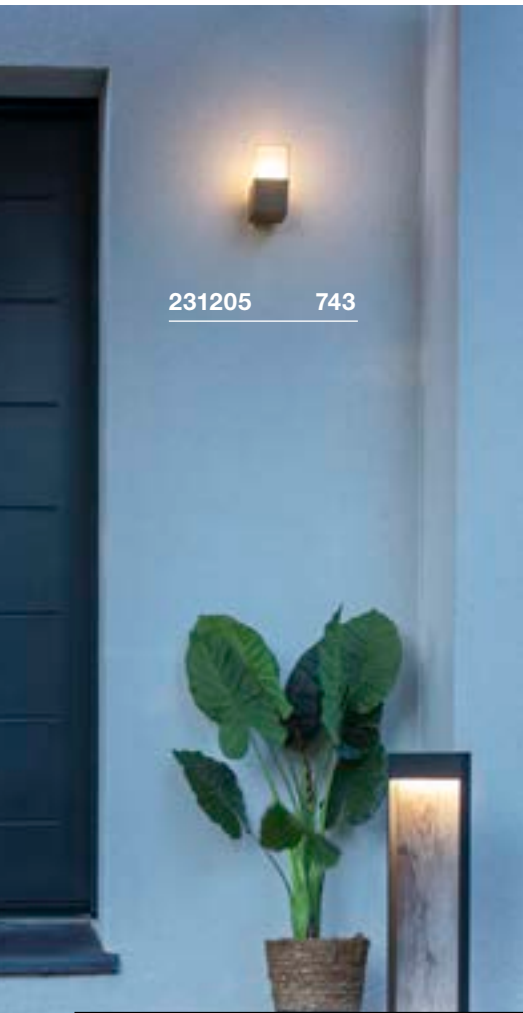
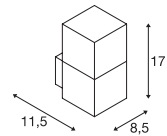

231205 743



220-240V ~50/60Hz
Material: aluminium/acrylic



Base: 1xE27 Max. diameter: 6 cm L: 11.5 cm

Options	Prod. no.
● anthracite	1006183



A60 | 7.5W | 320°
2700K | 800lm | EEK=F
8kWh/1000h

Prod. no.: 1005303



220-240V ~50/60Hz
Material: aluminium/plastic



Base: 1xE27 Max. diameter: 6 cm L: 11.5 cm

Options	Prod. no.
● anthracite	231205



A60 | 7.5W | 320°
2700K | 800lm | EEK=F
8kWh/1000h

Prod. no.: 1005303



QUADRULO WL



NEW

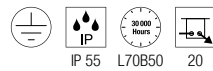
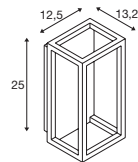

100-277V ~50/60Hz | 350mA
Total wattage: 7.4W
Material: aluminium/polyvinyl chloride (PVC)



Down 270lm | 280lm | 3000K

Options	Prod. no.
● anthracite 270lm	1005201
● anthracite/wood 280lm	1007207 ●



1002402 745

QUADRULO SENSOR
WL, E27

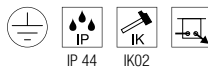
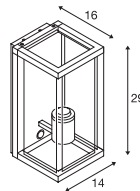

220-240V ~50/60Hz
Material: aluminium/glass

SOCKET INSIDE <15 W

Base: 1xE27 Max. diameter: 8 cm L: 18 cm

Options	Prod. no.
● anthracite	1002402



LED E27 | 7.5W | 320°
2500K | 700lm | EEK=F
8kWh/1000h

Prod. no.: 1005265



QUADRULO
WL, E27

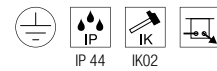
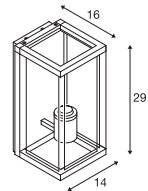

220-240V ~50/60Hz
Material: aluminium/glass

SOCKET INSIDE <15 W

Base: 1xE27 Max. diameter: 8 cm L: 18 cm

Options	Prod. no.
● anthracite	1002403



LED E27 | 7.5W | 320°
2500K | 700lm | EEK=F
8kWh/1000h

Prod. no.: 1005265



1002403 745

MERIDIAN
WL, E27

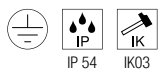
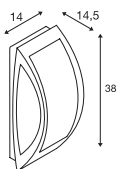

220-240V ~50/60Hz
Material: aluminium/polycarbonate (PC)



Base: 1xE27 Max. diameter: 7 cm L: 17.5 cm

Options	Prod. no.
● anthracite	230445
● grey	230444



LED E27 | 8W | 240°
3000K | 880lm | EEK=E
8kWh/1000h

Prod. no.: 1005289



MERIDIAN BOX
WL, E27

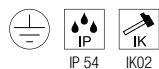
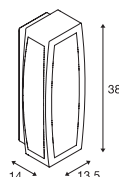

220-240V ~50/60Hz
Material: aluminium/polycarbonate (PC)



Base: 1xE27 Max. diameter: 7 cm L: 17.5 cm

Options	Prod. no.
● anthracite	230045
● grey	230044



| 13.5W | 240°
4000K | 1600lm | EEK=E
14kWh/1000h

Prod. no.: 1005308





230445 746

MERIDIAN BOX SENSOR
WL, E27

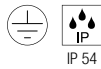
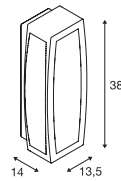

220-240V ~50/60Hz
Material: aluminium/polycarbonate (PC)

- The ambient brightness and operating time can be adjusted.



Base: 1xE27 Max. diameter: 7 cm L: 17.5 cm

Options	Prod. no.
● anthracite	230085
● grey	230084



LED E27 | 8W | 240°
3000K | 880lm | EEK=E
8kWh/1000h

Prod. no.: 1005289

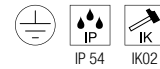

220-240V ~50/60Hz
Material: aluminium/polycarbonate (PC)



Base: 1xE27 Max. diameter: 7 cm L: 17.5 cm

Options	Prod. no.
● anthracite	230655
● rust	230657



LED E27 | 7.5W | 320°
2500K | 700lm | EEK=F
8kWh/1000h

Prod. no.: 1005265



230655 747

1004748 749

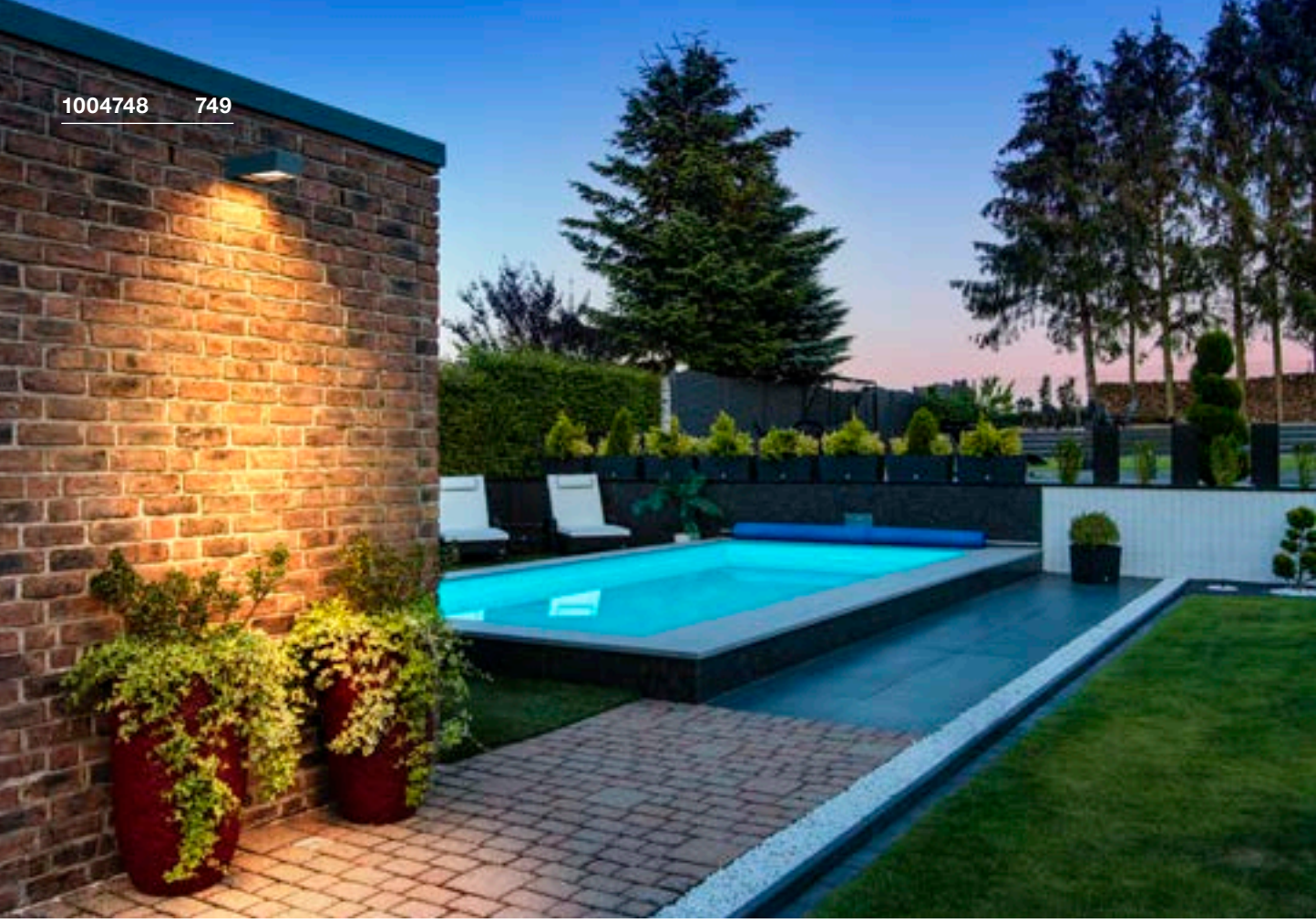

1006314 749

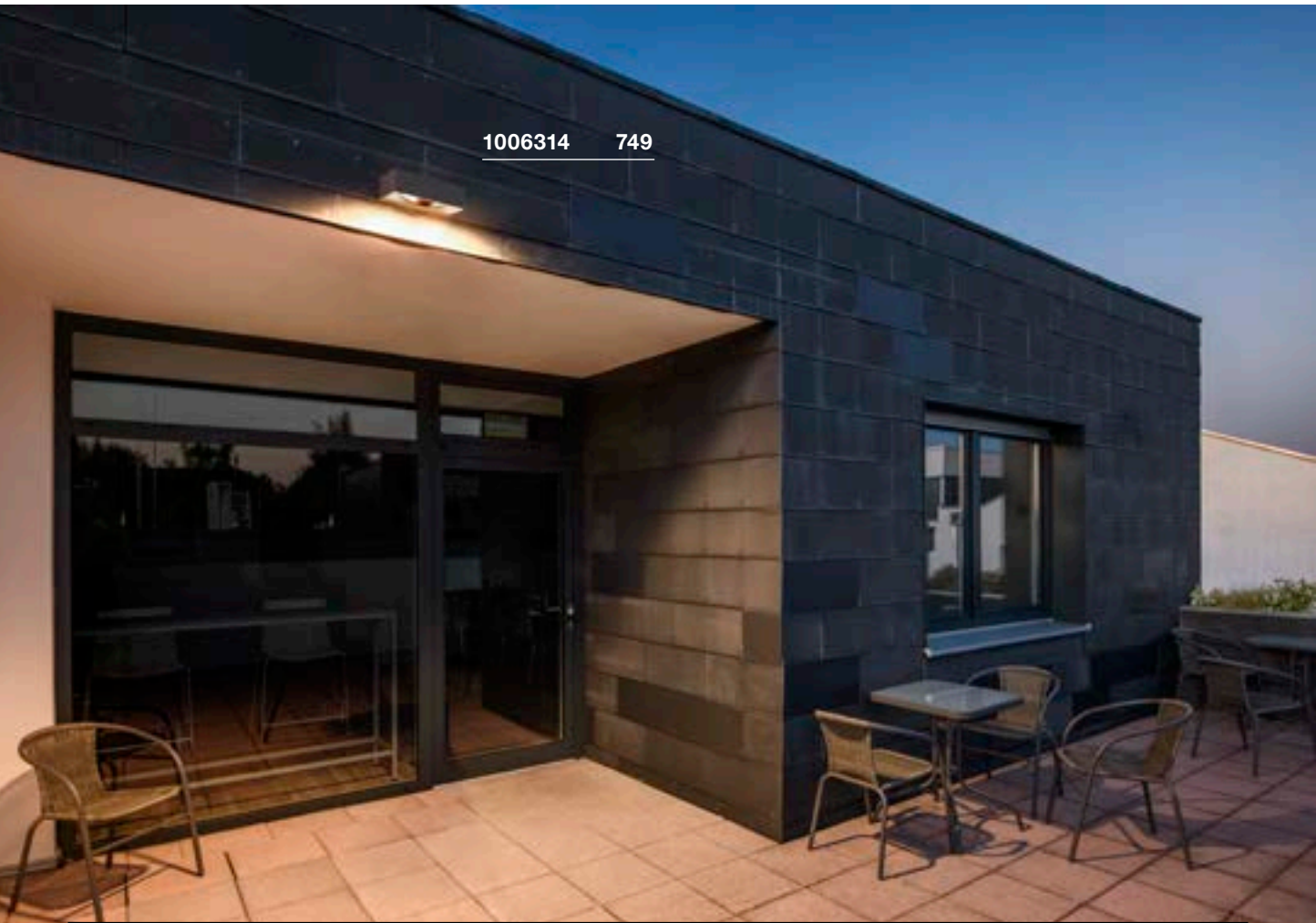



ESKINA FRAME WL

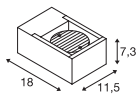

220-240V ~50/60Hz | 350mA
 Total wattage: 15W
 Material: aluminium



Down	1100lm 3000K	1200lm 4000K
------	----------------	----------------

Options	Prod. no.
● anthracite	1004747

ESKINA FRAME WL, double

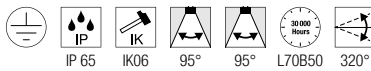
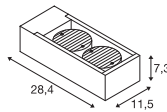

220-240V ~50/60Hz | 700mA
 Total wattage: 27W
 Material: aluminium



Spot 1	1100lm 3000K	1200lm 4000K
Spot 2	1100lm 3000K	1200lm 4000K

Options	Prod. no.
● anthracite	1004748

ESKINA FRAME WL, double

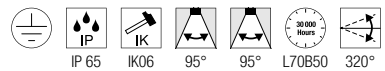
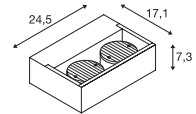

220-240V ~50/60Hz | 700mA
 Total wattage: 27W
 Material: aluminium



Spot 1	1100lm 3000K	1200lm 4000K
Spot 2	1100lm 3000K	1200lm 4000K

Options	Prod. no.
● anthracite	1006314

1005443 751





BOOKAT WL

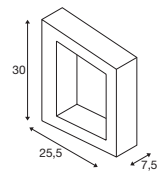

1005441 683

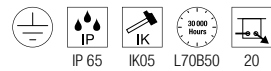

100-277 V ~50/60 Hz | 700 mA
Total wattage: 15W
Material: aluminium



Down 920lm | 3000K | 990lm | 4000K

Options

● anthracite

Prod. no.

1005443

**BIG QUAD
WL**

**QUAD
WL**

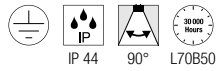
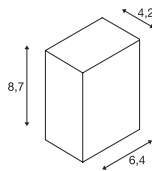
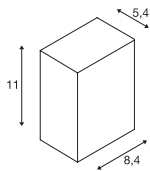

100-240V ~50/60Hz | 350mA
Total wattage: 4.5W
Material: aluminium/glass

200-240V ~50/60Hz | 700mA
Total wattage: 4.6W
Material: aluminium/glass



Down 260lm | 3000K



Down 80lm | 3000K
100lm | 3000K

Options	Prod. no.
● anthracite	232435

Options	Prod. no.
● anthracite	
80lm	232465
○ white	
100lm	232461





QUAD UP/DOWN 15
WL

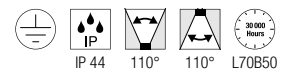
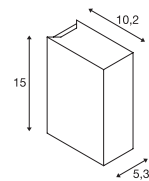

100-277V ~50/60Hz | 350mA
Total wattage: 8W
Material: aluminium/glass



Up	260lm	3000K
Down	260lm	3000K

Options	Prod. no.
● anthracite 520lm	232445
○ white 580lm	232441



1005126 755





BIG QUAD UP/DOWN WL

BIG QUAD WL

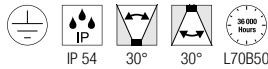
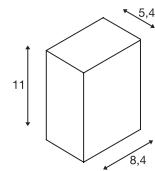
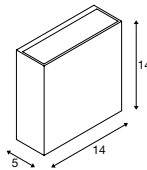

220-240V ~50/60Hz | 500mA
 Total wattage: 8.2W
 Material: aluminium/glass

100-240V ~50/60Hz | 350mA
 Total wattage: 4.5W
 Material: aluminium/glass



Up 320lm | 3000K
 Down 320lm | 3000K

Down 290lm | 3000K

Options	Prod. no.
<input checked="" type="radio"/> anthracite	1005126
<input type="radio"/> white	1005125

Options	Prod. no.
<input type="radio"/> white	232431

RUSTY® UP/DOWN
WL, square

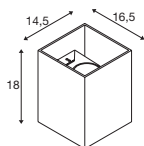

220-240V ~50/60Hz | 350mA
Total wattage: 14W
Material: FeCSi stainless steel/aluminium



Up	259lm	3000K	260lm	4000K
Down	285lm	3000K	288lm	4000K

Options	Prod. no.
● rust/anthracite	1004650

RUSTY® UP/DOWN
WL, round

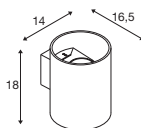

220-240V ~50/60Hz | 350mA
Total wattage: 14W
Material: FeCSi stainless steel/aluminium



Up	249lm	3000K	254lm	4000K
Down	267lm	3000K	271lm	4000K

Options	Prod. no.
● rust/anthracite	1004651

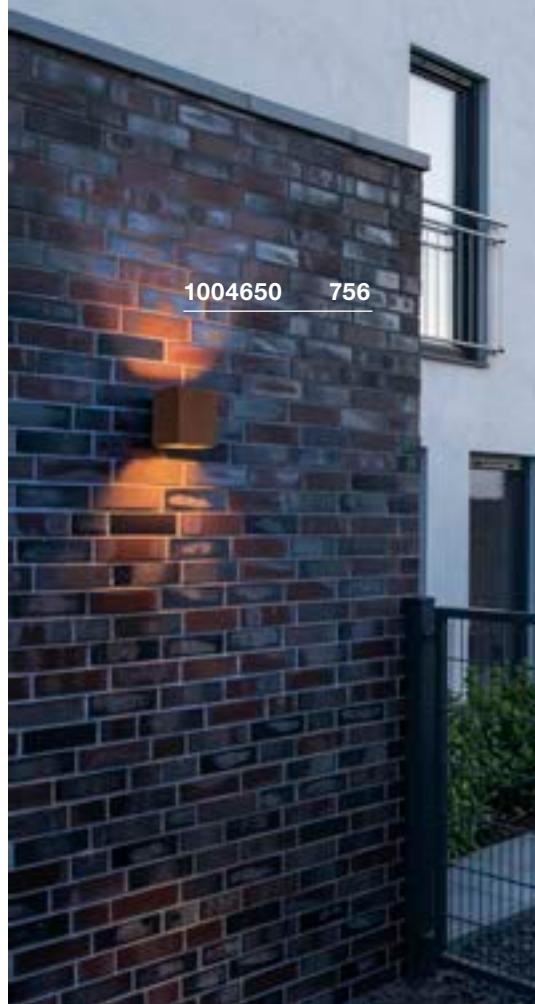



OVALISK SENSOR WL

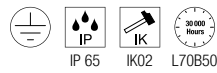
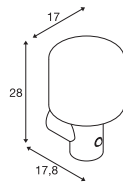

220-240V ~50/60Hz | 500mA
 Total wattage: 9.6W
 Material: aluminium/glass



Down 580lm | 3000K | 630lm | 4000K

Options	Prod. no.
● anthracite	1004679

OVALISK WL

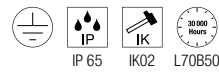
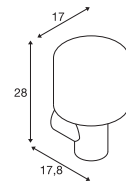

220-240V ~50/60Hz | 500mA
 Total wattage: 9.2W
 Material: aluminium/glass



Down 580lm | 3000K | 630lm | 4000K

Options	Prod. no.
● anthracite	1004678



1004679 757

PEMA®
WL

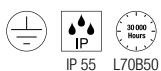
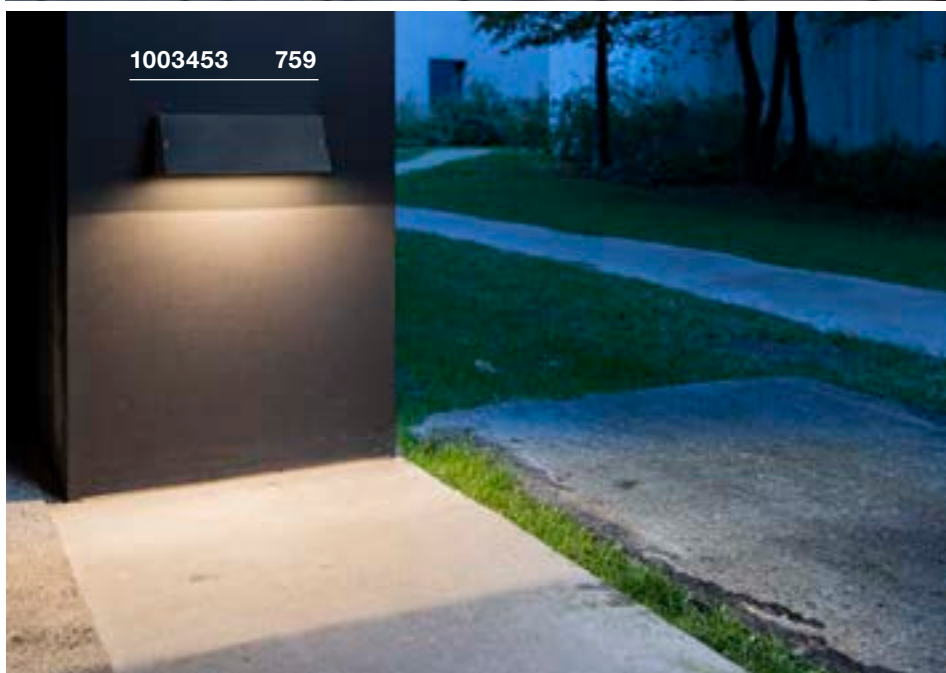
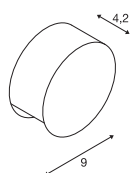
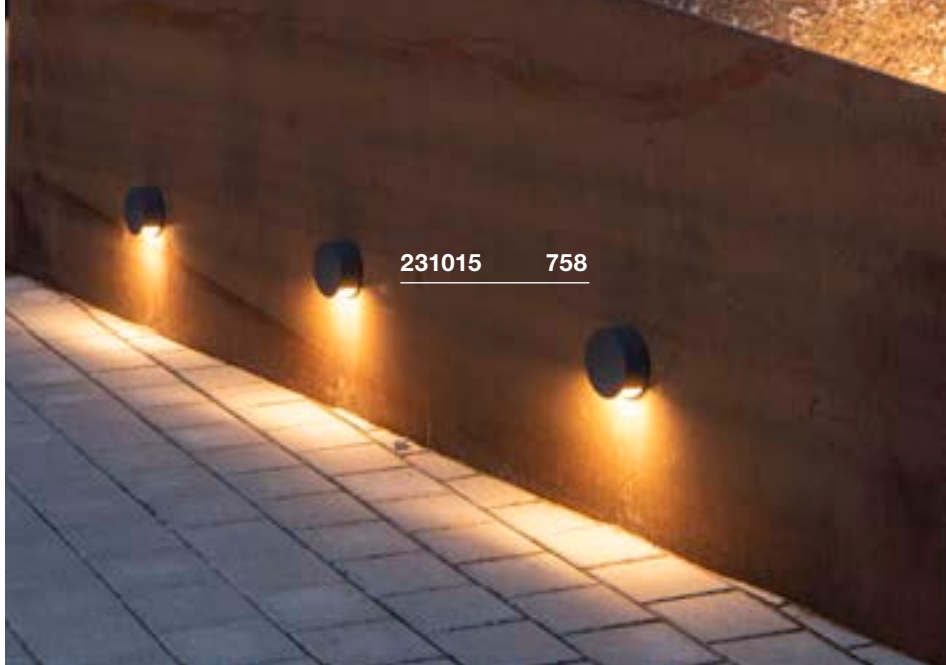

220-240V ~50/60Hz
Total wattage: 3.8W
Material: aluminium/polycarbonate (PC)

- Protection rating IP55 only when mounted with light emission downwards.



Down 170lm | 3000K

Options	Prod. no.
● anthracite	231015
○ white	231010
● grey	231012





PEMA®
WL

PEMA®
WL

PEMA®
WL, E27

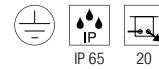
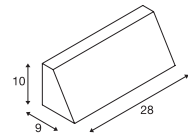
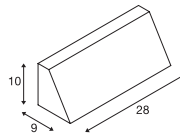
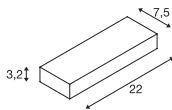

220-240V ~50/60Hz
Total wattage: 7.7W
Material: aluminium/glass

100-277V ~50/60Hz | 350mA
Total wattage: 14W
Material: aluminium/glass

220-240V ~50/60Hz
Material: aluminium/glass



Down 640lm | 3000K



Down 1340lm | 3000K | 1420lm | 4000K



Base: 1xE27 Max. diameter: 4.5 cm | L: 21 cm

Options	Prod. no.
● anthracite	1002069
○ white	1002070

Options	Prod. no.
● black	1003453
● grey	1003454

Options	Prod. no.
● black	230030
● grey	230034



LED E27 | 8W | 240°
3000K | 880lm | EEK=E
8kWh/1000h



Prod. no.: 1005289

FLATT SENSOR WL

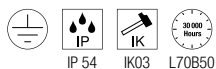
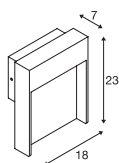

100-240V ~50/60Hz | 300mA
Total wattage: 13W
Material: aluminium/aluminium



Down 500lm | 3000K | 550lm | 4000K

Options	Prod. no.
● anthracite 500 / 530lm	1002954
●● anthracite/brown 500 / 550lm	1002955

FLATT WL

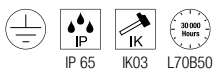
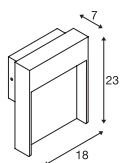

100-240V ~50/60Hz | 300mA
Total wattage: 13W
Material: aluminium/aluminium



Down 500lm | 3000K | 530lm | 4000K

Options	Prod. no.
● anthracite 500 / 530lm	1002952
●● anthracite/brown 500 / 550lm	1002953





1002955 760



ASTINA
WL, QPAR51

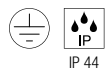
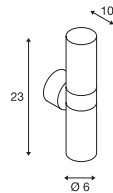

220-240V ~50/60Hz
Material: aluminium/glass



Base: 2xGU10 max. L: 9 cm

Options	Prod. no.
● anthracite	228775
○ white	228771
● aluminium	228776



LED GU10 51mm | 6W | 38°
2700K | 450lm | EEK=F
6kWh/1000h

Prod. no.: 1005075



ASTINA STEEL
WL, QPAR51

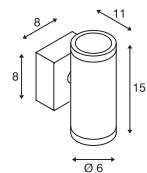

220-240V ~50/60Hz
Material: stainless steel 304



Base: 2xGU10 Max. diameter: 5.1 cm | L: 5.7 cm

Options	Prod. no.
● Stainless steel	233302



LED GU10 51mm | 6W | 38°
2700K | 450lm | EEK=F
6kWh/1000h

Prod. no.: 1005075

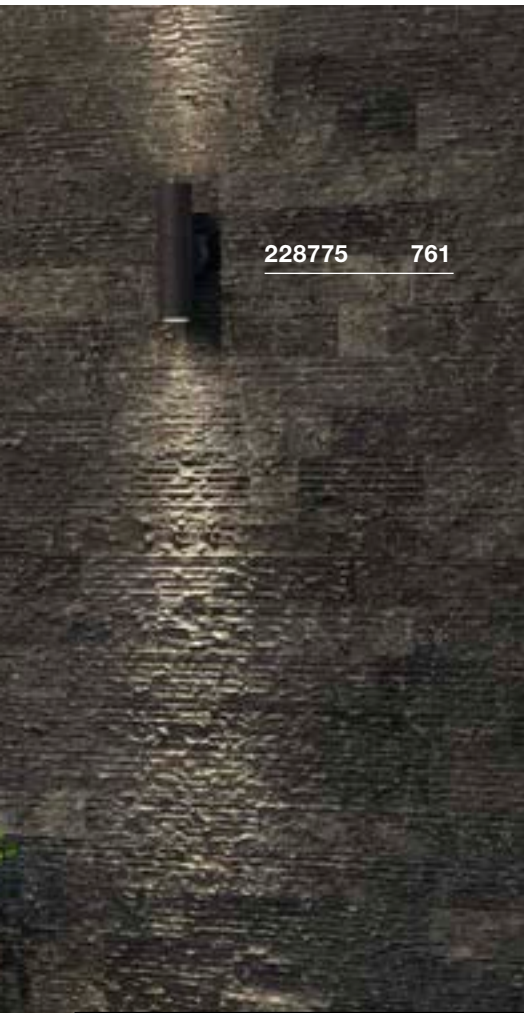

228775 761

ANGOLUX SENSOR
WL

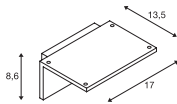

100-240V ~50/60Hz | 240mA
Total wattage: 9.8W
Material: aluminium

- Detection angle 120°, max. detection distance 9m, sensitivity setting
- IP44 protection rating only when mounted with light emission downwards.



Down 750lm | 3000K

Options	Prod. no.
● anthracite	1001969
○ white	1001970

ANGOLUX
WL

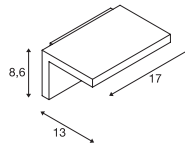

220-240V ~50/60Hz | 80mA
Total wattage: 6.8W
Material: aluminium

- IP44 protection rating only when mounted with light emission downwards.



Down 550lm | 3000K

Options	Prod. no.
● anthracite	231355
○ white	231351

1001969 762

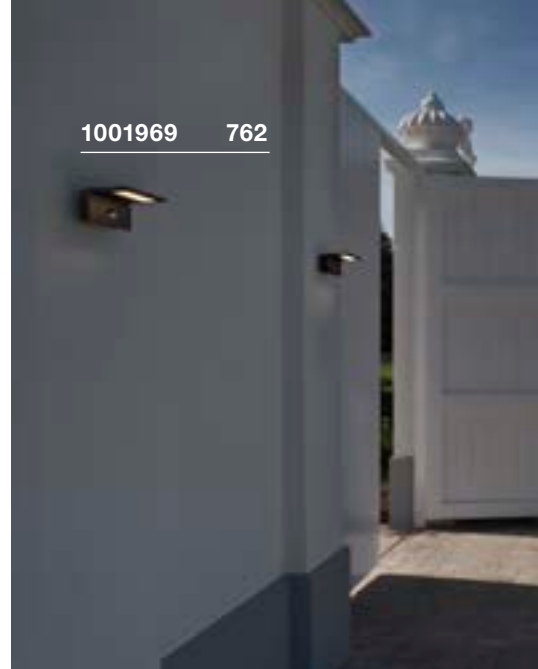

1002504 763



1002505 763

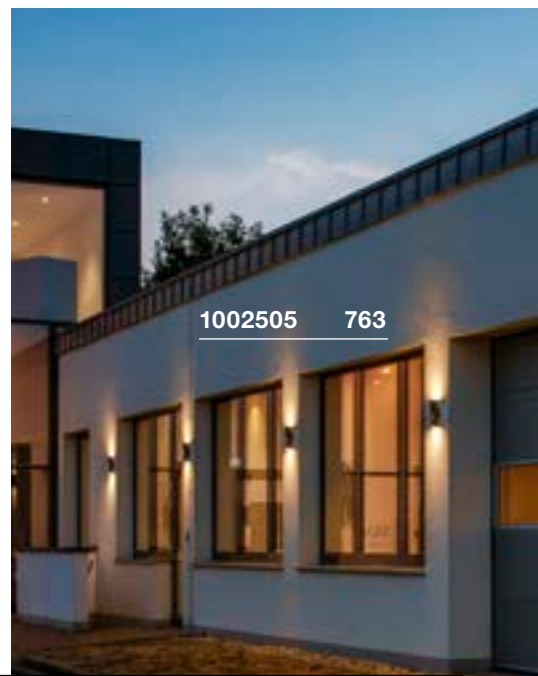



VILUA S
WL

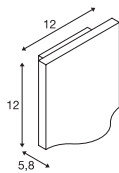

100-277 V ~50/60 Hz | 700 mA
Total wattage: 9W
Material: aluminium/glass



Down 405lm | 3000K

Options	Prod. no.
● anthracite	1002503

VILUA L
WL

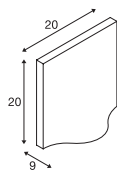

100-277V ~50/60Hz | 350mA
Total wattage: 17W
Material: aluminium/glass



Down 940lm | 3000K

Options	Prod. no.
● anthracite	1002504

VILUA
UP/DOWN, WL

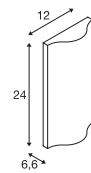

100-277 V ~50/60 Hz | 700 mA
Total wattage: 16W
Material: aluminium/glass



Up 400lm | 3000K
Down 400lm | 3000K

Options	Prod. no.
● anthracite	1002505

MYRA UP/DOWN
WL, QPAR51

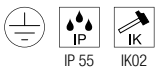
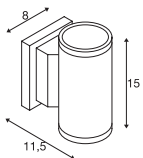

220-240V ~50/60Hz
Material: aluminium/glass



Base: 2xGU10 Max. diameter: 5.1 cm L: 5.7 cm

Options	Prod. no.
● anthracite	233115
● grey	233114

LED GU10 51mm | 6W | 38°
2700K | 450lm | EEK=F
6kWh/1000h



Prod. no.: **1005077**

⊕

Product	Prod. no.
Surface-mounting frames	
● anthracite	233215
● grey	233214

233114 764

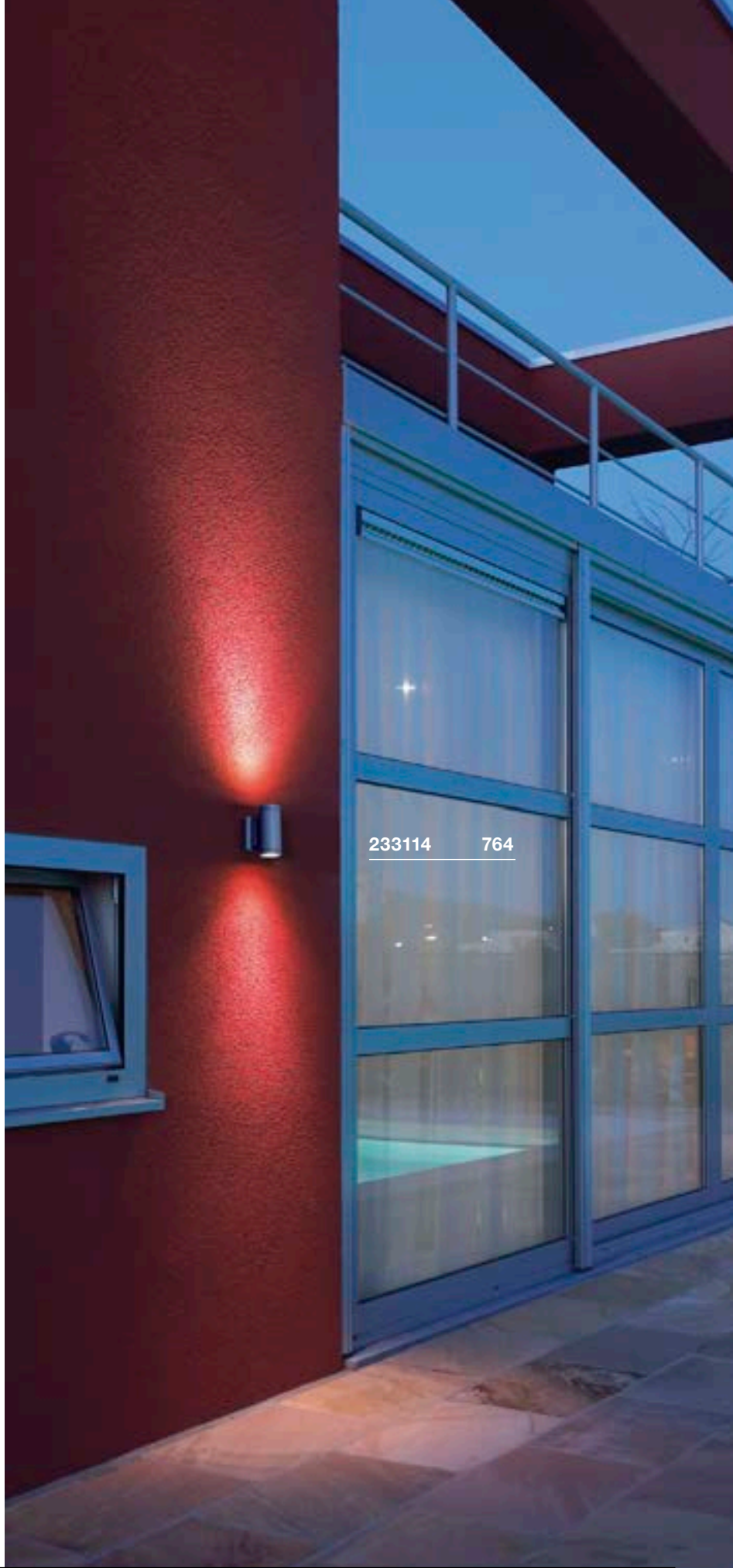



SITRA UP/DOWN
WL

SITRA UP/DOWN
WL, TCR-TSE

230362 765

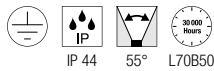
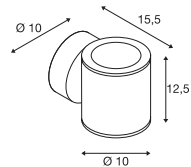
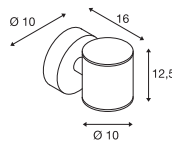

IP 44 55° L70B50



IP 44

220-240V ~50/60Hz
Total wattage: 18W
Material: aluminium/glass

220-240V ~50/60Hz
Material: aluminium/glass



Up	488lm	3000K
Down	488lm	3000K



Base: 2xG53 Max. diameter: 7.5 cm L: 3.5 cm

Options	Prod. no.
● anthracite	1002018

Options	Prod. no.
● anthracite	230365



LED GX53 | 6.1W | 120°
3000K | 490lm | EEK=G
6kWh/1000h



Prod. no.: 1005271



1000334 767



ROX
WL, QPAR111

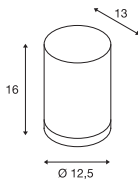

220-240V ~50/60Hz
Material: aluminium/glass



Base: 1xGU10

Options	Prod. no.
● aluminium	1000333



QPAR111 | 12.5W | 10°
3000K | 950lm | EEK=F
13kWh/1000h

Prod. no.: 1005278



ROX UP/DOWN
WL, QPAR111

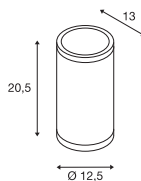

220-240V ~50/60Hz
Material: aluminium/glass



Base: 2xGU10

Options	Prod. no.
● aluminium	1000334



QPAR111 | 12.5W | 10°
3000K | 950lm | EEK=F
13kWh/1000h

Prod. no.: 1005278



DELWA
WL

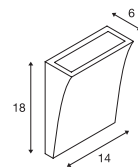

220-240V ~50/60Hz | 700mA
Total wattage: 10W
Material: aluminium/glass



Down

840lm | 3000K

Options	Prod. no.
● anthracite	1000342
○ white	1000340

SLOTS
WL

WALLYX
WL, QPAR51

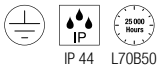
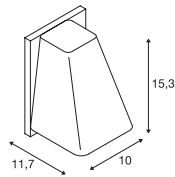
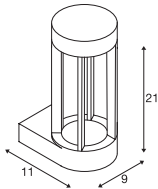

220-240V ~50/60Hz
Total wattage: 4.5W
Material: aluminium/glass



Down 140lm | 3000K

Options	Prod. no.
● anthracite	231805
● rust	231807



220-240V ~50/60Hz
Material: aluminium/glass



Base: 1xGU10 max. L: 7.6 cm

Options	Prod. no.
● anthracite	227195



LED GU10 51mm | 6W | 38°
2700K | 450lm | EEK=F
6kWh/1000h



Prod. no.: 1005077

227195 768

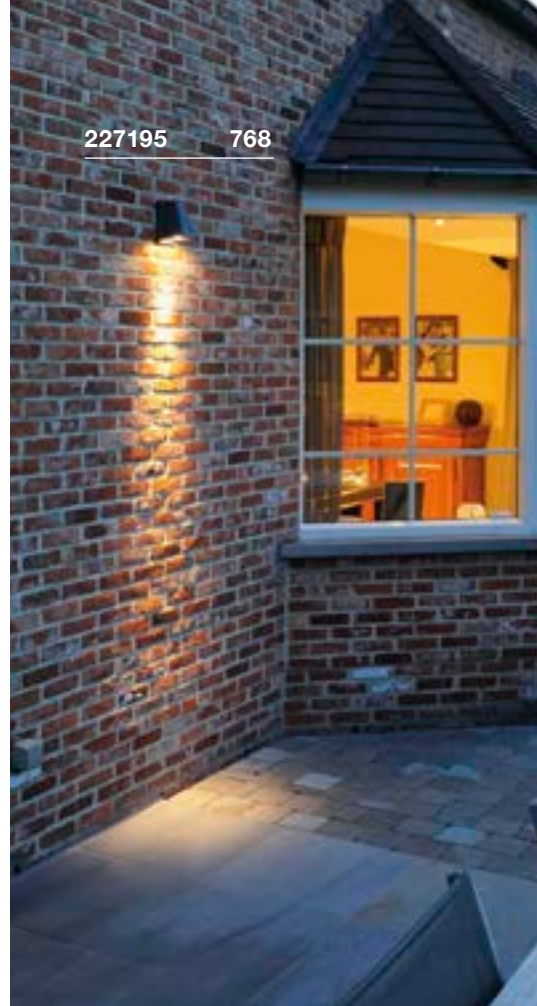



DOWNUNDER OUT WL, round

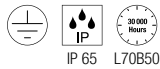
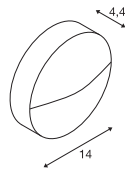

100-240V ~50/60Hz | 500mA
Total wattage: 4.3W
Material: aluminium



Down 150lm | 3000K | 160lm | 4000K

Options	Prod. no.
● anthracite	1002868

DOWNUNDER OUT WL, square

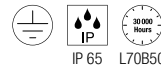
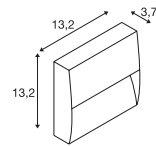

100-240V ~50/60Hz | 500mA
Total wattage: 4.3W
Material: aluminium



Down 150lm | 3000K | 160lm | 4000K

Options	Prod. no.
● anthracite	1002869

1002868 769

ABRIDOR SENSOR WL

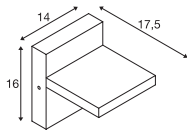

100-240V ~50/60Hz | 300mA
Total wattage: 12W
Material: aluminium



Down 950lm | 3000K | 980lm | 4000K

Options

- anthracite

Prod. no.

1002990

ABRIDOR WL

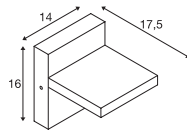

100-240V ~50/60Hz | 300mA
Total wattage: 12W
Material: aluminium



Down 950lm | 3000K | 980lm | 4000K

Options

- anthracite

Prod. no.

1002989

1002990 770



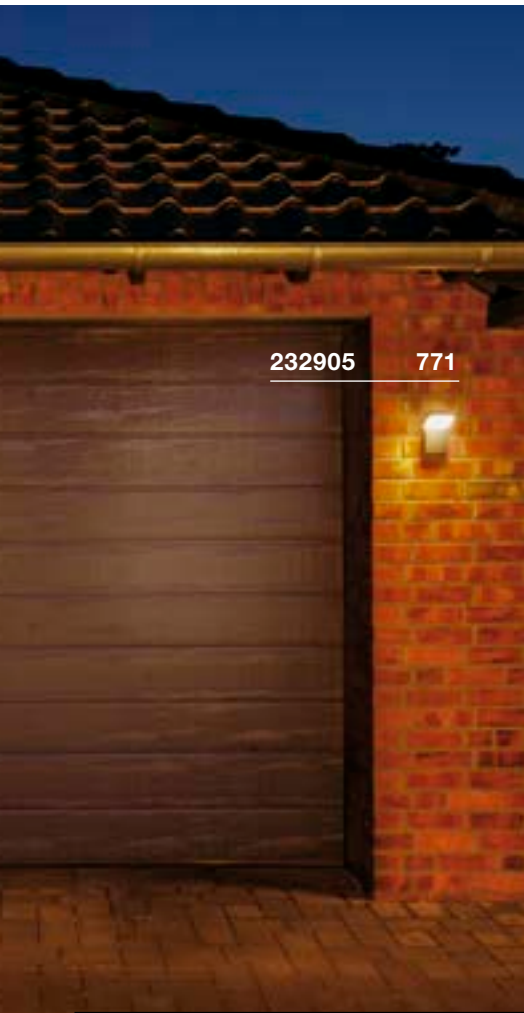

232905

771

ORDI SENSOR
WL

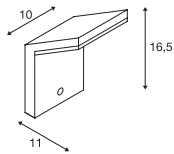

220-240V ~50/60Hz | 110mA
Total wattage: 9W
Material: aluminium



Down

740lm | 3000K

Options	Prod. no.
● anthracite	232915

ORDI
WL

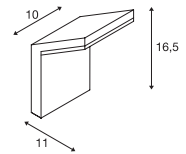

220-240V ~50/60Hz | 110mA
Total wattage: 9W
Material: aluminium



Down

740lm | 3000K

Options	Prod. no.
● anthracite	232905



232495 773



1002035 773



232485 773



**BOX-L
WL, E27**

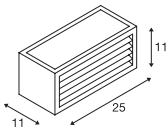

220-240V ~50/60Hz
Material: aluminium/acrylic



Base: 1xE27 Max. diameter: 6 cm L: 17.5 cm

Options	Prod. no.
● anthracite	232495
○ white	232491
● rust	232497



LED E27 | 8W | 240°
3000K | 880lm | EEK=E
8kWh/1000h



Prod. no.: **1005289**

**BOX-L
WL**

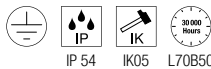
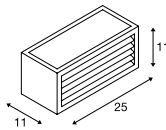

100-277V ~50/60Hz | 500mA
Total wattage: 19 W
Material: aluminium/acrylic



Down 600lm | 3000K

Options	Prod. no.
● anthracite	1002035

**BOX UP/DOWN
WL, QT-DE12**

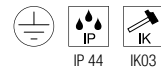
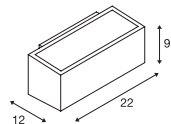

220-240V ~50/60Hz
Material: aluminium



Base: 1xR7s 78mm

Options	Prod. no.
● anthracite	232485



LED R7s | 9W | 330°
3000K | 1050lm | EEK=E
9kWh/1000h



Prod. no.: **1005287**



232101 775

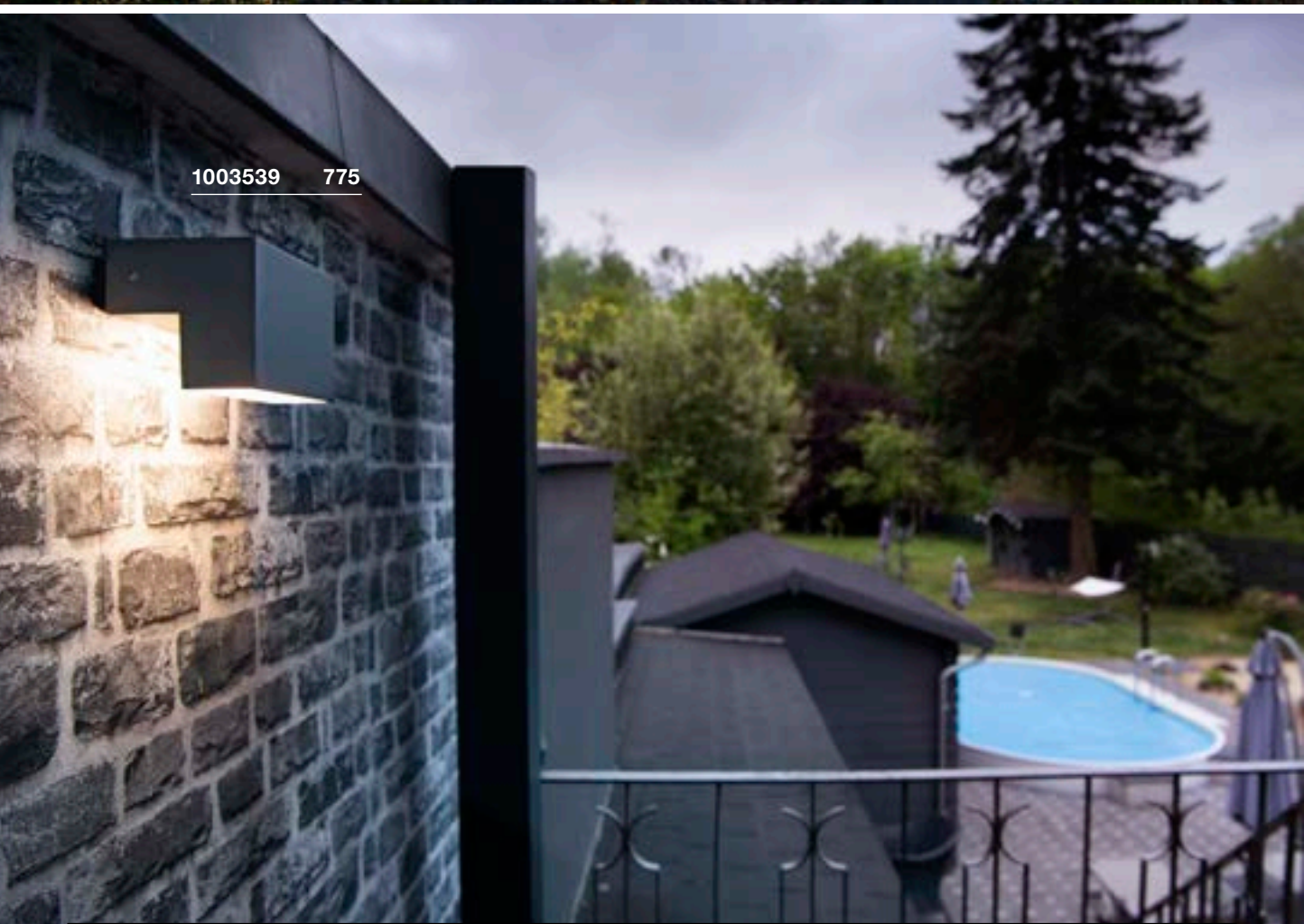

1003539 775



LOGS
WL

OUT-BEAM UP /
FLOOD DOWN
WL

L-LINE OUT
WL

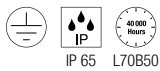
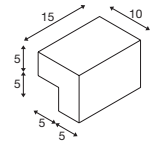
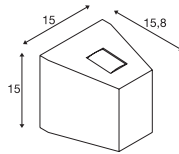
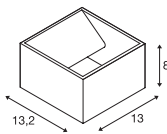

IP 65 L70B50

220-240V ~50/60Hz | 500mA
Total wattage: 9.5W
Material: aluminium



IP 44 IK03 80° 2° L70B50

220-240V ~50/60Hz | 500mA
Total wattage: 18W
Material: aluminium/glass



IP 65 IK02 L70B50 10

220-240V ~50/60Hz | 350mA
Total wattage: 7W
Material: aluminium/polycarbonate (PC)



Down 520lm | 3000K
800lm



Up 50lm | 3000K
Down 690lm | 3000K



Down 500lm | 3000K | 570lm | 4000K

Options	Prod. no.
● anthracite	
520lm	232105
○ white	
800lm	232101

Options	Prod. no.
● anthracite	229665
● grey	229664

Options	Prod. no.
● anthracite	1003539

232045 777





PHOTONIA
WL, E27

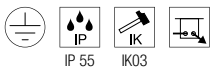
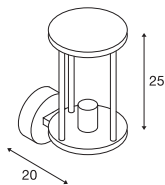

220-240V ~50/60Hz
Material: aluminium/glass



Base: 1xE27 Max. diameter: 9 cm L: 15 cm

Options	Prod. no.
● anthracite	232045

LED E27 | 7.5W | 320°
2500K | 700lm | EEK=F
8kWh/1000h



Prod. no.: 1005265

+

Product	Prod. no.
Spacer	
● anthracite	1002853

MOLAT
WL, E27

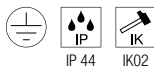
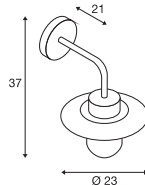

220-240V ~50/60Hz
Material: aluminium/glass



Base: 1xE27 Max. diameter: 6.5 cm L: 14.5 cm

Options	Prod. no.
● anthracite	1000820

A60 | 7.5W | 320°
2700K | 800lm | EEK=F
8kWh/1000h



Prod. no.: 1005303

GLOO PURE
WL, E27

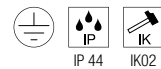
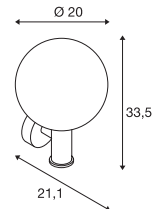

220-240V ~50/60Hz
Material: aluminium/glass



Base: 1xE27 Max. diameter: 4.8 cm L: 18 cm

Options	Prod. no.
● anthracite	1002002

LED E27 | 8W | 240°
4000K | 920lm | EEK=E
8kWh/1000h



Prod. no.: 1005290



1000336 779

F-POL
WL, E27

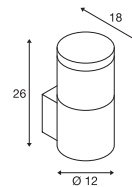

230355 779

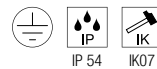

220-240V ~50/60Hz
Material: aluminium/polycarbonate (PC)

SOCKET
INSIDE <20
W

Base: 1xE27 Max. diameter: 5.1 cm L: 14 cm

Options	Prod. no.
● anthracite	231585



LED E27 | 8W | 240°
4000K | 920lm | EEK=E
8kWh/1000h



Prod. no.: 1005290



SQUARE
WL, E27

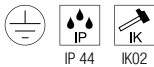
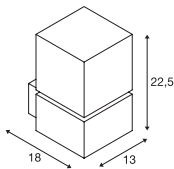

220-240V ~50/60Hz
Material: stainless steel 304



Base: 1xE27 Max. diameter: 7 cm L: 13 cm

Options	Prod. no.
● Stainless steel	1000336



A60 | 7.5W | 320°
2700K | 800lm | EEK=F
8kWh/1000h



Prod. no.: 1005303

KERAS ELT
WL, E27

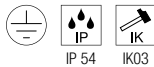
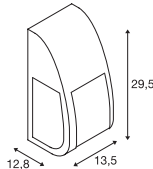

220-240V ~50/60Hz
Material: aluminium/polycarbonate (PC)



Base: 1xE27 Max. diameter: 7 cm L: 17.5 cm

Options	Prod. no.
● anthracite	227176



A60 | 7.5W | 320°
2700K | 800lm | EEK=F
8kWh/1000h



Prod. no.: 1005303

SITRA
WL, TCR-TSE

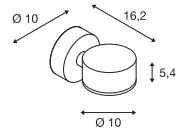

220-240V ~50/60Hz
Material: aluminium/glass



Base: 1xG53 Max. diameter: 7.5 cm L: 3.5 cm

Options	Prod. no.
● anthracite	230355



LED GX53 | 6.1W | 120°
3000K | 490lm | EEK=G
6kWh/1000h



Prod. no.: 1005271

RASCALI
WL

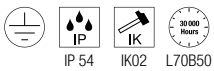
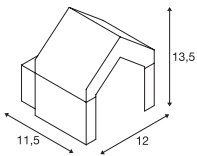

220-240V ~50/60Hz
Total wattage: 8W
Material: aluminium



Down 330lm | 3000K

Options	Prod. no.
● anthracite	1000797

IPERI
WL

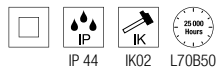
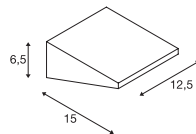

220-240V ~50/60Hz
Total wattage: 4.5W
Material: aluminium

- IP44 protection rating only when mounted with light emission downwards.



Down 400lm | 4000K

Options	Prod. no.
● black	231315

1000797 780





231315 781

QUADRASYL
WL, TCR-TSE

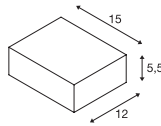

220-240V ~50/60Hz
Material: aluminium/glass



Base: 1xG53 Max. diameter: 7.5 cm L: 2.7 cm

Options	Prod. no.
● anthracite	232285



LED GX53 | 6.1W | 120°
3000K | 490lm | EEK=G
6kWh/1000h

Prod. no.: 1005271



SQUARE TURN
WL, G9

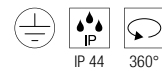
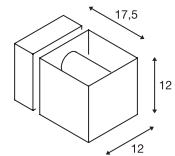

220-240V ~50/60Hz
Material: aluminium/glass



Base: 1xG69 Max. diameter: 3.5 cm L: 8 cm

Options	Prod. no.
● grey	1000335



LED G9 | 3.6W | 300°
3000K | 400lm | EEK=E
4kWh/1000h

Prod. no.: 1005286



1000335 781

1002905 783



233134 783





TODAY PRO Display

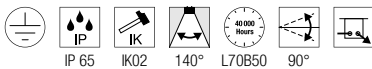
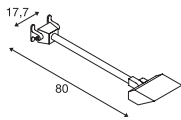

220-240V ~50/60Hz | 640mA
Total wattage: 29W
Material: aluminium



Down 2800lm | 4000K

Options	Prod. no.
● black	1000880
○ white	1000881

ESKINA D Display, PHASE

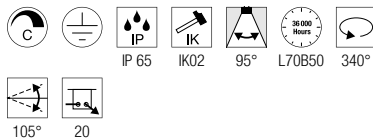
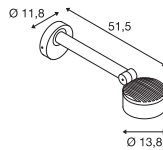

220-240V ~50/60Hz | 350mA
Total wattage: 14.5W
Material: aluminium

- CCT switch on light body



Down 1000lm | 3000K | 1000lm | 4000K

Options	Prod. no.
● anthracite	1002905

MYRA DISPLAY WL, curved, QPAR51

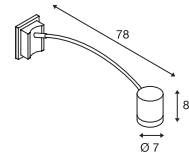

220-240V ~50/60Hz
Material: aluminium



Base: 1xGU10 Max. diameter: 5.1 cm | L: 5.7 cm

Options	Prod. no.
● anthracite	233135
● grey	233134



LED GU10 51mm | 6W | 38°
2700K | 450lm | EEK=F
6kWh/1000h



Prod. no.: 1005077



Product	Prod. no.
Surface-mounting frames	
● anthracite	233215
● grey	233214

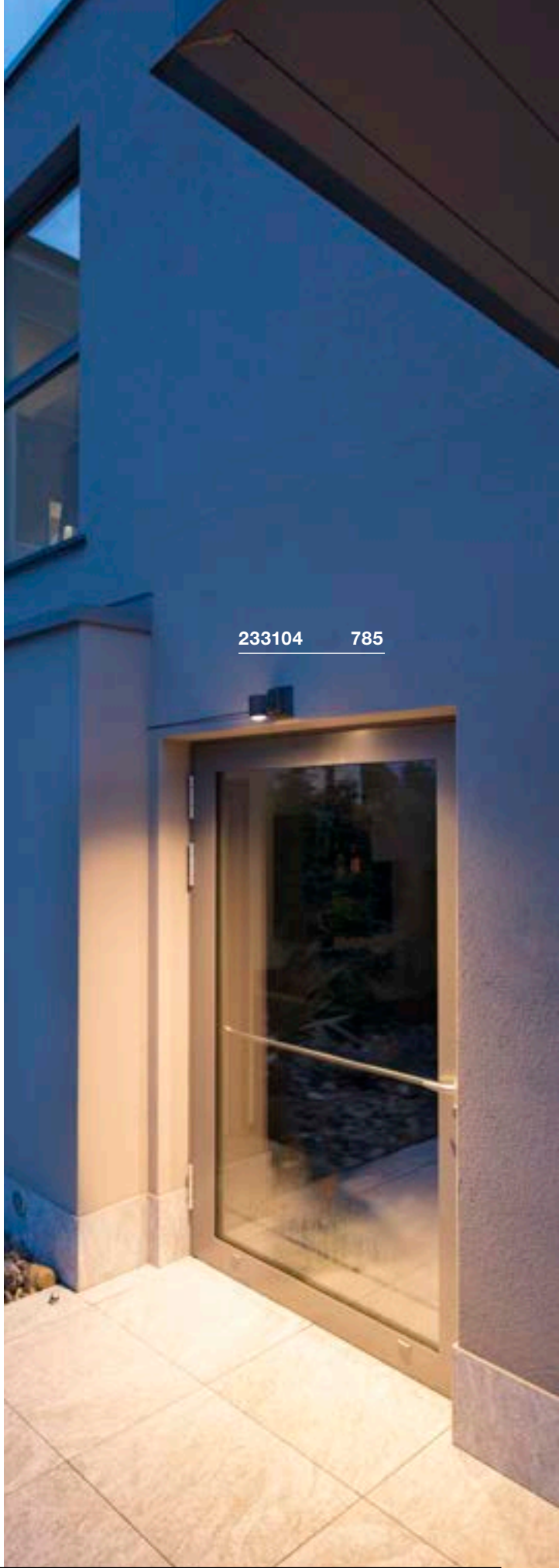
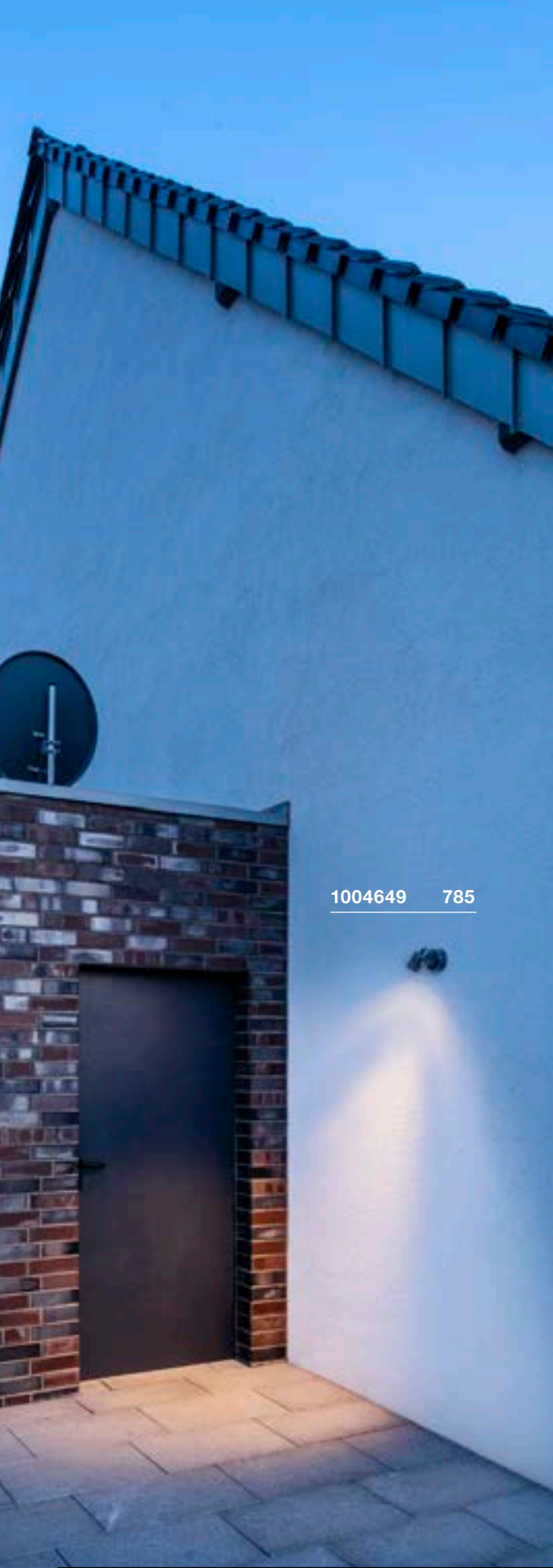



LED SPOT
SP

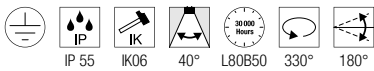
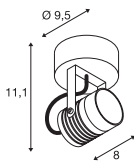

100-240V ~50/60Hz | 240mA
Total wattage: 6W
Material: aluminium/glass



Down 400lm | 3000K

Options	Prod. no.
● anthracite	1004649
● rust	1004957

NAUTILUS
WL QPAR51

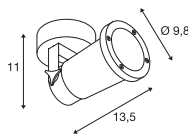

220-240V ~50/60Hz
Material: aluminium



Base: 1xGU10 Max. diameter: 5.1 cm L: 8.3 cm

Options	Prod. no.
● black	1002867



LED GU10 51mm | 6W | 38°
2700K | 450lm | EEK=F
6kWh/1000h

Prod. no.: 1005077



Product	Prod. no.
NAUTILUS Mounting plate	
● black	1002884

MYRA
CW, single, QPAR51

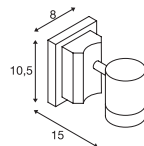

220-240V ~50/60Hz
Material: aluminium/glass



Base: 1xGU10 Max. diameter: 5.1 cm L: 5.7 cm

Options	Prod. no.
● anthracite	233105
● grey	233104



LED GU10 51mm | 6W | 38°
2700K | 450lm | EEK=F
6kWh/1000h

Prod. no.: 1005077



Product	Prod. no.
Surface-mounting frames	
● anthracite	233215
● grey	233214

1003427 793



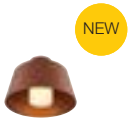

SCKET
PHOTONI | 789



LED
S-CUBE | 791



LED
ESKINA FRAME | 791



LED
ENOLA
OCULUS | 792



LED
ENOLA
ROUND S | 793



LED
ENOLA
ROUND M | 793



LED
ENOLA
ROUND L | 793



LED
ENOLA
SQUARE S | 795



LED
ENOLA
SQUARE M | 795



LED
ENOLA S
QUARE L | 795



LED
BIG THEO | 797



SCKET
BIG THEO | 797



LED
OVALISK | 797



SCKET
PHOTONIA | 799



SCKET
MOLAT | 799



SCKET
SITRA | 801



SCKET
ROX | 801



SCKET
ROX | 801

1007586 789

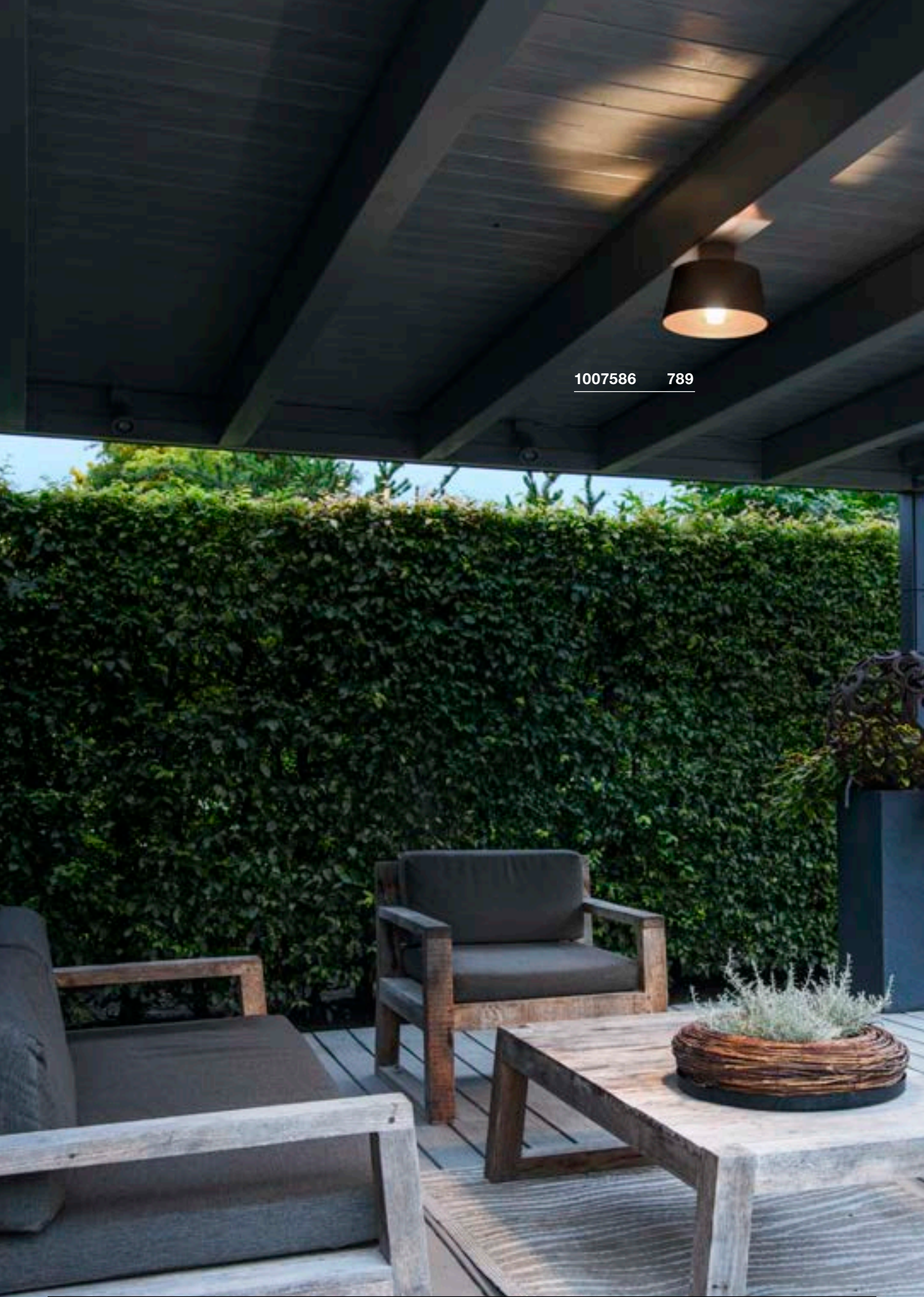



PHOTONI CL, E27

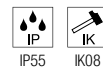
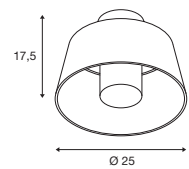

220-240V ~50/60Hz
Material: aluminium

- sea-air-resistant

SOCKET
INSIDE 13
W

Base: 1xE27 Max. diameter: 6 cm L: 11.6 cm

Options	Prod. no.
● black	1007586 ●
● rust	1007582 ●



LED E27 | 8W | 240°
3000K | 880lm | EEK=E
8kWh/1000h



Prod. no.: 1005289



1007461 791





S-CUBE CL

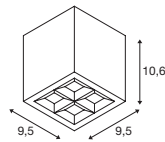

220-240V ~50/60Hz | 350mA
Total wattage: 15W
Material: aluminium



Down 1000lm | 2700K | 1200lm | 3000K

Options	Prod. no.
● anthracite	1007461 ●

ESKINA FRAME CL, single

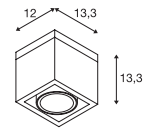

220-240V ~50/60Hz | 350mA
Total wattage: 15W
Material: aluminium/glass



Down 1100lm | 3000K | 1200lm | 4000K

Options	Prod. no.
● anthracite	1006316

ENOLA OCULUS CL

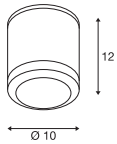

220-240V ~50/60Hz | 500mA
 Total wattage: 11W
 Material: aluminium/glass



Down 1000lm | 3000K | 1100lm | 4000K

Options	Prod. no.
● anthracite	1006327

Product	Prod. no.
Spacer	
● anthracite	1003479



1006327 792



ENOLA ROUND S CL

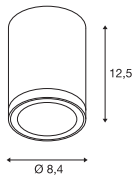

220-240V ~50/60Hz | 500mA
Total wattage: 9W
Material: aluminium/glass



Down 540lm | 3000K | 610lm | 4000K

Options	Prod. no.
● anthracite	1003426



Product	Prod. no.
Spacer	
● anthracite	1003479
Reflector 60°	
● chrome	1005262

ENOLA ROUND M CL

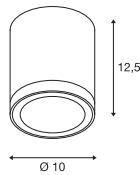

220-240V ~50/60Hz | 500mA
Total wattage: 11W
Material: aluminium/glass



Down 840lm | 3000K | 960lm | 4000K

Options	Prod. no.
● anthracite	1003427



Product	Prod. no.
Spacer	
● anthracite	1003479
Lens 19°	
● black	1005205
Asymmetrical lens	
● black/chrome	1005206
Reflector 60°	
● chrome	1005207

ENOLA ROUND L CL

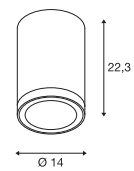

220-240V ~50/60Hz | 900mA
Total wattage: 36W
Material: aluminium/glass



Down 3200lm | 3000K | 3500lm | 4000K

Options	Prod. no.
● anthracite	1003442



Product	Prod. no.
Spacer	
● anthracite	1003479
Reflector 60°	
● chrome	1005263

1003421 795





ENOLA SQUARE S CL

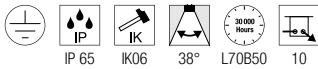
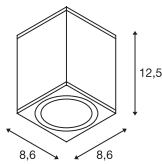

220-240V ~50/60Hz | 500mA
Total wattage: 9W
Material: aluminium/glass



Down 540lm | 3000K | 610lm | 4000K

Options	Prod. no.
● anthracite	1003420



Product	Prod. no.
Spacer	
● anthracite	1003479
Reflector 60°	
● chrome	1005207

ENOLA SQUARE M CL

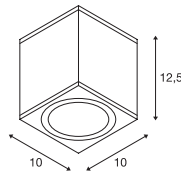

220-240V ~50/60Hz | 500mA
Total wattage: 11W
Material: aluminium/glass



Down 840lm | 3000K | 960lm | 4000K

Options	Prod. no.
● anthracite	1003421



Product	Prod. no.
Spacer	
● anthracite	1003479
Lens 19°	
● black	1005205
Asymmetrical lens	
● black/chrome	1005206
Reflector 60°	
● chrome	1005207

ENOLA SQUARE L CL

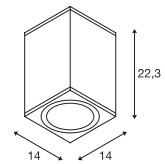

220-240V ~50/60Hz | 900mA
Total wattage: 36W
Material: aluminium/glass



Down 3200lm | 3000K | 3500lm | 4000K

Options	Prod. no.
● anthracite	1003439



Product	Prod. no.
Spacer	
● anthracite	1003479
Reflector 60°	
● chrome	1005263





BIG THEO
CL

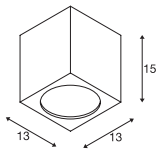

100-277V ~50/60Hz | 500mA
Total wattage: 21W
Material: aluminium/glass



Down 2000lm | 3000K

Options	Prod. no.
● anthracite	234535

BIG THEO
CL, QPAR111

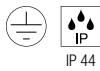
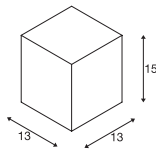

220-240V ~50/60Hz
Material: aluminium/glass



Base: 1xGU10

Options	Prod. no.
● anthracite	229555
○ white	229551
● grey	229554



QPAR111 | 12.5W | 10°
3000K | 950lm | EEK=F
13kWh/1000h

Prod. no.: 1005278



OVALISK
CL

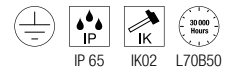
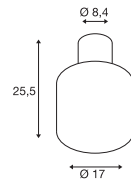

220-240V ~50/60Hz | 350mA
Total wattage: 7.9W
Material: aluminium/glass



Down 540lm | 3000K | 570lm | 4000K

Options	Prod. no.
● anthracite	1004677

232055 799

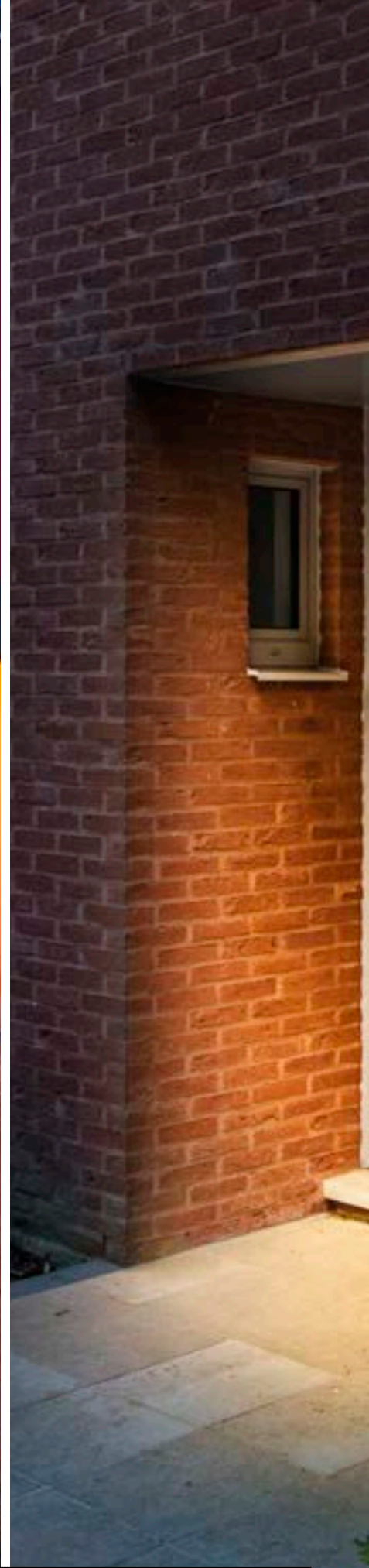



PHOTONIA
CL, E27

MOLAT
CL, E27

1000823 799

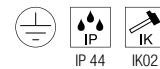
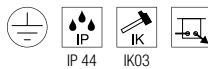
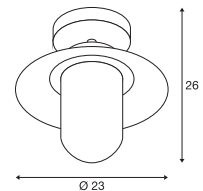
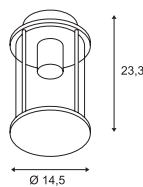

220-240V ~50/60Hz
Material: aluminium/glass

220-240V ~50/60Hz
Material: aluminium/glass



Base: 1xE27 Max. diameter: 9 cm L: 15 cm

Base: 1xE27 Max. diameter: 6.5 cm L: 14.5 cm

Options	Prod. no.
● anthracite	232055

Options	Prod. no.
● anthracite	1000823

 LED E27 | 7.5W | 320°
2500K | 700lm | EEK=F
8kWh/1000h
Prod. no.: 1005265



 LED E27 | 7.5W | 320°
2500K | 700lm | EEK=F
8kWh/1000h
Prod. no.: 1005265



Product	Prod. no.
Spacer	
● anthracite	1002853

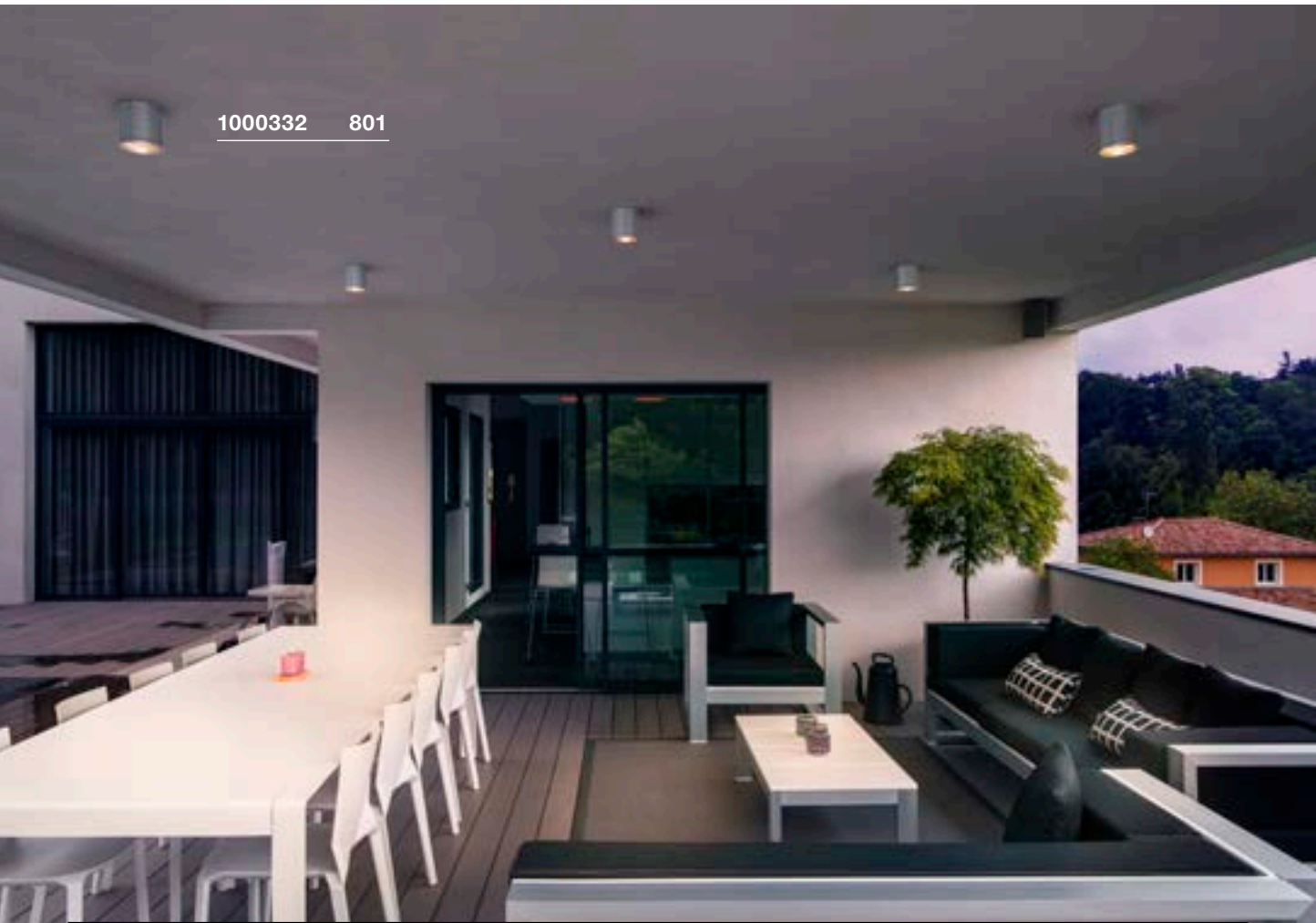



SITRA
CL, TCR-TSE

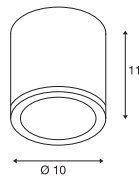

220-240V ~50/60Hz
Material: aluminium/glass



Base: 1xG53 Max. diameter: 7.5 cm L: 3.5 cm

Options	Prod. no.
<input checked="" type="radio"/> anthracite	231545
<input type="radio"/> white	231541



LED GX53 | 6.1W | 120°
3000K | 490lm | EEK=G
6kWh/1000h



Prod. no.: 1005271

ROX
CL, QPAR111

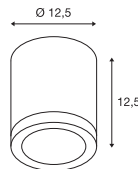

220-240V ~50/60Hz
Material: aluminium/glass



Base: 1xGU10

Options	Prod. no.
<input checked="" type="radio"/> aluminium	1000332



QPAR111 | 12.5W | 10°
3000K | 950lm | EEK=F
13kWh/1000h



Prod. no.: 1005278

ROX
CL, GX53

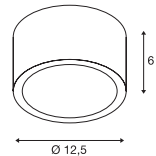

220-240V ~50/60Hz
Material: aluminium/glass



Base: 1xG53 Max. diameter: 7.5 cm L: 3.5 cm

Options	Prod. no.
<input checked="" type="radio"/> aluminium/trans-parent	1000339



LED GX53 | 6.1W | 120°
3000K | 490lm | EEK=G
6kWh/1000h



Prod. no.: 1005271

1005202 811





LED
R-CUBE | 805



LED
S-CUBE | 805



SOCKET
S-TUBE | 805



LED
ESKINA SPOT
SENSOR | 807



LED
ESKINA SPOT | 807



SOCKET
SITRA 360 | 808



SOCKET
THEO BRACKET | 808



LED
HELIA | 809



LED
HELIA | 809



SOCKET
MYRA | 811



LED
OUT-BEAM
FRAME | 811



LED
QUADRULO | 811



LED
AINOS | 812-813



LED
AINOS | 813



LED
AINOS | 813



LED
RUBA | 814



SOCKET
BULAN | 815



SOCKET
BULAN GRID | 815



LED
TERANG 200 | 817



LED
IMPERVA | 817



1007511 805

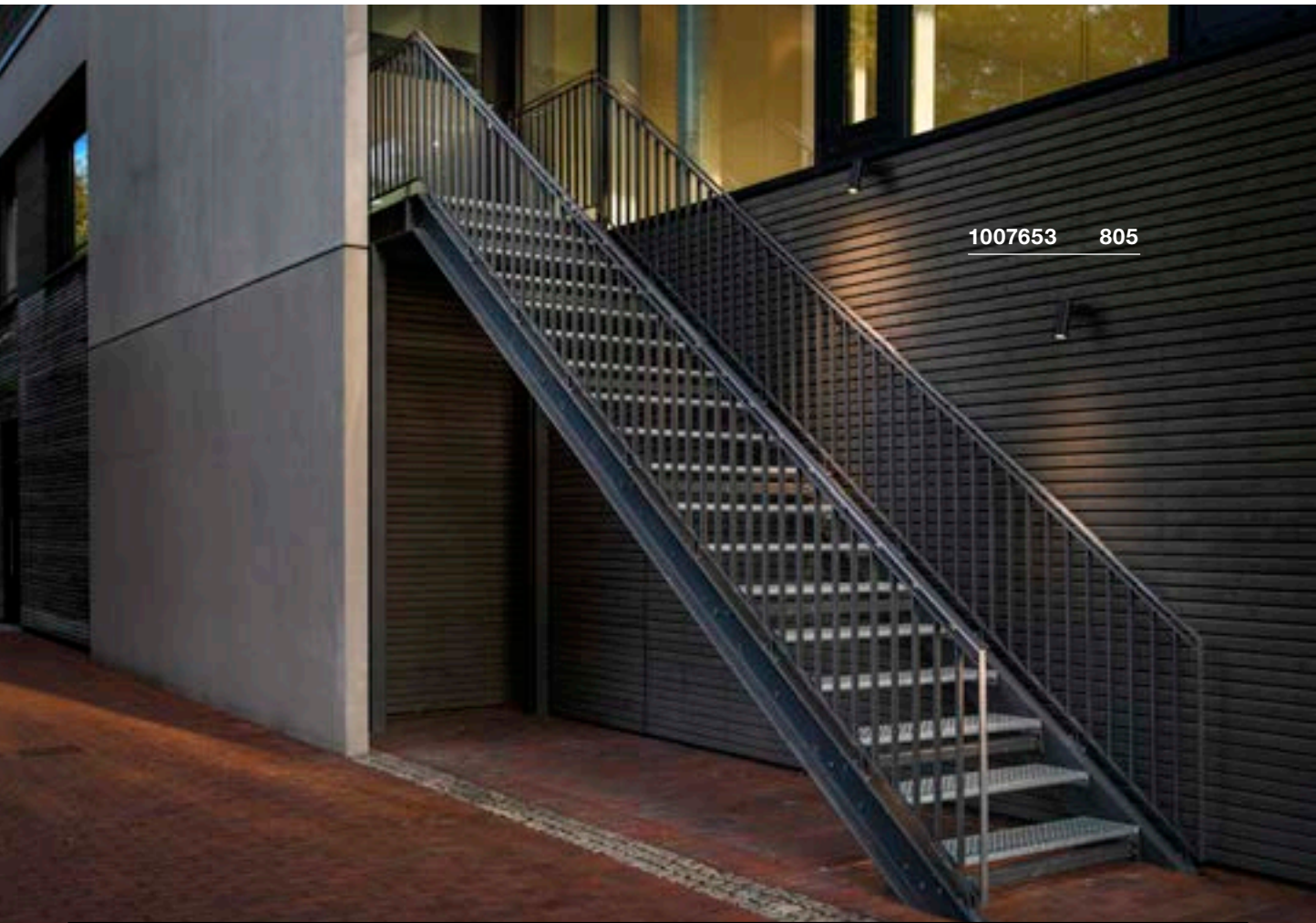

1007653 805



R-CUBE CW

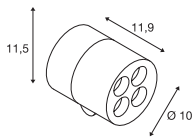

220-240V ~50/60Hz | 350mA
Total wattage: 15W
Material: aluminium



Down 800lm | 2700K | 800lm | 3000K

Options	Prod. no.
● anthracite	1007511 ●

S-CUBE CW

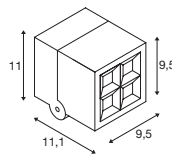

220-240V ~50/60Hz | 350mA
Total wattage: 15W
Material: aluminium



Down 1000lm | 2700K | 1200lm | 3000K

Options	Prod. no.
● anthracite	1007458 ●

S-TUBE CW

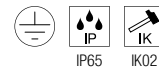
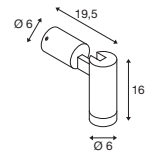

220-240V ~50/60Hz
Material: aluminium



Base: 1xGU10 Max. diameter: 5 cm | L: 5.5 cm

Options	Prod. no.
● black	1007653 ●



LED GU10 51mm | 6W | 38°
2700K | 450lm | EEK=F
6kWh/1000h



Prod. no.: 1005077

1002904 807

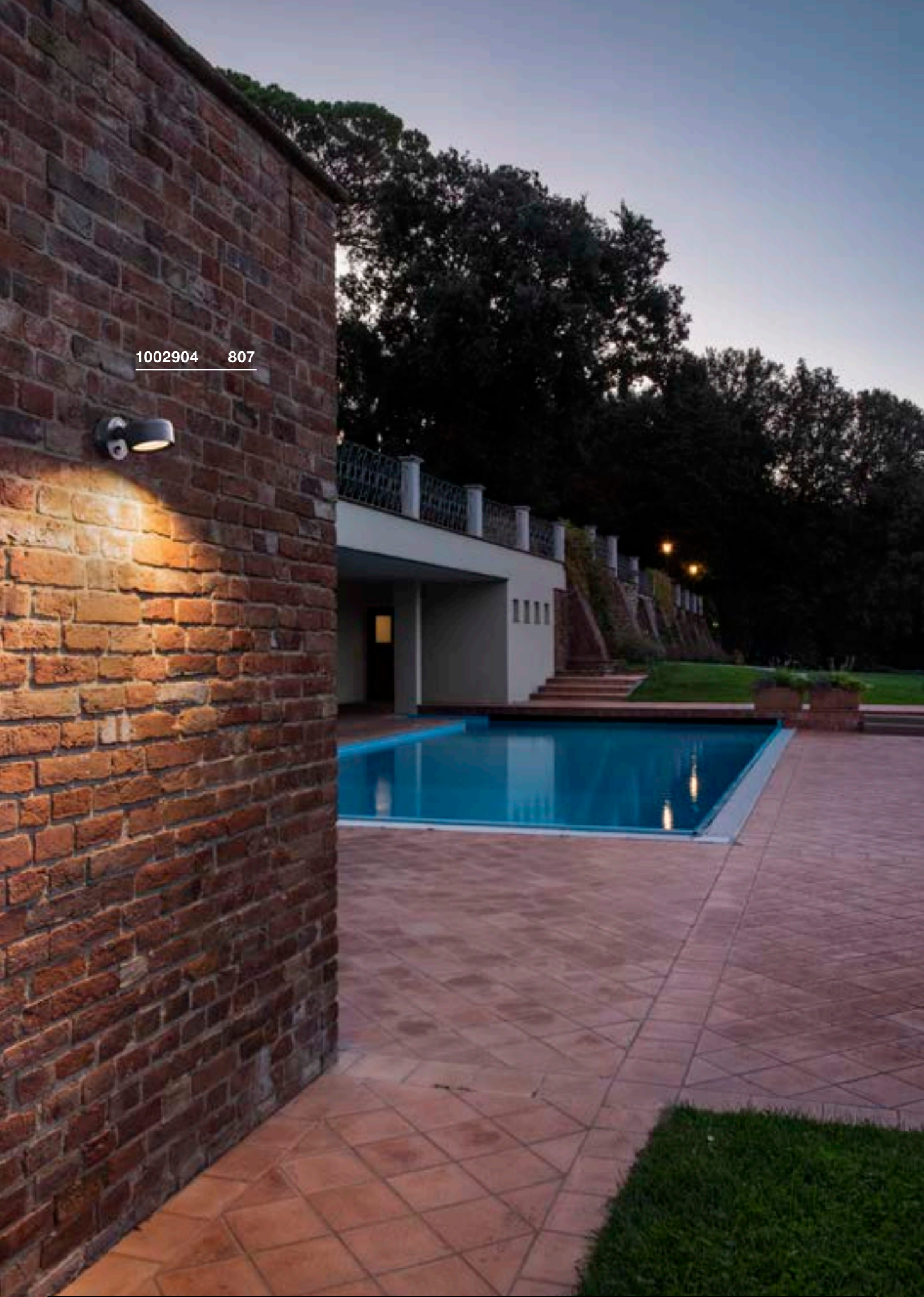



ESKINA SPOT SENSOR CW, PHASE

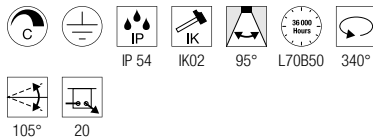
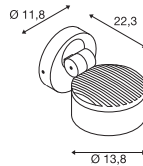

220-240V ~50/60Hz | 350mA
Total wattage: 15W
Material: aluminium

- Motion sensor in the wall rosette.



Down 1000lm | 3000K | 1000lm | 4000K

Options	Prod. no.
● anthracite	1002904

ESKINA SPOT CW, PHASE

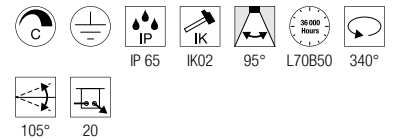
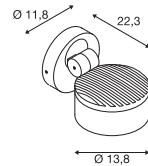

220-240V ~50/60Hz | 350mA
Total wattage: 14.5W
Material: aluminium



Down 1000lm | 3000K | 1000lm | 4000K

Options	Prod. no.
● anthracite	1002903

SITRA 360
CW, TCR-TSE

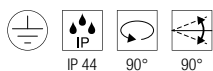
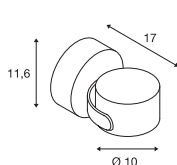

220-240V ~50/60Hz
Material: aluminium/glass



Base: 1xG53 Max. diameter: 7.5 cm L: 3.5 cm

Options

Prod. no.

- anthracite

231515



LED GX53 | 6.1W | 120°
3000K | 490lm | EEK=G
6kWh/1000h

Prod. no.: 1005271



THEO BRACKET
CW

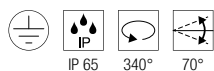
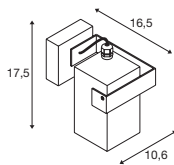

220-240V ~50/60Hz
Material: aluminium/glass



Base: 1xGU10 Max. diameter: 5.1 cm L: 5.7 cm

Options

Prod. no.

- anthracite

1004653



LED GU10 51mm | 6W | 38°
2700K | 450lm | EEK=F
6kWh/1000h

Prod. no.: 1005077



233245

809



1004653 808

HELIA
CW, single, PHASE

HELIA
CW, double, PHASE

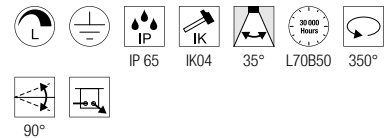
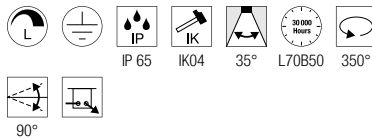
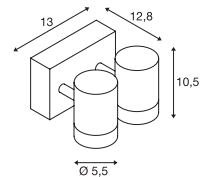
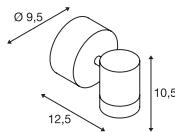

220-240V ~50/60Hz | 500mA
Total wattage: 6.5W
Material: aluminium/glass

220-240V ~50/60Hz | 500mA
Total wattage: 13W
Material: aluminium/glass



Down 440lm | 3000K

Down 880lm | 3000K

Options	Prod. no.
● anthracite	233245

Options	Prod. no.
● anthracite	233255

Product	Prod. no.
Spacer	
● anthracite	1002853

Product	Prod. no.
Spacer	
● anthracite	1002853

1003519 811



1005202 811

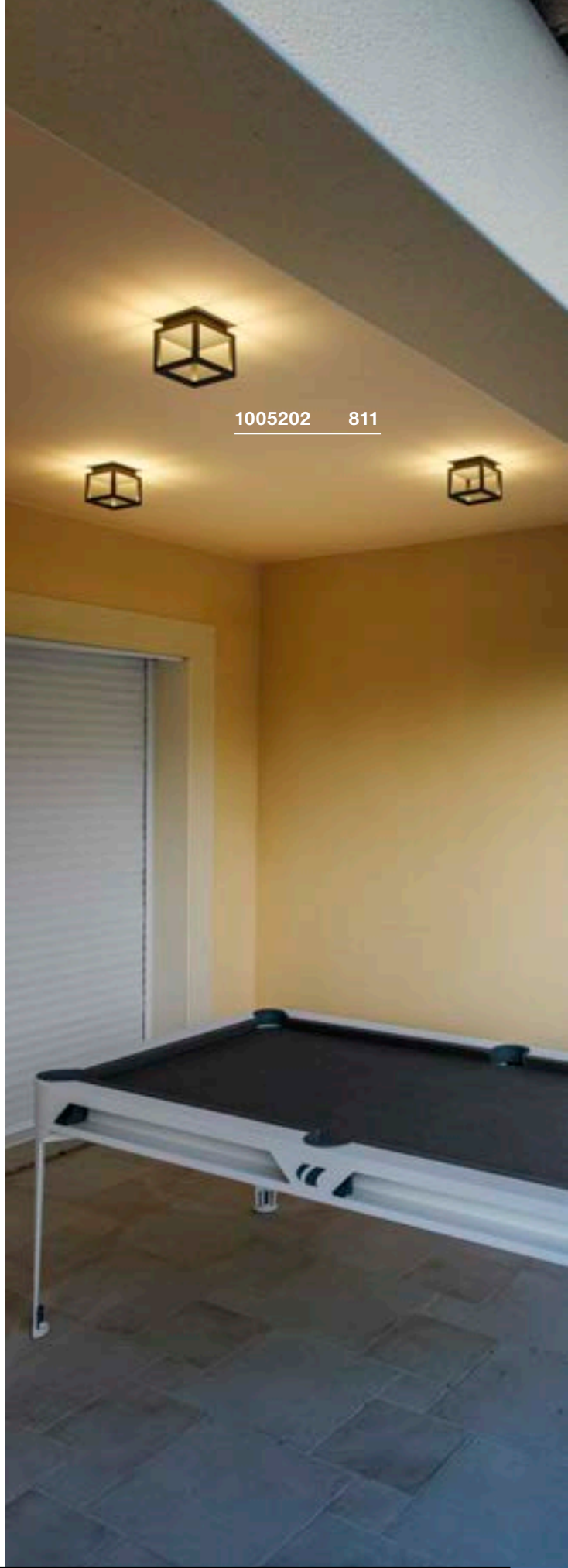



MYRA
WL, double, QPAR51

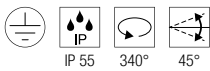
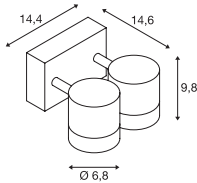

220-240V ~50/60Hz
Material: aluminium/glass



Base: 2xGU10 Max. diameter: 5.1 cm L: 5.7 cm

Options	Prod. no.
● anthracite	233095
● grey	233094



LED GU10 51mm | 6W | 38°
2700K | 450lm | EEK=F
6kWh/1000h



Prod. no.: **1005077**



Product	Prod. no.
Spacer	
● anthracite	1002853

OUT-BEAM FRAME
SP

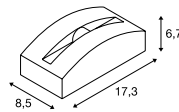

100-240V ~50/60Hz | 700mA
Total wattage: 3.5W
Material: aluminium/acrylic



Down 60lm | 3000K

Options	Prod. no.
● anthracite	1003518
○ white	1003519

QUADRULO
CL

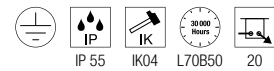
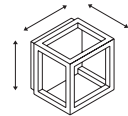

100-277V ~50/60Hz | 480mA
Total wattage: 7.5W
Material: aluminium/acrylic



Down 230lm | 3000K

Options	Prod. no.
● anthracite	1005202



229971 813

AINOS CW

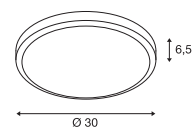

1003452 813

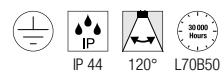

220-240V ~50/60Hz | 500mA
Total wattage: 21W
Material: aluminium/polycarbonate (PC)



Down

1430lm | 3000K

Options	Prod. no.
● anthracite	229965
○ white	229961



AINOS CW SENSOR

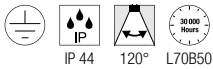
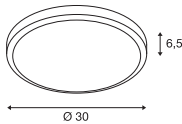

220-240V ~50/60Hz | 500mA
Total wattage: 22W
Material: aluminium/polycarbonate (PC)

- Sensor in the light housing.



Down 1430lm | 3000K

Options	Prod. no.
● anthracite	229975
○ white	229971

AINOS CW, square

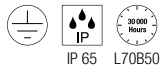
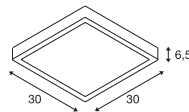

220-240V ~50/60Hz | 500mA
Total wattage: 17W
Material: aluminium/polycarbonate (PC)

AINOS CW SENSOR, square

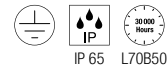
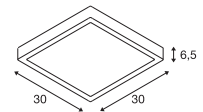

220-240V ~50/60Hz | 500mA
Total wattage: 18W
Material: aluminium/polycarbonate (PC)

- Sensor in the light housing.



Down 1300lm | 3000K | 1300lm | 4000K

Options	Prod. no.
● anthracite	1003450
○ white	1003449

Options	Prod. no.
● anthracite	1003452
○ white	1003451

RUBA CW

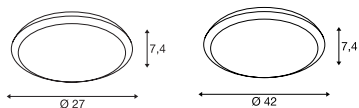

220-240V ~50/60Hz | 600mA
 Total wattage: 22W
 Material: polycarbonate (PC)



Down	960lm 2000lm	3000K	1100lm 2300lm	4000K
------	-----------------	-------	------------------	-------

Options	Prod. no.
○ white Ø: 27cm 960 / 1100lm 12W	1005089
○ white Ø: 42cm 2000 / 2300lm 22W	1005090

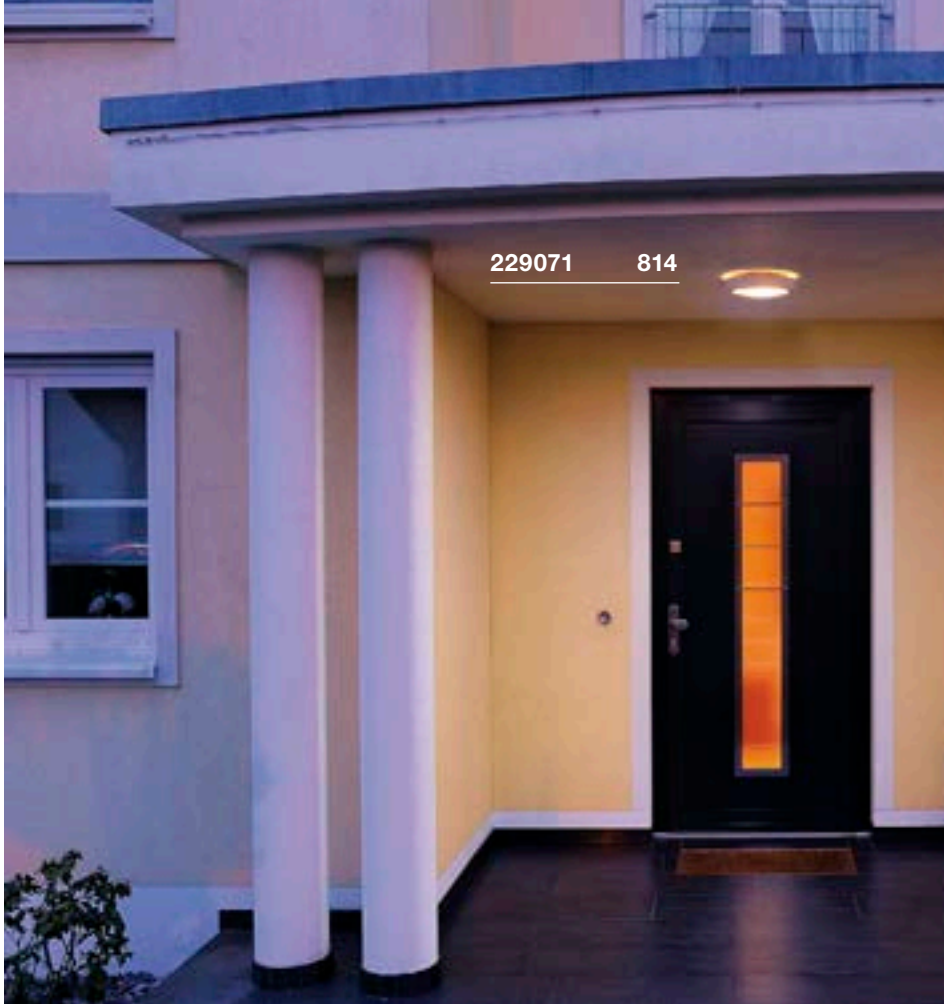



BULAN
CW, E14

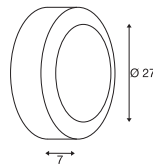

220-240V ~50/60Hz
Material: aluminium/glass



Base: 1xE14 Max. diameter: 4.8 cm L: 13 cm

Options	Prod. no.
● anthracite	229075
○ white	229071
● grey	229072



C35 | 4.2W | 320°
2700K | 350lm | EEK=G
5kWh/1000h

Prod. no.: 1005285



BULAN GRID
CW, E27

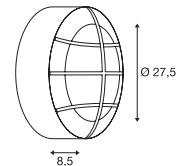

220-240V ~50/60Hz
Material: aluminium/polycarbonate (PC)



Base: 2xE27 Max. diameter: 5.2 cm L: 17.3 cm

Options	Prod. no.
● anthracite	229085
○ white	229081



| 13.5W | 240°
4000K | 1600lm | EEK=E
14kWh/1000h

Prod. no.: 1005308

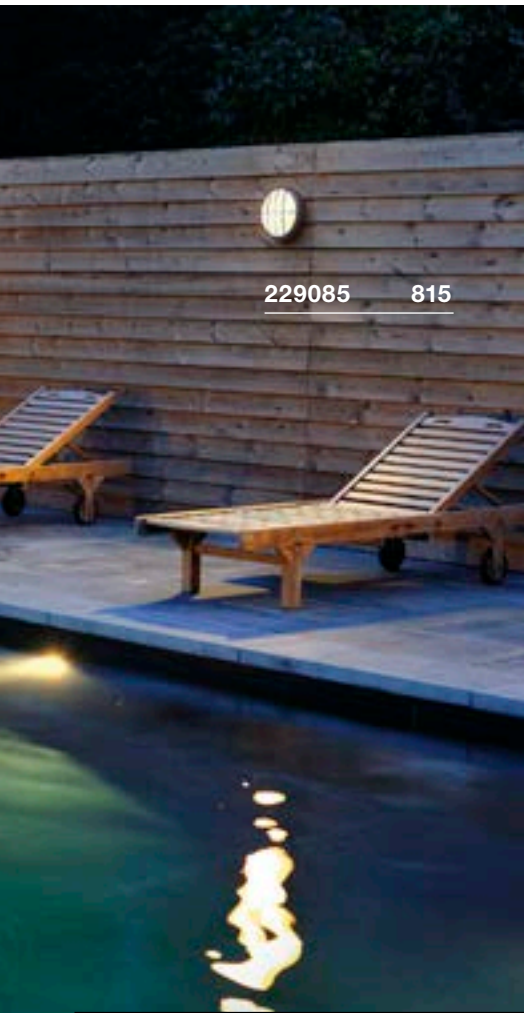

229085 **815**



229935 817



TERANG 200 CW

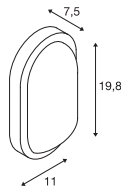

220-240V ~50/60Hz
Total wattage: 11W
Material: aluminium/polycarbonate (PC)



Down 830lm | 3000K

Options	Prod. no.
● anthracite	229935
○ white	229931

IMPERVA 120 CW

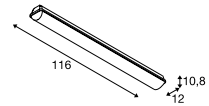

220-240V ~50/60Hz | 700mA
Total wattage: 40W
Material: polycarbonate (PC)



Down 4600lm | 3000K

Options	Prod. no.
● grey	1001314



233605 823



SCKET

CONCRETO | 821



LED

CONCRETO | 821



LED

ADI | 822



LED

DOWNUNDER
OUT S | 823



LED

DOWNUNDER
OUT M | 823



LED

DOWNUNDER
OUT L | 823



LED

BRICK MESH | 825



LED

BRICK | 825



LED

BRICK | 825



SCKET

BRICK
DOWNUNDER | 827



LED

BRICK
DOWNUNDER | 827



1006406 821

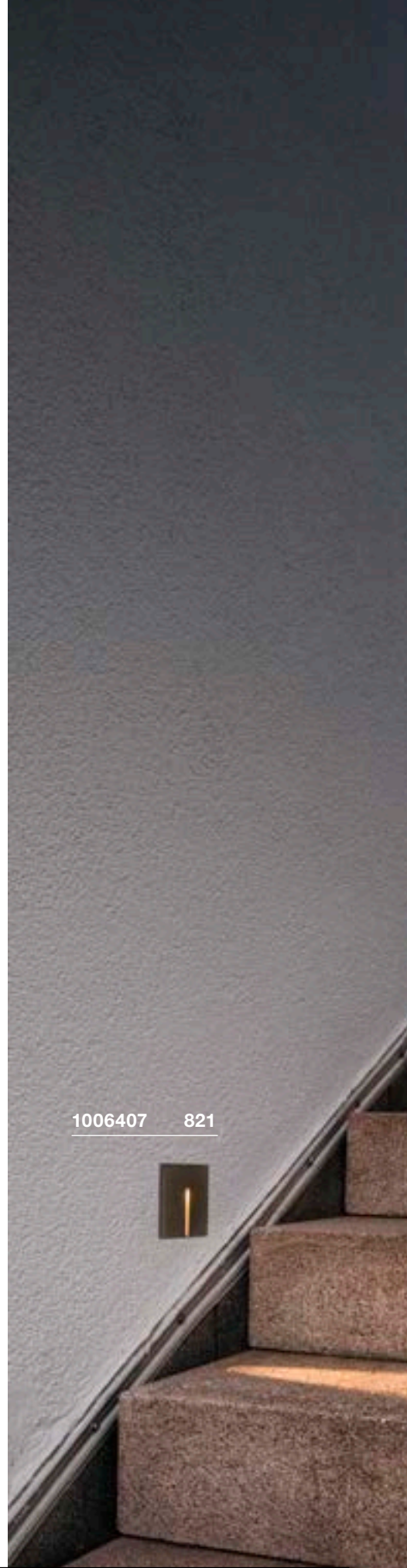

1006407 821



CONCRETO EL, Wing

CONCRETO EL, Cut

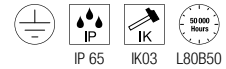
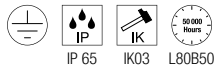
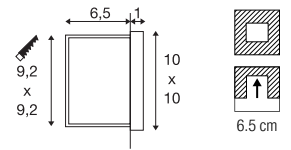
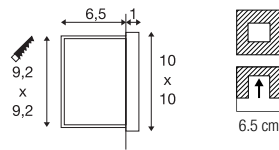

100-240V ~50/60Hz | 700mA
Total wattage: 3.2W
Material: concrete/aluminium

100-240V ~50/60Hz | 700mA
Total wattage: 3.2W
Material: concrete/aluminium

- Only mount the light with the light beam pointing downwards
- Recessed fixing kit included

- Only mount the light with the light beam pointing downwards
- Recessed fixing kit included



Down 45lm | 3000K

Down 15lm | 3000K

Options	Prod. no.
● grey	1006406 ●

Options	Prod. no.
● grey	1006407 ●

ADI
EL

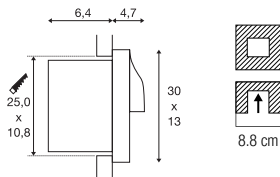

233625 823

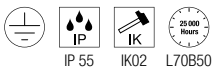

100-277V ~50/60Hz | 500mA
Total wattage: 18W
Material: aluminium/polycarbonate (PC)

- Only mount the light with the light beam pointing downwards
- Recessed fixing kit must be ordered separately



Down 940lm | 3000K

Options	Prod. no.
● anthracite	233635



Product	Prod. no.
Recessed fixing kit	
● black	233639

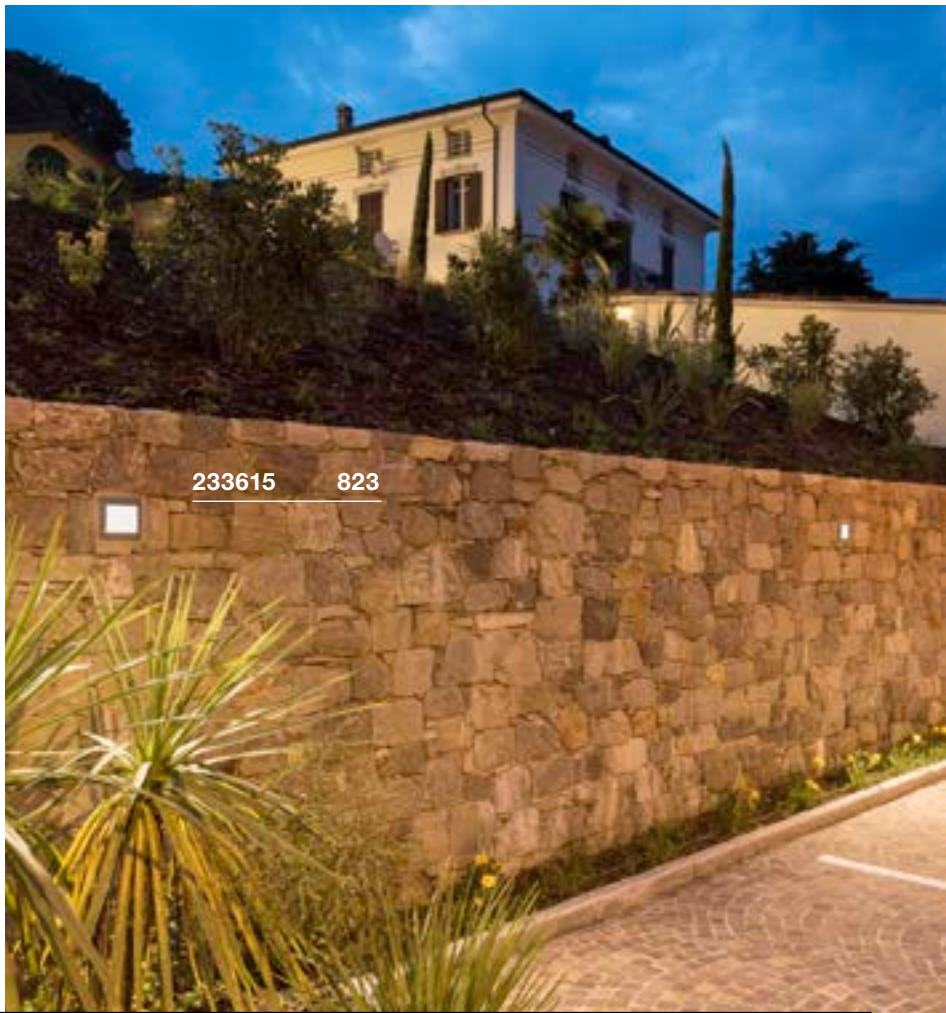

233615 823



DOWNUNDER OUT S EL

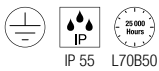
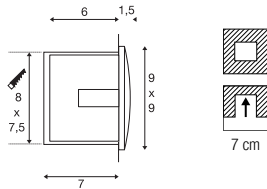

220-240V ~50/60Hz | 300mA
Total wattage: 1.7W
Material: aluminium/plastic

- Only mount the light with the light beam pointing downwards
- Recessed fixing kit included



Down 25lm | 3000K
65lm

Options	Prod. no.
● anthracite 25lm	233605
○ white 65lm	233601

DOWNUNDER OUT M EL

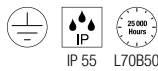
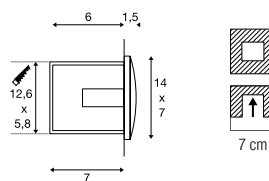

220-240V ~50/60Hz | 300mA
Total wattage: 4W
Material: aluminium/plastic

- Only mount the light with the light beam pointing downwards
- Recessed fixing kit included



Down 85lm | 3000K
155lm

Options	Prod. no.
● anthracite 85lm	233625
○ white 155lm	233621

DOWNUNDER OUT L EL

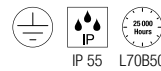
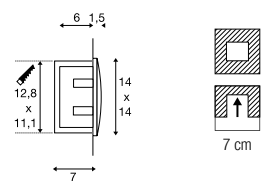

220-240V ~50/60Hz | 300mA
Total wattage: 4W
Material: aluminium/plastic

- Only mount the light with the light beam pointing downwards
- Recessed fixing kit included



Down 85lm | 3000K

Options	Prod. no.
● anthracite	233615



233650

825

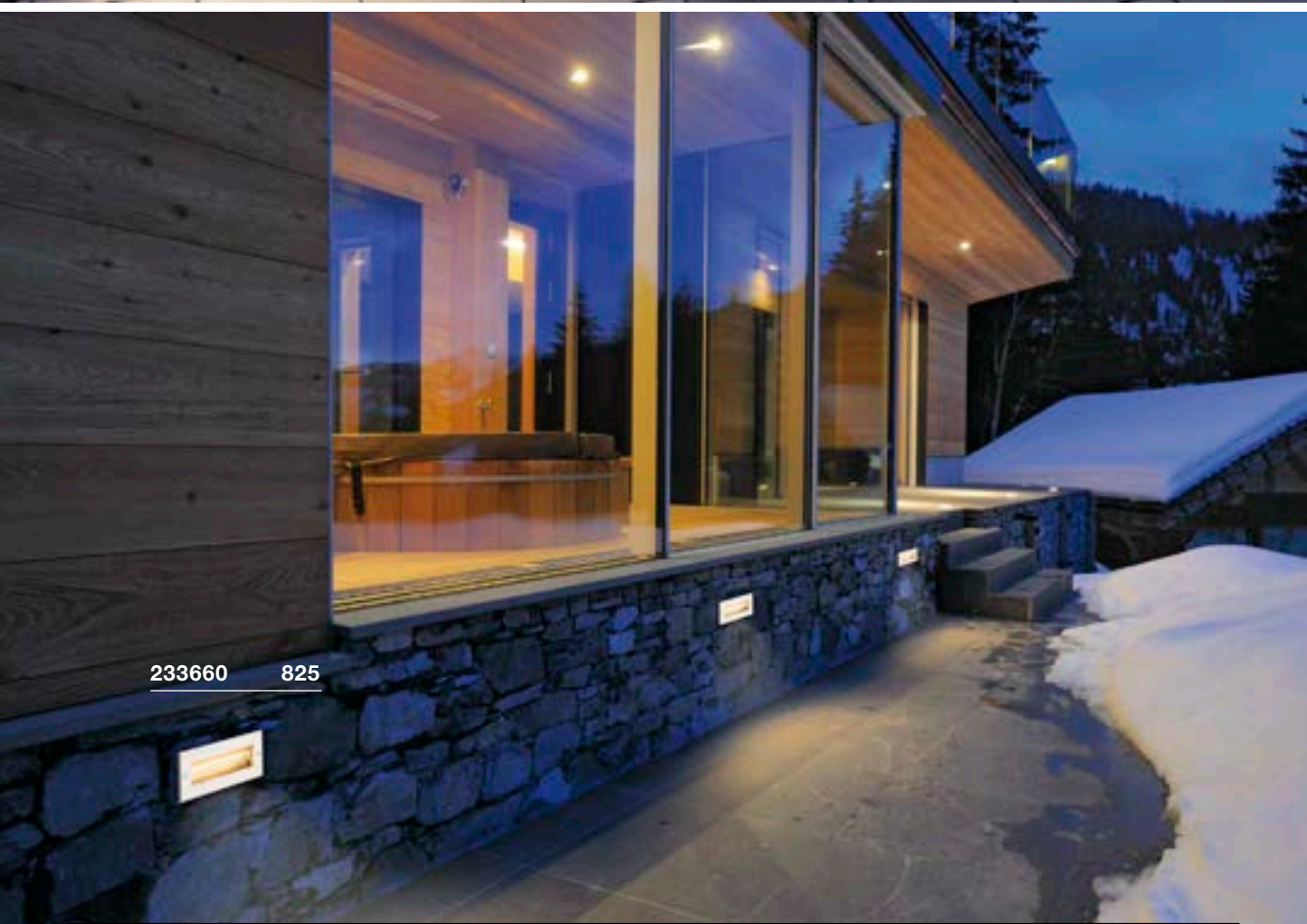

233660

825



BRICK MESH EL

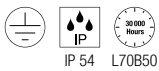
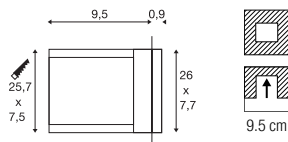
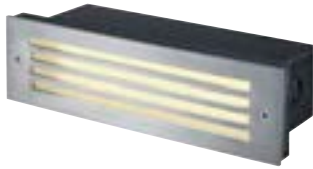

100-240V ~50/60Hz | 24V
Total wattage: 3.3W
Material: stainless steel 316/glass

- Recessed fixing kit included



Down 52lm | 3000K

Options	Prod. no.
● Stainless steel	229110

BRICK EL, symmetrical

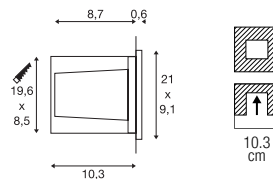

220-240V ~50/60Hz | 144mA
Total wattage: 9.5W
Material: aluminium/stainless steel 316

- Recessed fixing kit included



Down 950lm | 3000K

Options	Prod. no.
● Stainless steel	233650

BRICK EL, asymmetrical

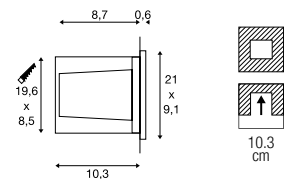

220-240V ~50/60Hz | 144mA
Total wattage: 9.5W
Material: aluminium/stainless steel 316

- Recessed fixing kit included



Down 850lm | 3000K

Options	Prod. no.
● Stainless steel	233660



229062 827



BRICK DOWNUNDER
EL, E14

BRICK DOWNUNDER
EL

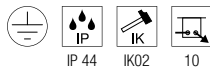
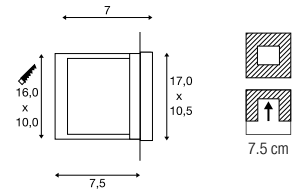
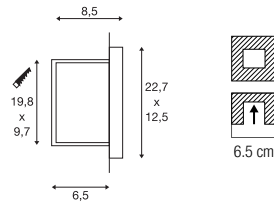

220-240V ~50/60Hz
Material: aluminium/glass

- No recessed fixing kit required

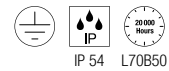

220-240V ~50/60Hz
Total wattage: 1.4W
Material: aluminium/glass

- Recessed fixing kit included



Base: 1xE14 Max. diameter: 4.3 cm | L: 12 cm



Down 30lm | 3000K

Options	Prod. no.
● grey	229062

Options	Prod. no.
● grey	229702



C35 | 4.2W | 320°
2700K | 350lm | EEK=G
5kWh/1000h



Prod. no.: 1005285



1006106 839



LED
DASAR® 600 | 831



LED
DASAR® 1200 | 831



LED
DASAR® S | 833



LED
DASAR® S | 833



LED
DASAR® L | 835



LED
DASAR® L | 835



LED
DASAR® XL | 837



LED
DASAR® XL | 837



LED
DASAR®
FLAT 80 | 839



LED
DASAR®
FLAT 120 | 839



LED
DASAR® 255 | 839



LED
DASAR® 920 | 840



LED
DASAR® 920 | 840



LED
DASAR® 270 | 841



LED
DASAR® 270 | 841



SOCKET
DASAR® 115 | 843



SOCKET
DASAR® 115 | 843



SOCKET
DASAR® 115 | 843



SOCKET
DASAR®
EXACT 116 | 845



SOCKET
DASAR®
EXACT 116 | 845



SOCKET
DASAR® 215 | 846



SOCKET
DASAR® 215 | 846



SOCKET
DASAR® 215 | 847



LED
DASAR® 215 | 847



LED
TRAIL-LITE® 60 | 848



LED
POWER
TRAIL-LITE® | 849



LED
POWER
TRAIL-LITE® | 849



LED
GIMBLE OUT | 849



LED
SMALL PLOT | 851



LED
SMALL PLOT | 851



SMALL PLOT | 851



SMALL PLOT | 851



LED
BIG PLOT | 853



LED
BIG PLOT | 853



BIG PLOT | 853



BIG PLOT | 853



LED
ROCCI | 854



LED
ROCCI | 854



LED
ROCCI 200 | 855



LED
ROCCI 200 | 855



SOCKET
SOLASTO | 857



SOCKET
SOLASTO | 857



1007196 831



DASAR® 600 EL

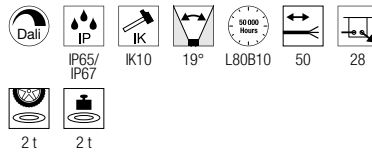
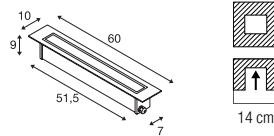

220-240V ~50/60Hz | 550mA
Total wattage: 18W
Material: stainless steel 316

- with connector



Up 2200lm | 3000K

Options	Prod. no.
● Stainless steel	1007195 ●



Product	Prod. no.
Recessed fixing kit	
● black	1007198

DASAR® 1200 EL

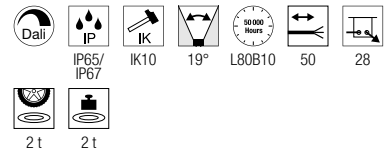
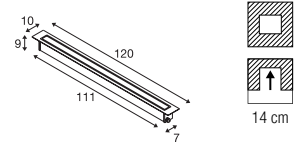

220-240V ~50/60Hz | 900mA
Total wattage: 34W
Material: stainless steel 316

- with connector



Up 4100lm | 3000K

Options	Prod. no.
● Stainless steel	1007196 ●



Product	Prod. no.
Recessed fixing kit	
● black	1007197



1007680 833



DASAR® S RL, round

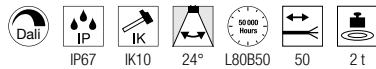
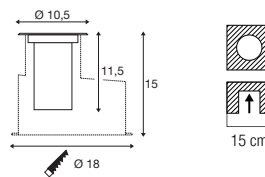

220-240V ~50/60Hz | 200mA
Total wattage: 4W
Material: aluminium

- IP connection box



Up 350lm | 3000K

Options	Prod. no.
● anthracite	1007680 ●



Product	Prod. no.
Floor-recessed fixing kit S	
● black	1007682
Reflector 15°	
● silver	1007683
Reflector 36°	
● silver	1007684
Reflector 50°	
● silver	1007685

DASAR® S RL, square

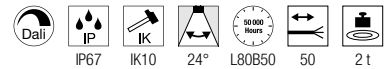
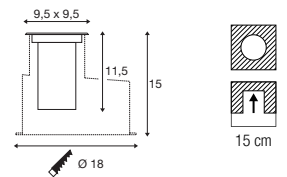

220-240V ~50/60Hz | 200mA
Total wattage: 4W
Material: aluminium

- IP connection box



Up 350lm | 3000K

Options	Prod. no.
● anthracite	1007681 ●



Product	Prod. no.
Floor-recessed fixing kit S	
● black	1007682
Reflector 15°	
● silver	1007683
Reflector 36°	
● silver	1007684
Reflector 50°	
● silver	1007685



1007243 835



DASAR® L RL, round

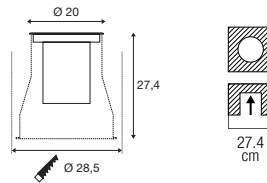

220-240V ~50/60Hz | 500mA
Total wattage: 19 W
Material: aluminium

- with Y connector



Up 1950lm | 3000K

Options	Prod. no.
● Stainless steel	1007243 ●



Product	Prod. no.
Recessed fixing kit for DASAR L	
● black	1007245
Reflector 15° for L / XL	
● silver	1007238
Reflector 36° for L / XL	
● silver	1007239
Reflector 60° for L / XL	
● silver	1007240

DASAR® L RL, square

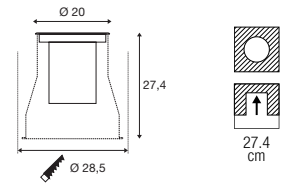

220-240V ~50/60Hz | 500mA
Total wattage: 19 W
Material: aluminium

- with Y connector



Up 1950lm | 3000K

Options	Prod. no.
● black	1007244 ●



Product	Prod. no.
Recessed fixing kit for DASAR L	
● black	1007245
Reflector 15° for L / XL	
● silver	1007238
Reflector 36° for L / XL	
● silver	1007239
Reflector 60° for L / XL	
● silver	1007240



1007242 837



DASAR® XL RL, round

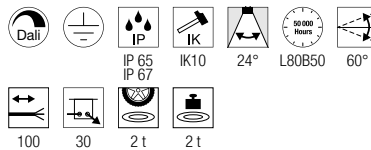
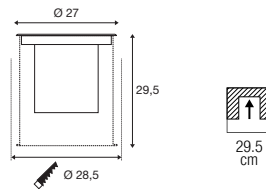

220-240V ~50/60Hz | 700mA
Total wattage: 27W
Material: aluminium

- with Y connector



Up 2790lm | 3000K

Options	Prod. no.
● Stainless steel	1007241 ●



Product	Prod. no.
Recessed fixing kit for DASAR XL	
● black	1007246
○ Reflector 15° for L / XL	
○ silver	1007238
○ Reflector 36° for L / XL	
○ silver	1007239
○ Reflector 60° for L / XL	
○ silver	1007240

DASAR® XL RL, square

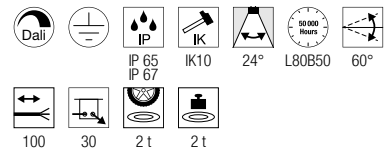
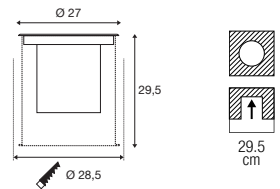

220-240V ~50/60Hz | 700mA
Total wattage: 27W
Material: aluminium

- with Y connector



Up 2790lm | 3000K

Options	Prod. no.
● Stainless steel	1007242 ●



Product	Prod. no.
Recessed fixing kit for DASAR XL	
● black	1007246
○ Reflector 15° for L / XL	
○ silver	1007238
○ Reflector 36° for L / XL	
○ silver	1007239
○ Reflector 60° for L / XL	
○ silver	1007240



228412 839



229383 839



DASAR® FLAT 80
EL

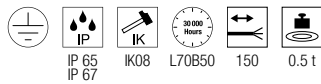
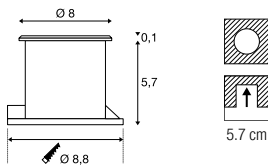

220-240V ~50/60Hz
Total wattage: 3.5W
Material: stainless steel 304/glass

- Both IP protection classes have been met.
- This light is suitable for installation in wood.
- Open cable end



Up 140lm | 3000K

Options	Prod. no.
● Stainless steel	228412



Product	Prod. no.
---------	-----------

Connection box IP68, 3-pole
● black **228730**

DASAR® FLAT 120
EL

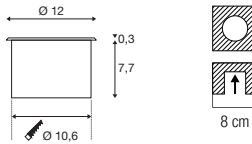

220-240V ~50/60Hz | 350mA
Total wattage: 7W
Material: stainless steel 304/aluminium

- Open cable end



Up 490lm | 3000K
540lm | 4000K

Options	Prod. no.
● Stainless steel 490lm 3000K	1006106
● Stainless steel 540lm 4000K	1006107

DASAR® 255
EL

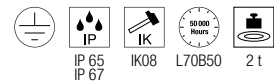
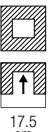
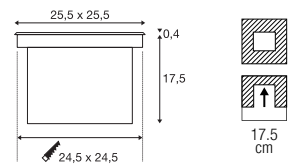

220-240V ~50/60Hz | 750mA
Total wattage: 31W
Material: stainless steel 316/glass

- Both IP protection classes have been met.



Up 1660lm | 3000K
1720lm | 4000K

Options	Prod. no.
● Stainless steel 1660lm 3000K	229383
● Stainless steel 1720lm 4000K	229381

DASAR® 920
EL

DASAR® 920
EL

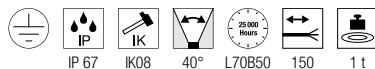
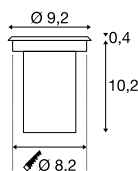
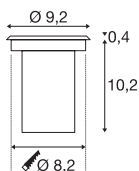

12-24V
Total wattage: 6.5W
Material: stainless steel 316/glass

- Open cable end



Up 520lm | 3000K

Options	Prod. no.
● Stainless steel	233500



Product	Prod. no.
LED power supply 15W 12V	
○ white	1005444
LED power supply 15 W 24V	
○ white	1005445

220-240V ~50/60Hz | 400mA
Total wattage: 5.5W
Material: stainless steel 316/glass

- Open cable end



Up 300lm | 3000K

Options	Prod. no.
● Stainless steel	233520





DASAR® 270
EL, asymmetrical

DASAR® 270
EL, symmetrical

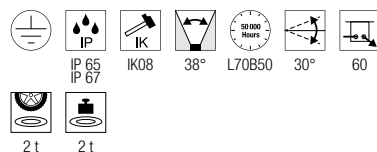
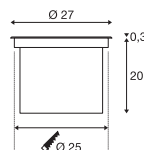
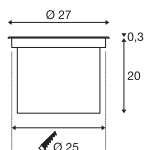

220-240V ~50/60Hz | 700mA
Total wattage: 30W
Material: stainless steel 316/glass

220-240V ~50/60Hz | 700mA
Total wattage: 30W
Material: stainless steel 316/glass



Up 2000lm | 3000K
2100lm | 4000K

Up 2500lm | 3000K
2600lm | 4000K

Options	Prod. no.
● stainless steel 2000lm 3000K	1002893
● stainless steel 2100lm 4000K	1002895

Options	Prod. no.
● stainless steel 2500lm 3000K	1002897
● stainless steel 2600lm 4000K	1002898



Product	Prod. no.
DASAR® 270 Honeycomb cover	
● black	1002899





229320 843



DASAR® 115
RL, square, QPAR51

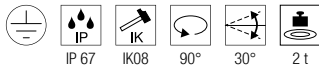
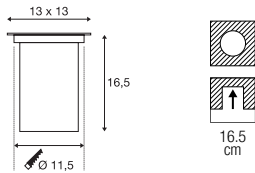

220-240V ~50/60Hz
Material: stainless steel 316/glass

SOCKET INSIDE <35 W

Base: 1xGU10 Max. diameter: 5.1 cm L: 6 cm

Options	Prod. no.
● Stainless steel	229324



LED GU10 51mm | 6W | 38°
2700K | 450lm | EEK=F
6kWh/1000h

Prod. no.: 1005075



DASAR® 115
RL, round, QPAR51

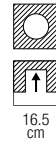
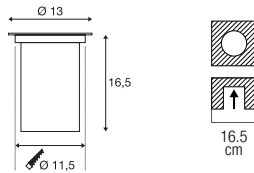

220-240V ~50/60Hz
Material: stainless steel 316/glass

SOCKET INSIDE <35 W

Base: 1xGU10 Max. diameter: 5.1 cm L: 6 cm

Options	Prod. no.
● Stainless steel	229320



LED GU10 51mm | 6W | 38°
2700K | 450lm | EEK=F
6kWh/1000h

Prod. no.: 1005075



DASAR® 115
RL, square, QPAR51

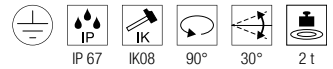
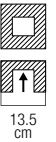
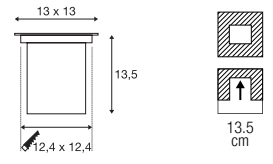

220-240V ~50/60Hz
Material: stainless steel 316/glass

SOCKET INSIDE <35 W

Base: 1xGU10 Max. diameter: 5.1 cm L: 6 cm

Options	Prod. no.
● Stainless steel	229374



LED GU10 51mm | 6W | 38°
2700K | 450lm | EEK=F
6kWh/1000h

Prod. no.: 1005075





228430 845



DASAR® EXACT 116
EL, square, QPAR51

DASAR® EXACT 116
EL, round, QPAR51

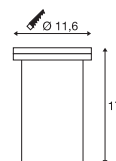
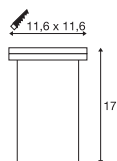

220-240V ~50/60Hz
Material: stainless steel 316/glass

220-240V ~50/60Hz
Material: stainless steel 316/glass



Base: 1xGU10 Max. diameter: 5.1 cm L: 6 cm

Base: 1xGU10 Max. diameter: 5.1 cm L: 6 cm

Options	Prod. no.
● Stainless steel	228434

Options	Prod. no.
● Stainless steel	228430



LED GU10 51mm | 6W | 38°
2700K | 450lm | EEK=F
6kWh/1000h



Prod. no.: 1005077



LED GU10 51mm | 6W | 38°
2700K | 450lm | EEK=F
6kWh/1000h



Prod. no.: 1005077

DASAR® 215
RL, round, QPAR111

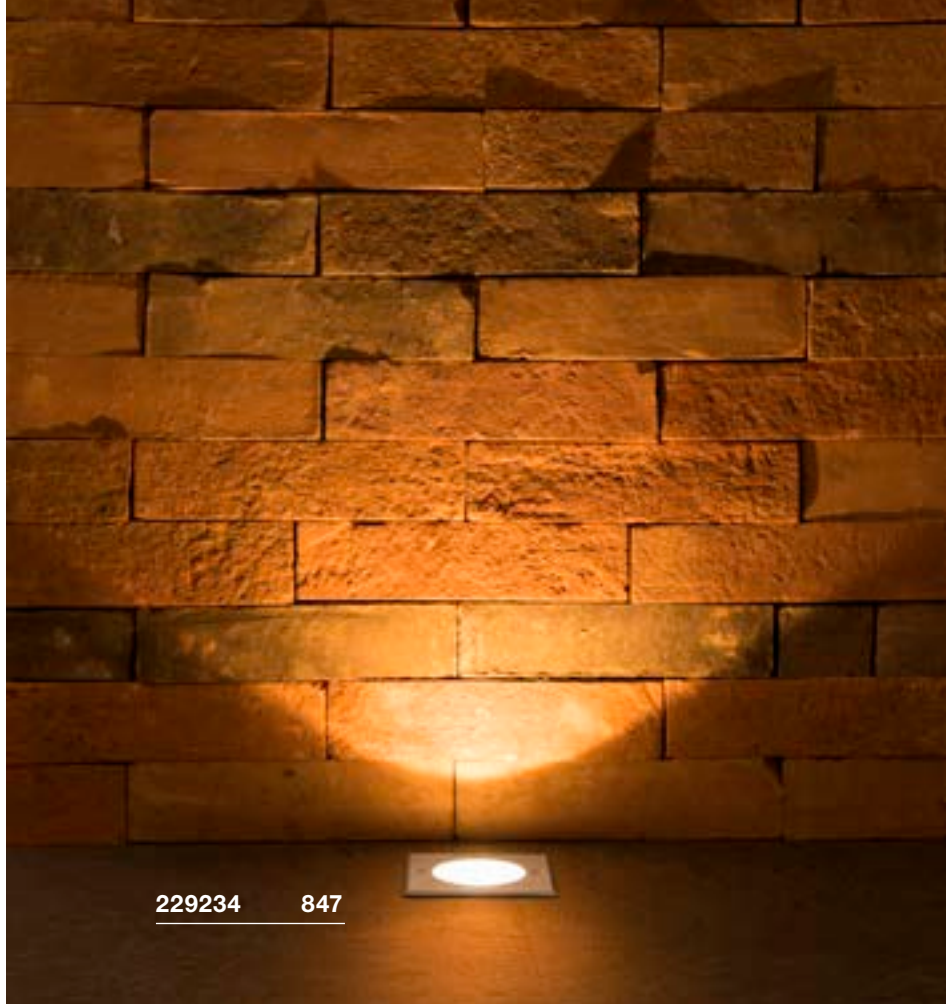
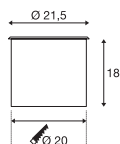

220-240V ~50/60Hz
Material: stainless steel 316/glass

SOCKET INSIDE <75 W

Base: 1xGU10

Options	Prod. no.
● Stainless steel	229230



QPAR111 | 12.5W | 10°
3000K | 950lm | EEK=F
13kWh/1000h



Prod. no.: 1005278





DASAR® 215
RL, square, QPAR111

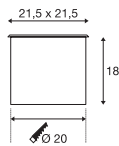

220-240V ~50/60Hz
Material: stainless steel 316/glass



Base: 1xGU10

Options	Prod. no.
● Stainless steel	229234



QPAR111 | 12.5W | 10°
3000K | 950lm | EEK=F
13kWh/1000h

Prod. no.: 1005278



DASAR® 215
RL, round, E27

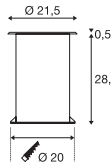

220-240V ~50/60Hz
Material: stainless steel 316/glass



Base: 1xE27 Max. diameter: 4.5 cm L: 13.4 cm

Options	Prod. no.
● Stainless steel	229200



LED E27 | 8W | 240°
3000K | 880lm | EEK=E
8kWh/1000h

Prod. no.: 1005289



DASAR® 370
EL, round

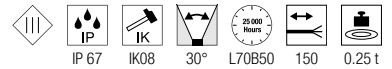
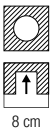
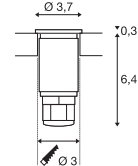

12-24V
Power consumption: 2W
Material: stainless steel 316/glass

- This light is suitable for installation in wood
- Open cable end



Up 120lm | 3000K

Options	Prod. no.
● Stainless steel	233540



Product Prod. no.
LED power supply 15W | 12V
○ white 1005444
LED power supply 15W | 24V
○ white 1005445

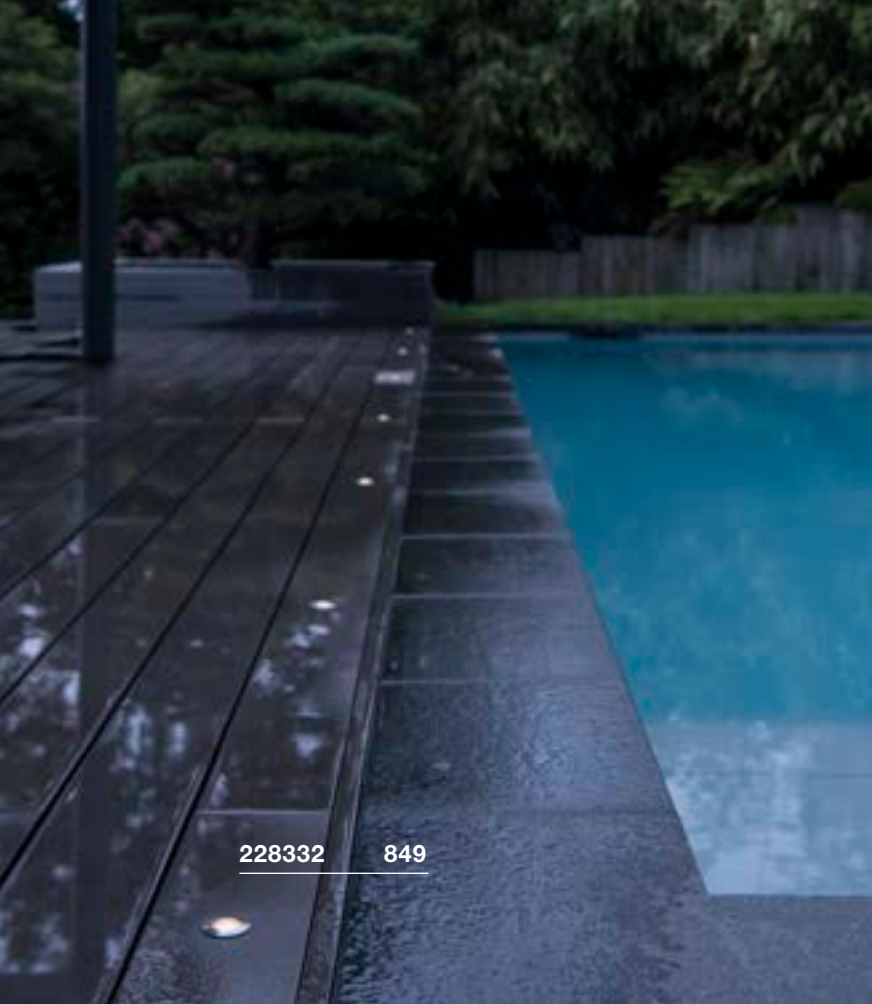

228332 849

TRAIL-LITE® 60 EL

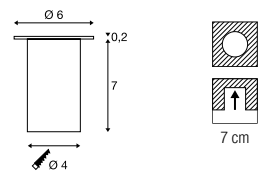

1000384 849



12V ~50/60Hz
Power consumption: 0.3W
Material: stainless steel 316/glass

- Only operate with conventional transformer.
- Recessed fixing kit included
- This light is suitable for installation in wood



Up

10lm | 3000K

Options	Prod. no.
● Stainless steel	227462



POWER TRAIL-LITE®
EL, square

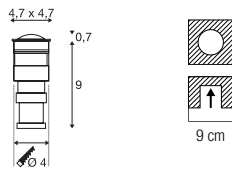

350mA
Total wattage: 1W
Material: stainless steel 316/glass

- Operate only with 350mA driver. Only wire together multiple power LEDs in series! Installation sleeve included. The light is suitable for installation in wood
- Open cable end



Up 45lm | 3000K

Options	Prod. no.
● Stainless steel	228342



Product	Prod. no.
LED driver 3W 350W	
○ white	1005248 ●

POWER TRAIL-LITE®
EL, round

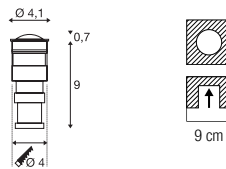

350mA
Total wattage: 1W
Material: stainless steel 316/glass

- Operate only with 350mA driver. Only wire together multiple power LEDs in series!
- This light is suitable for installation in wood
- Open cable end



Up 45lm | 3000K

Options	Prod. no.
● Stainless steel	228332

GIMBLE OUT
EL

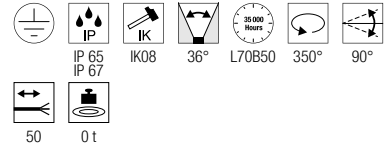
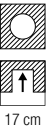
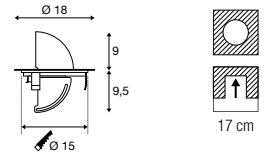

220-240V ~50/60Hz | 600mA
Total wattage: 13W
Material: stainless steel 316

- Open cable end



Up 1100lm | 3000K

Options	Prod. no.
● Stainless steel	1000384



Product	Prod. no.
Floor-recessed fixing kit	
● black	1000655
Installation pipe DN160	
● grey	233792
Connection box IP68, 3-pole	
● black	228730



1006171 + 1006173 851



SMALL PLOT Modules



SMALL PLOT Modules



SMALL PLOT Cover, 2-pack



H: 1.7 cm
 Diameter: 10.3 cm
 Material 1006173: Stainless steel
 Material 1006174: Aluminium

- 500 kg load for 1006174
- 800 kg load for 1006173

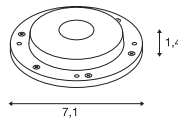
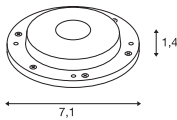

24V DC
 Power consumption: 2.6W
 Material: aluminium/polymethylacrylate (PMMA)

- This product is delivered without a cover.
- Open cable end

24V DC
 Power consumption: 2.6W
 Material: stainless steel/polymethylacrylate (PMMA)

- This product is delivered without a cover.
- Open cable end



Up 240lm | 3000K

Options	Prod. no.
● aluminium	1006172



Up 240lm | 3000K

Options	Prod. no.
● Stainless steel	1006171



H: 1.7 cm
 Diameter: 10.3 cm
 Material 1006175: Stainless steel
 Material 1006176: Aluminium



Product	Prod. no.
LED power supply, 12/20W 24V inc. strain relief	
○ white	1005381
LED power supply 15 W 24V	
○ white	1005445



Product	Prod. no.
LED power supply, 12/20W 24V inc. strain relief	
○ white	1005381
LED power supply 15 W 24V	
○ white	1005445

Options	Prod. no.
● anthracite	1006176
● Stainless steel	1006175



1001359 + 1001255 853



BIG PLOT Modules



BIG PLOT Modules

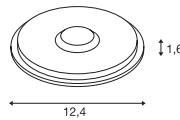
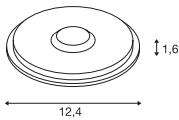

220-240V ~50/60Hz
 Total wattage: 5.5W
 Material: aluminium/polymethylacrylate (PMMA)

- This product is delivered without a cover
- Open cable end



Up 500lm | 3000K

Options	Prod. no.
● aluminium	1001256

Product	Prod. no.
T-connector box	
● black	228726
Connection box IP68, 3-pole	
● black	228730



220-240V ~50/60Hz
 Total wattage: 5.5W
 Material: stainless steel/polymethylacrylate (PMMA)

- This product is delivered without a cover
- Open cable end



Up 500lm | 3000K

Options	Prod. no.
● Stainless steel	1001359

Product	Prod. no.
T-connector box	
● black	228726
Connection box IP68, 3-pole	
● black	228730

BIG PLOT Cover, 2-pack



H: 2 cm
 Diameter: 17 cm
 Material: aluminium

- 500 kg load for 1001262
- 800 kg load for 1001254

Options	Prod. no.
● anthracite	1001262
● Stainless steel	1001254

BIG PLOT Cover, 4-pack



800 kg

H: 2 cm
 Diameter: 17 cm
 Material: stainless steel 316

Options	Prod. no.
● anthracite	1001263
● Stainless steel	1001255

ROCCI
EL, square

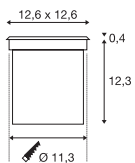

100-277 V ~50/60 Hz | 700 mA
Total wattage: 8.6W
Material: stainless steel 316/glass



Up 580lm | 3000K

Options	Prod. no.
● Stainless steel	227604

ROCCI
EL, round

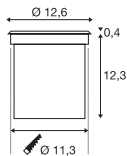

100-277 V ~50/60 Hz | 700 mA
Total wattage: 8.6W
Material: stainless steel 316/glass



Up 580lm | 3000K

Options	Prod. no.
● Stainless steel	227600

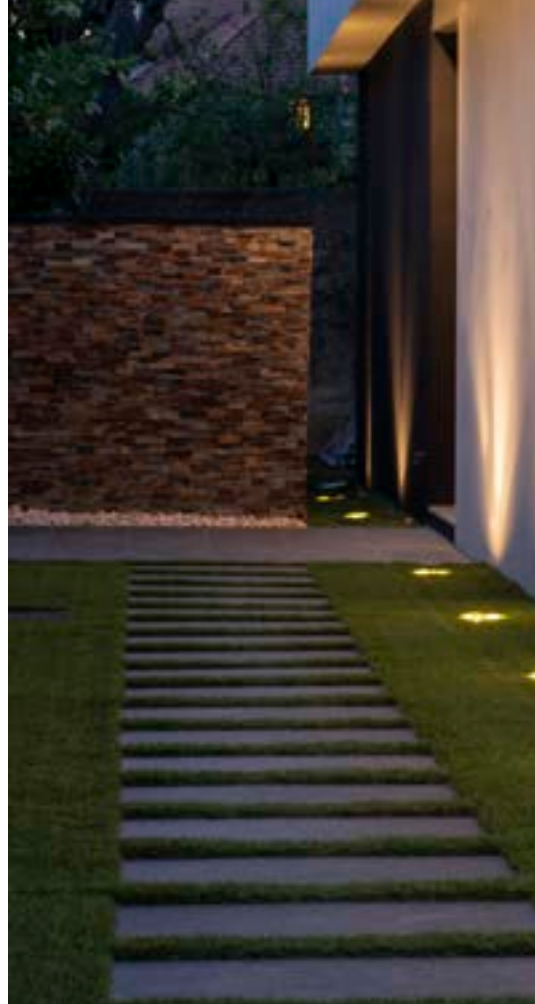



227604 854

ROCCI 200
EL, square

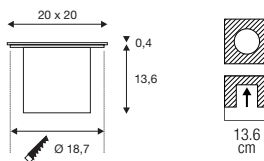

ROCCI 200
EL, round

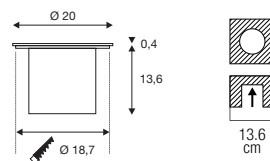

1006105 855

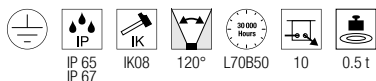

100-277V ~50/60Hz | 350mA
Total wattage: 16W
Material: stainless steel 316/glass



Up 1530lm | 3000K

Options	Prod. no.
● Stainless steel	1006105

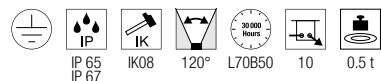

100-277V ~50/60Hz | 350mA
Total wattage: 16W
Material: stainless steel 316/glass



Up 1530lm | 3000K

Options	Prod. no.
● Stainless steel	1006104



227680

857



SOLASTO EL, square

SOLASTO EL, round

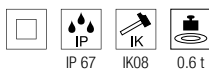
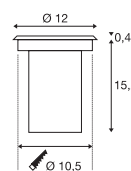
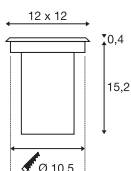

220-240V ~50/60Hz
Material: stainless steel 304/glass

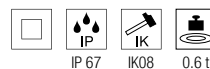

220-240V ~50/60Hz
Material: stainless steel 304/glass



Base: 1xGU10



Base: 1xGU10

Options	Prod. no.
● Stainless steel	227684

Options	Prod. no.
● Stainless steel	227680



LED GU10 51mm | 6W | 38°
2700K | 450lm | EEK=F
6kWh/1000h

Prod. no.: 1005075



LED GU10 51mm | 6W | 38°
2700K | 450lm | EEK=F
6kWh/1000h

Prod. no.: 1005075



1006400 281





LED QT | 860



LED C35 | 860



LED TCR-TSE | 860



LED QR51 | 861



LED QPAR51 | 861



LED | 862

LED QPAR111 |
862, 863, 864

QPAR111 | 862, 863



LED A60 | 864, 865



LED T32 | 861



LED T38 | 865



LED T45 | 865



LED ST64 | 865



LED ST58 | 865



LED G125 | 865

LED QT14 G9

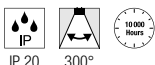

220-240V ~50/60Hz
Wattage: 3.6W
Material: ceramic
Diameter: 1.8 cm L: 5.4 cm

Luminous flux	400lm
Lamp current	0.03A
Colour rendering index	93
Output	3,6W
Energy consumption/1000h	4kWh

Options	Prod. no.
<input type="radio"/> white 3000K	1005286

LED QT-DE12 R7S, 78 mm



220-240V ~50/60Hz
Wattage: 9W
Material: polycarbonate (PC)
Diameter: 2.9 cm L: 2.9 cm

Luminous flux	1050lm
Lamp current	0.043A
Colour rendering index	95
Output	9W
Energy consumption/1000h	9kWh

Options	Prod. no.
<input checked="" type="radio"/> grey 3000K	1005287

LED QT-DE12 R7S, 118 mm



220-240V ~50/60Hz
Wattage: 15W
Material: polycarbonate (PC)
Diameter: 2.9 cm L: 2.9 cm

Luminous flux	2000lm
Lamp current	0.068A
Colour rendering index	92
Output	15W
Energy consumption/1000h	15kWh

Options	Prod. no.
<input checked="" type="radio"/> grey 3000K	1005288

LED C35 E14

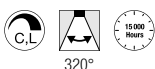

220-240V ~50/60Hz
Wattage: 4.2W
Material: glass
Diameter: 3.5 cm L: 9.8 cm

Luminous flux	380lm
Lamp current	0.025A
Colour rendering index	90
Output	4,2W
Energy consumption/1000h	5kWh

Options	Prod. no.
<input type="radio"/> transparent 2700K	1005284

LED C35 E14

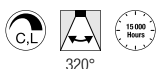

220-240V ~50/60Hz
Wattage: 4.2W
Material: glass
Diameter: 3.5 cm L: 9.8 cm

Luminous flux	350lm
Lamp current	0.025A
Colour rendering index	90
Output	4,2W
Energy consumption/1000h	5kWh

Options	Prod. no.
<input type="radio"/> white 2700K	1005285

LED TCR-TSE GX53

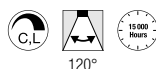

220-240V ~50/60Hz
Wattage: 6.1W
Material: polycarbonate (PC) /
polycarbonate (PC)
Diameter: 7.5 cm L: 2.4 cm

Luminous flux	490lm
Lamp current	0.034A
Colour rendering index	93
Output	6,1W
Energy consumption/1000h	6kWh

Options	Prod. no.
<input type="radio"/> white 2700K	1005272
<input type="radio"/> white 3000K	1005271
<input type="radio"/> white 4000K	1005269

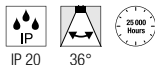
**LED QR51**
GU5.3

12V AC
Wattage: 5.8W
Material: glass
Diameter: 5 cm L: 4.5 cm

Luminous flux	450lm
Lamp current	0.63A
Max. luminosity	1300cd
Colour rendering index	90
Output	5,8W
Energy consumption/1000h	6kWh

Options**Prod. no.**

- transparent
- 2700K**
- transparent
- 3000K**

1001574

1001575

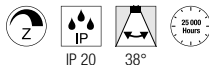
LED QPAR51
GU10, tunable 2700-6500K, smart

220-240V ~50/60Hz
Wattage: 5W
Material: polyamide 66 (PA 66) /
polycarbonate (PC)
Diametr: 5 cm L: 5.4 cm

Luminous flux	350lm
Lamp current	0.04A
Max. luminosity	530cd
Colour rendering index	92
Output	5W
Energy consumption/1000h	5kWh

Options**Prod. no.**

- white
- 2700-6500K**

1005311

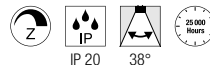
LED QPAR51
GU10, RGBW, smart

220-240V ~50/60Hz
Wattage: 5.2W
Material: polyamide 66 (PA 66) /
polycarbonate (PC)
Diameter: 5 cm L: 6.1 cm

Luminous flux	350lm
Lamp current	0.042A
Max. luminosity	680cd
Colour rendering index	92
Output	5,2W
Energy consumption/1000h	5kWh

Options**Prod. no.**

- white

1005312

LED QPAR51
GU10

NEW

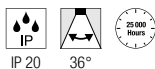

220-240V ~50/60Hz
Wattage: 2.4W
Material: glass
Diameter: 5 cm L: 5.4 cm

Luminous flux	230lm
Lamp current	0.025A
Max. luminosity	450cd
Colour rendering index	80
Output	2,4W
Energy consumption/1000h	3kWh

Options**Prod. no.**

- transparent
- 2700K**
- transparent
- 3000K**

1007230

1007231

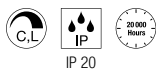
LED T32
GU10

220-240V ~50/60Hz
Wattage: 3.2W
Material: glass
Diameter: 3.2 cm L: 10 cm

Luminous flux	270lm
Lamp current	0.0175A
Colour rendering index	90
Output	3,2W

Options**Prod. no.**

- transparent
- 2700K**

1006321

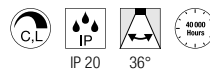
LED QPAR51
GU10

220-240V ~50/60Hz
Wattage: 6W
Material: glass
Diameter: 5 cm L: 5 cm

Luminous flux	360lm
Lamp current	0.033A
Max. luminosity	680cd
Colour rendering index	93
Output	6W
Energy consumption/1000h	6kWh

Options**Prod. no.**

- silver
- 2200-2700K**

1005273

LED QPAR51 GU10

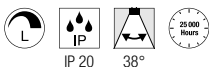

220-240V ~50/60Hz
Wattage: 6W
Material: polycarbonate (PC)
Diameter: 5 cm L: 5 cm

Luminous flux	450lm
Lamp current	0.037A
Max. luminosity	880cd
Colour rendering index	92
Output	6W
Energy consumption/1000h	6kWh

Options	Prod. no.
● black	
2700K	1005077
● black	
3000K	1005080
● black	
4000K	1005083

LED QPAR51 GU10

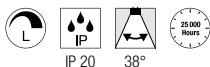

220-240V ~50/60Hz
Wattage: 6W
Material: polycarbonate (PC)
Diameter: 5 cm L: 5 cm

Luminous flux	450lm
Lamp current	0.037A
Max. luminosity	880cd
Colour rendering index	92
Output	6W
Energy consumption/1000h	6kWh

Options	Prod. no.
○ white	
2700K	1005076
○ white	
3000K	1005079
○ white	
4000K	1005082

LED QPAR51 GU10

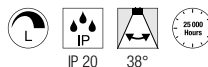

220-240V ~50/60Hz
Wattage: 6W
Material: polycarbonate (PC)
Diameter: 5 cm L: 5.4 cm

Luminous flux	450lm
Lamp current	0.037A
Max. luminosity	880cd
Colour rendering index	92
Output	6W
Energy consumption/1000h	6kWh

Options	Prod. no.
● grey	
2700K	1005075
● grey	
3000K	1005078
● grey	
4000K	1005081

LED QPAR111 GU10

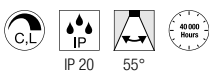

220-240V ~50/60Hz
Wattage: 12W
Material: aluminium
Diameter: 11 cm L: 7 cm

Luminous flux	680lm
Lamp current	0.05A
Max. luminosity	930cd
Colour rendering index	90
Output	12W
Energy consumption/1000h	12kWh

Options	Prod. no.
● aluminium	
2700K	1005297 ●
● aluminium	
3000K	1005298 ●
● aluminium	
4000K	1005299 ●

QPAR111 GU10, RGBW, smart

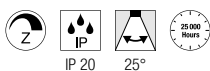

220-240V ~50/60Hz
Wattage: 10W
Material: aluminium
Diameter: 11.1 cm L: 7 cm

Luminous flux	750lm
Lamp current	0.059A
Max. luminosity	3500cd
Colour rendering index	94
Output	10W
Energy consumption/1000h	10kWh

Options	Prod. no.
○ white	1005315

QPAR111 GU10, RGBW, smart

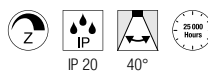

220-240V ~50/60Hz
Wattage: 10W
Material: aluminium/polycarbonate (PC)
Diameter: 11.1 cm L: 7 cm

Luminous flux	780lm
Lamp current	0.059A
Max. luminosity	2000cd
Colour rendering index	94
Output	10W
Energy consumption/1000h	10kWh

Options	Prod. no.
○ white	1005316

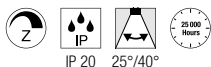
**QPAR111**
GU10, tunable 2700-6500K, smart

220-240V ~50/60Hz
Wattage: 10W
Material: aluminium/polycarbonate (PC)
Diameter: 11.1 cm L: 7 cm

Luminous flux	760lm
Lamp current	0.053A
Max. luminosity	4000cd
Colour rendering index	93
Output	10W
Energy consumption/1000h	10kWh

Options**Prod. no.**

<input type="radio"/> white	
2700-6500K 25°	1005313
<input type="radio"/> white	
2700-6500K 40°	1005314

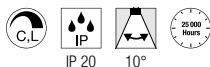
LED QPAR111
GU10

220-240V ~50/60Hz
Wattage: 12.5W
Material: aluminium
Diameter: 11.1 cm L: 7 cm

Luminous flux	900lm
Lamp current	0.058A
Max. luminosity	11000cd
Colour rendering index	90
Output	12,5W
Energy consumption/1000h	13kWh

Options**Prod. no.**

<input type="radio"/> silver	
2700K	1005275
<input type="radio"/> silver	
3000K	1005278
<input type="radio"/> silver	
4000K	1005281

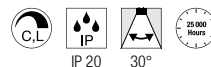
LED QPAR111
GU10

220-240V ~50/60Hz
Wattage: 12.5W
Material: aluminium
Diameter: 11.1 cm L: 7 cm

Luminous flux	950lm
Lamp current	0.058A
Max. luminosity	3000cd
Colour rendering index	93
Output	12,5W
Energy consumption/1000h	13kWh

Options**Prod. no.**

<input type="radio"/> silver	
2700K	1005276
<input type="radio"/> silver	
3000K	1005279
<input type="radio"/> silver	
4000K	1005282

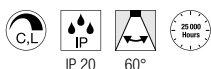
LED QPAR111
GU10

220-240V ~50/60Hz
Wattage: 12.5W
Material: aluminium
Diameter: 11.1 cm L: 7 cm

Luminous flux	1000lm
Lamp current	0.058A
Max. luminosity	1000cd
Colour rendering index	93
Output	12,5W
Energy consumption/1000h	13kWh

Options**Prod. no.**

<input type="radio"/> silver	
2700K	1005277
<input type="radio"/> silver	
3000K	1005280
<input type="radio"/> silver	
4000K	1005283

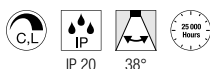
LED QPAR111
GU10

220-240V ~50/60Hz
Wattage: 8W
Material: glass
Diameter: 11.1 cm L: 6.1 cm

Luminous flux	680lm
Lamp current	0.046A
Max. luminosity	1300cd
Colour rendering index	93
Output	8W
Energy consumption/1000h	8kWh

Options**Prod. no.**

<input type="radio"/> transparent	
2700K	1005274

LED QPAR111
GU10

220-240V ~50/60Hz
Wattage: 7.3W
Material: plastic/aluminium
Diameter: 11.1 cm L: 7.1 cm

Luminous flux	530lm
Lamp current	0.051A
Max. luminosity	1400cd
Colour rendering index	93
Output	7,3W
Energy consumption/1000h	8kWh

Options**Prod. no.**

<input type="radio"/> silver	
2700K	1005291
<input type="radio"/> silver	
3000K	1005292

LED QPAR111 GU10

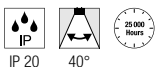

220-240V ~50/60Hz
Wattage: 7.3W
Material: plastic/aluminium
Diameter: 11.1 cm L: 7.1 cm

Luminous flux	500lm
Lamp current	0.051A
Max. luminosity	1000cd
Colour rendering index	93
Output	7.3W
Energy consumption/1000h	8kWh

Options	Prod. no.
<input type="radio"/> silver 2700K	1005294
<input type="radio"/> silver 3000K	1005295
<input type="radio"/> silver 4000K	1005296

LED A60 E27, tunable 2700-6500K, smart

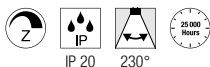

220-240V ~50/60Hz
Wattage: 9W
Material: polyamide 66 (PA 66)
Diameter: 6 cm L: 11 cm

Luminous flux	800lm
Lamp current	0.067A
Colour rendering index	92
Output	9W
Energy consumption/1000h	9kWh

Options	Prod. no.
<input type="radio"/> white 2700-6500K	1005317

LED A60 E27, RGBW, smart

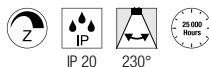

220-240V ~50/60Hz
Wattage: 9W
Material: polyamide 66 (PA 66) / polycarbonate (PC)
Diameter: 6 cm L: 11 cm

Luminous flux	800lm
Lamp current	0.073A
Colour rendering index	92
Output	9W
Energy consumption/1000h	9kWh

Options	Prod. no.
<input type="radio"/> white	1005318

LED A60 E27

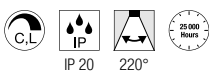

220-240V ~50/60Hz
Wattage: 9W
Material: plastic
Diameter: 6 cm L: 11 cm

Luminous flux	800lm
Lamp current	0.048A
Colour rendering index	90
Output	9W
Energy consumption/1000h	9kWh

Options	Prod. no.
<input type="radio"/> white 2700K	1005301

LED A60 E27

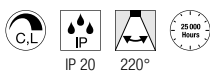

220-240V ~50/60Hz
Wattage: 13.2W
Material: plastic
Diameter: 6 cm L: 12 cm

Luminous flux	1300lm
Lamp current	0.062A
Colour rendering index	93
Output	13.2W
Energy consumption/1000h	13kWh

Options	Prod. no.
<input type="radio"/> white 2700K	1005302

LED A60 E27



220-240V ~50/60Hz
Wattage: 7.5W
Material: glass
Diameter: 6 cm L: 10.5 cm

Luminous flux	800lm
Lamp current	0.038A
Colour rendering index	93
Output	7.5W
Energy consumption/1000h	8kWh

Options	Prod. no.
<input type="radio"/> transparent 2700K	1005303

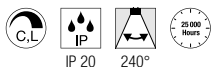
**LED T38**
E27

220-240V ~50/60Hz
Wattage: 8W
Material: plastic
Diameter: 3.8 cm L: 11.6 cm

Luminous flux	880lm
Lamp current	0.035A
Colour rendering index	94
Output	8W
Energy consumption/1000h	8kWh

Options **Prod. no.**

<input type="radio"/> white	
<input type="radio"/> 3000K	1005289
<input type="radio"/> white	
<input type="radio"/> 4000K	1005290

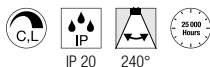
LED T45
E27

220-240V ~50/60Hz
Wattage: 13.5W
Material: plastic
Diameter: 4.5 cm L: 14 cm

Luminous flux	1520lm
Lamp current	0.06A
Colour rendering index	94
Output	13,5W
Energy consumption/1000h	14kWh

Options **Prod. no.**

<input type="radio"/> white	
<input type="radio"/> 3000K	1005307
<input type="radio"/> white	
<input type="radio"/> 4000K	1005308

LED ST64
E27

220-240V ~50/60Hz
Wattage: 7.5W
Material: glass
Diameter: 6.4 cm L: 14.5 cm

Luminous flux	700lm
Lamp current	0.038A
Colour rendering index	90
Output	7,5W
Energy consumption/1000h	8kWh

Options **Prod. no.**

<input checked="" type="radio"/> gold	
<input type="radio"/> 2500K	1005265

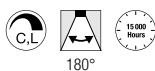
LED A60
E27, Mirrorhead, Chrom

220-240V ~50/60Hz
Wattage: 7.5W
Material: glass
Diameter: 6 cm L: 10.5 cm

Luminous flux	720lm
Lamp current	0.038A
Colour rendering index	92
Output	7,5W
Energy consumption/1000h	8kWh

Options **Prod. no.**

<input checked="" type="radio"/> chrome	
<input type="radio"/> 2700K	1005305

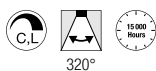
LED ST58
E27

220-240V ~50/60Hz
Wattage: 7.5W
Material: glass
Diameter: 5.8 cm L: 14.2 cm

Luminous flux	800lm
Lamp current	0.038A
Colour rendering index	93
Output	7,5W
Energy consumption/1000h	8kWh

Options **Prod. no.**

<input type="radio"/> transparent	
<input type="radio"/> 2700K	1005268

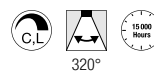
LED G125
E27

220-240V ~50/60Hz
Wattage: 7.5W
Material: glass
Diameter: 12.5 cm L: 17.8 cm

Luminous flux	800lm
Lamp current	0.038A
Colour rendering index	93
Output	7,5W
Energy consumption/1000h	8kWh

Options **Prod. no.**

<input type="radio"/> transparent	
<input type="radio"/> 2700K	1005310



1007300 151

1007308 151

1002913 189



TENSEO
TRANSFORMER | 868



TRANSFORMER | 868



DALI INTERFACE | 868



CONVERTER | 868



DALI UNIVERSAL
DIMMER | 869



DALI
CONTROLLER | 869



CONTROLLER | 869



LED POWER
SUPPLY | 869,
870, 871



DIMMABLE LED
POWER SUPPLY |
871, 872



LED DRIVER | 870,
872, 875, 876, 877



DIMMABLE
LED DRIVER | 871,
872, 873, 874, 875



RF MODULE | 874, 875



CEILING HOOK | 878



CABLE CLAMP | 878



GLENOS® CEILING
ROSETTE | 878



TEXTILE CABLE | 878



CABLE, 3-POLE | 878



WIRE ROPE
SUSPENSION | 878



STOPPER FOR
WIRE ROPE | 879



CABLE
EXTENSION | 879



CONNECTOR
STRIP | 879



DOUBLE-SIDED
TAPE | 879



GU10 LED
CONNECTION
BOX | 880



GU10 CONNECTION
BOX | 880



GU10 SOCKET | 880



CONNECTION
BOX | 881



T-CONNECTOR
BOX | 881



CONNECTION
BOX | 881

TENSEO TRANSFORMER
12V AC | 50VA conventional



220-240V ~50/60Hz
H: 11 cm
Diameter: 11.1 cm
Material: steel/brass

Output voltage	12V AC
Wattage up to	60W
Thermal protection	130°C
Number of secondary outputs	1

Options	Prod. no.
<input checked="" type="radio"/> black	1002691
<input type="radio"/> white	1002692
<input type="radio"/> chrome	1002693

TENSEO TRANSFORMER
12V AC | 105VA conventional



220-240V ~50/60Hz
H: 11 cm
Diameter: 11.1 cm
Material: brass/glass

Output voltage	12V AC
Wattage up to	105W
Thermal protection	130°C
Number of secondary outputs	1

Options	Prod. no.
<input type="radio"/> white	138981
<input checked="" type="radio"/> chrome	138982

TENSEO TRANSFORMER
12V AC | 210VA conventional

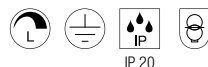

220-240V ~50/60Hz
H: 11 cm
Diameter: 13.5 cm
Material: steel/brass

Output voltage	12V AC
Wattage up to	210W
Thermal protection	130°C
Number of secondary outputs	1

Options	Prod. no.
<input type="radio"/> white	138991
<input checked="" type="radio"/> chrome	138992

TRANSFORMER
60VA | 12V AC



230V ~50Hz
L: 10.5 cm W: 3.3 cm H: 2.2 cm
Material: polycarbonate (PC)

Output voltage	12V AC
Wattage of	10W
Wattage up to	60W
Control gear power factor	0.98
Thermal protection	110°C
Number of secondary outputs	1

Options	Prod. no.
<input type="radio"/> white	461060

DALI INTERFACE
1-10V + on/off

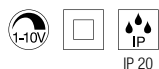

250V AC
L: 5.85 cm W: 3.25 cm H: 1.5 cm
Material: plastic

- Suitable for controlling electronic ballasts with 1-10V control input
- Galvanic isolation of DALI input and 1-10V output

Output voltage	250V AC
Wattage up to	1000W

Options	Prod. no.
<input checked="" type="radio"/> grey	1002218

CONVERTER
Phase dim -> DALI



100-240V ~50/60Hz
L: 4.6 cm W: 4.5 cm H: 2 cm
Material: polycarbonate (PC)

Output voltage	100-240V AC
Wattage of	0W
Wattage up to	200W

Options	Prod. no.
<input type="radio"/> white	1006452



DALI UNIVERSAL DIMMER 10-300W



230V AC
L: 12.02 cm W: 3.02 cm H: 2.16 cm
Material: plastic

- Suitable for R, L, and C thanks to automatic load detection.
DALI power consumption: 6mA

Output voltage	230V AC
Wattage of	10W
Wattage up to	300W

Options	Prod. no.
<input checked="" type="radio"/> grey	1002221

DALI CONTROLLER 24V DC

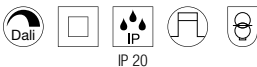

10V-24V DC
L: 11.6 cm W: 4.2 cm H: 1.8 cm
Material: polycarbonate (PC)

Output voltage	10-24V DC
Number of secondary outputs	1

Options	Prod. no.
<input checked="" type="radio"/> white/grey	1003106

CONTROLLER LED Stip CCT / RGBW



12V/24V DC
L: 14.5 cm W: 4.65 cm H: 1.6 cm
Material: polycarbonate (PC)

Output voltage	12-24V DC
Wattage of	48W
Wattage up to	96W
Thermal protection	100°C

Options	Prod. no.
<input type="radio"/> white	1006348

LED POWER SUPPLY 15W | 12V

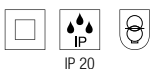

200-240V ~50/60Hz
H: 2.5 cm
Diameter: 5.5 cm
Material: polycarbonate (PC)

Output voltage	12V DC
Wattage of	0W
Wattage up to	15W
Control gear power factor	0.9
Thermal protection	110°C
Number of secondary outputs	1

Options	Prod. no.
<input type="radio"/> white	1005444

LED POWER SUPPLY 15W | 24V

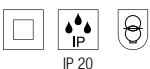

200-240V ~50/60Hz
H: 2.2 cm
Diameter: 5.5 cm
Material: polycarbonate (PC)

Output voltage	24V DC
Wattage of	0W
Wattage up to	15W
Control gear power factor	0.9
Thermal protection	110°C
Number of secondary outputs	1

Options	Prod. no.
<input type="radio"/> white	1005445

LED POWER SUPPLY 20W | 12/24V

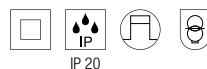

220-240V ~50/60Hz
L: 11.5 cm W: 4.1 cm H: 2.5 cm
Material: polycarbonate (PC)

Output voltage	12/24V DC
Wattage of	0W
Wattage up to	18W/20W
Control gear power factor	0.95
Thermal protection	110°C
Number of secondary outputs	1

Options	Prod. no.
<input type="radio"/> white	1005381

LED DRIVER
30W | 24V DC incl. strain relief

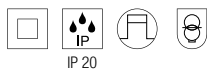

220-240V ~50/60Hz
L: 30 cm W: 3 cm H: 1.6 cm
Material: polycarbonate (PC)

Output voltage	24V DC
Wattage of	0W
Wattage up to	30W
Control gear power factor	0.95
Thermal protection	110°C
Number of secondary outputs	1

Options	Prod. no.
<input type="radio"/> white	1007250 ●

LED DRIVER
100W | 24V DC incl. strain relief

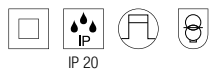

220-240V ~50/60Hz
L: 35 cm W: 3 cm H: 1.8 cm
Material: polycarbonate (PC)

Output voltage	24V DC
Wattage of	0W
Wattage up to	100W
Control gear power factor	0.95
Thermal protection	110°C
Number of secondary outputs	1

Options	Prod. no.
<input type="radio"/> white	1007251 ●

LED DRIVER
150W | 24V DC incl. strain relief

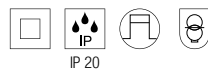

220-240V ~50/60Hz
L: 35 cm W: 3 cm H: 1.8 cm
Material: polycarbonate (PC)

Output voltage	24V DC
Wattage of	0W
Wattage up to	150W
Control gear power factor	0.95
Thermal protection	110°C
Number of secondary outputs	1

Options	Prod. no.
<input type="radio"/> white	1007252 ●

LED DRIVER
250W | 24V DC incl. strain relief

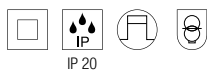

220-240V ~50/60Hz
L: 40 cm W: 4 cm H: 2.2 cm
Material: polycarbonate (PC)

Output voltage	24V DC
Wattage of	0W
Wattage up to	250W
Control gear power factor	0.95
Thermal protection	110°C
Number of secondary outputs	1

Options	Prod. no.
<input type="radio"/> white	1007253 ●

LED POWER SUPPLY
25W | 24V

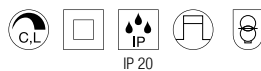

220-240V ~50/60Hz
L: 12.8 cm W: 5.2 cm H: 3 cm
Material: polycarbonate (PC) / polycarbonate (PC)

Output voltage	24V DC
Wattage of	9.6W
Wattage up to	25W
Control gear power factor	0.95
Thermal protection	110°C
Number of secondary outputs	1

Options	Prod. no.
<input type="radio"/> white/grey	1006336 ●

LED POWER SUPPLY
50W | 24V

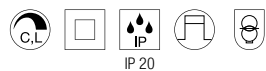

220-240V ~50/60Hz
L: 18.4 cm W: 6.1 cm H: 3.2 cm
Material: polycarbonate (PC) / polycarbonate (PC)

Output voltage	24V DC
Wattage of	12W
Wattage up to	50W
Control gear power factor	0.95
Thermal protection	110°C
Number of secondary outputs	1

Options	Prod. no.
<input type="radio"/> white/blue	1003104



LED POWER SUPPLY 100W | 24V DC

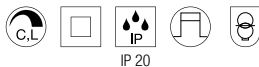

220-240V ~50/60Hz
L: 21 cm W: 6.7 cm H: 3.4 cm
Material: polycarbonate (PC) /
polycarbonate (PC)

Output voltage	24V DC
Wattage of	33W
Wattage up to	100W
Control gear power factor	0.95
Thermal protection	110°C
Number of secondary outputs	1

Options	Prod. no.
<input checked="" type="radio"/> white/blue	1003105

LED DRIVER 30W | 24V DC DALI dimmable incl. strain relief

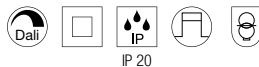

220-240V ~50/60Hz
L: 30 cm W: 3 cm H: 1.6 cm
Material: polycarbonate (PC)

Output voltage	24V DC
Wattage of	12W
Wattage up to	30W
Control gear power factor	0.95
Thermal protection	110°C
Number of secondary outputs	1

Options	Prod. no.
<input type="radio"/> white	1007254

LED DRIVER 100W | 24V DC DALI dimmable incl. strain relief

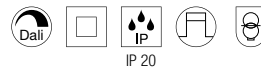

220-240V ~50/60Hz
L: 35 cm W: 3 cm H: 1.8 cm
Material: polycarbonate (PC)

Output voltage	24V DC
Wattage of	30W
Wattage up to	100W
Control gear power factor	0.95
Thermal protection	110°C
Number of secondary outputs	1

Options	Prod. no.
<input type="radio"/> white	1007255

LED DRIVER 150W | 24V DC DALI dimmable incl. strain relief

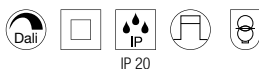

220-240V ~50/60Hz
L: 35 cm W: 3 cm H: 1.8 cm
Material: polycarbonate (PC)

Output voltage	24V DC
Wattage of	45W
Wattage up to	150W
Control gear power factor	0.95
Thermal protection	110°C
Number of secondary outputs	1

Options	Prod. no.
<input type="radio"/> white	1007256

LED DRIVER 250W | 24V DC DALI dimmable incl. strain relief

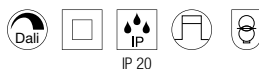

220-240V ~50/60Hz
L: 40 cm W: 4 cm H: 2.2 cm
Material: polycarbonate (PC)

Output voltage	24V DC
Wattage of	75W
Wattage up to	250W
Control gear power factor	0.95
Thermal protection	110°C
Number of secondary outputs	1

Options	Prod. no.
<input type="radio"/> white	1007257

LED POWER SUPPLY 60W | DALI, 24V, 2 channel DALI dimmable

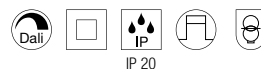

220-240V ~50/60Hz
L: 20.2 cm W: 5.8 cm H: 3 cm
Material: polycarbonate (PC)

Output voltage	24V DC
Wattage of	5W
Wattage up to	60W
Control gear power factor	0.95
Thermal protection	110°C
Number of secondary outputs	2

Options	Prod. no.
<input type="radio"/> white	1006133

LED POWER SUPPLY
100W | 24V | 2 channel DALI
dimmable

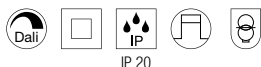

220-240V ~50/60Hz
L: 34.7 cm W: 4 cm H: 2.2 cm
Material: polycarbonate (PC)

Wattage of	5W
Wattage up to	100W
Control gear power factor	0.95
Thermal protection	110°C
Number of secondary outputs	2

Options	Prod. no.
<input type="radio"/> white	1006134

LED DRIVER
10W | 200mA | dimmable including
strain relief

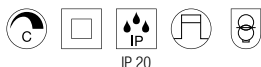

220-240V ~50/60Hz
L: 8.5 cm W: 4.1 cm H: 2.2 cm
Material: polycarbonate (PC)

Output voltage	30-42V DC
Wattage of	6W
Wattage up to	8.4W
Control gear power factor	0.9
Thermal protection	110°C
Number of secondary outputs	1

Options	Prod. no.
<input type="radio"/> white	1007215 ●

LED DRIVER
6W | 350mA | Dimmable



220-240V ~50/60Hz
L: 6.3 cm W: 4 cm H: 2.3 cm
Material: polycarbonate (PC)

Output voltage	10-17V DC
Wattage of	3.5W
Wattage up to	5.9W
Control gear power factor	0.9
Thermal protection	110°C
Number of secondary outputs	1

Options	Prod. no.
<input type="radio"/> white	1002791

LED DRIVER
20W | 350mA | Dimmable

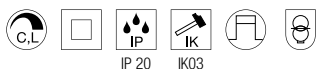

220-240V 0/~50/60Hz
L: 11.6 cm W: 4.1 cm H: 2.5 cm
Material: polycarbonate (PC)

Output voltage	28-50V DC
Wattage of	9.8W
Wattage up to	17.5W
Control gear power factor	0.95
Thermal protection	110°C
Number of secondary outputs	1

Options	Prod. no.
<input type="radio"/> white	1007228 ●

LED DRIVER
20W | 350mA/500mA | PHASE

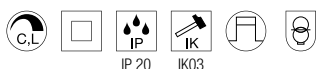

220-240V 0/~50/60Hz
L: 11.6 cm W: 4.1 cm H: 2.5 cm
Material: polycarbonate (PC)

Output voltage	10-30V DC
Wattage of	3.5W
Wattage up to	15W
Control gear power factor	0.95
Thermal protection	110°C
Number of secondary outputs	1

Options	Prod. no.
<input type="radio"/> white	1007227 ●

LED DRIVER
700mA | PHASE

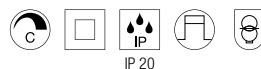

220-240V ~50/60Hz
L: 8.5 cm W: 4.1 cm H: 2.2 cm
Material: polycarbonate (PC)

Output voltage	8.6-12.9V DC
Wattage of	6W
Wattage up to	9W
Control gear power factor	0.9
Thermal protection	110°C
Number of secondary outputs	1

Options	Prod. no.
<input type="radio"/> white	1007213 ●



LED DRIVER

20W | 700mA | Dimmable

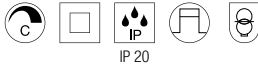

200-240V ~50/60Hz
L: 11.5 cm W: 4.1 cm H: 2.5 cm
Material: polycarbonate (PC)

Output voltage	18-26V DC
Wattage of	12.6W
Wattage up to	18.2W
Control gear power factor	0.9
Thermal protection	110°C
Number of secondary outputs	1

Options	Prod. no.
<input type="radio"/> white	1006202

LED DRIVER

40W | 700mA | Dimmable

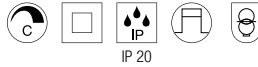

200-240V ~50/60Hz
L: 14.5 cm W: 4 cm H: 3 cm
Material: polycarbonate (PC)

Output voltage	32-54V DC
Wattage of	22.4W
Wattage up to	37.8W
Control gear power factor	0.9
Thermal protection	110°C
Number of secondary outputs	1

Options	Prod. no.
<input type="radio"/> white	1005446

LED DRIVER

40W | 1050mA | Dimmable

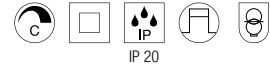

220-240V ~50/60Hz
L: 16.6 cm W: 5.2 cm H: 2.4 cm
Material: polycarbonate (PC)

Output voltage	22-43V DC
Wattage of	23W
Wattage up to	45W
Control gear power factor	0.95
Thermal protection	110°C
Number of secondary outputs	1

Options	Prod. no.
<input type="radio"/> white	464804

LED DRIVER

40W | 1000mA | Dimmable

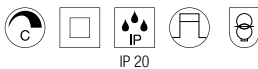

220-240V ~50/60Hz
L: 14.5 cm W: 4 cm H: 3 cm
Material: polycarbonate (PC)

Output voltage	25-40V DC
Wattage of	26.3W
Wattage up to	42W
Control gear power factor	0.9
Thermal protection	110°C
Number of secondary outputs	1

Options	Prod. no.
<input type="radio"/> white	1005387

LED DRIVER

25W | 150-700mA | DALI dimmable

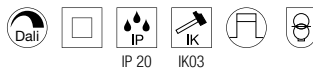

220-240V 0/~50/60Hz
L: 11.9 cm W: 5.2 cm H: 2.25 cm
Material: polycarbonate (PC)

Output voltage	2-50V DC
Wattage of	0.3W
Wattage up to	25W
Control gear power factor	0.95
Thermal protection	110°C
Number of secondary outputs	1

Options	Prod. no.
<input type="radio"/> white	1007229

LED DRIVER

25W | 150-300mA | DALI dimmable

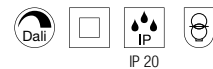

220-240V ~50/60Hz
L: 14.18 cm W: 4.38 cm H: 3 cm
Material: polycarbonate (PC)

Output voltage	10-40V DC
Wattage of	1.5W
Wattage up to	12W
Control gear power factor	0.9
Thermal protection	110°C
Number of secondary outputs	1

Options	Prod. no.
<input type="radio"/> white	1006456

RF MODULE for DALI driver



L: 4.3 cm W: 3.1 cm H: 1.2 cm
Material: polycarbonate (PC)

- Zigbee 3.0 Single Colour

RF MODULE for DALI driver



L: 4.3 cm W: 3.1 cm H: 1.2 cm
Material: polycarbonate (PC)

- Casambi

LED DRIVER 12W | 250mA DALI dimmable with RF interface



220-240V ~50/60Hz
L: 14.18 cm W: 4.38 cm H: 3 cm
Material: polycarbonate (PC)

Output voltage	10-40V DC
Wattage of	1.5W
Wattage up to	12W
Control gear power factor	0.9
Thermal protection	110°C
Number of secondary outputs	1

Options	Prod. no.
<input type="radio"/> white	1006199 ●

Options	Prod. no.
<input type="radio"/> white	1006454 ●

Options	Prod. no.
<input type="radio"/> white	1006194 ●

LED DRIVER 40W | 500mA DALI dimmable with RF interface



220-240V ~50/60Hz
L: 12.3 cm W: 7.9 cm H: 3 cm
Material: polycarbonate (PC)

Output voltage	10-42V DC
Wattage of	5W
Wattage up to	42W
Control gear power factor	0.95
Thermal protection	110°C
Number of secondary outputs	1

LED DRIVER 40W | 700mA DALI dimmable with RF interface



220-240V ~50/60Hz
L: 12.3 cm W: 7.9 cm H: 3 cm
Material: polycarbonate (PC)

Output voltage	10-42V DC
Wattage of	5W
Wattage up to	42W
Control gear power factor	0.95
Thermal protection	110°C
Number of secondary outputs	1

Options	Prod. no.
<input type="radio"/> white	1006196 ●

LED DRIVER 40W | 1050mA DALI dimmable with RF interface



220-240V ~50/60Hz
L: 12.3 cm W: 7.9 cm H: 3 cm
Material: polycarbonate (PC)

Output voltage	10-40V DC
Wattage of	5W
Wattage up to	42W
Control gear power factor	0.95
Thermal protection	110°C
Number of secondary outputs	1

Options	Prod. no.
<input type="radio"/> white	1006197 ●



LED DRIVER

20W | 250-700mA 1-10V/DALI dimmable



220-240V ~50/60Hz
L: 15 cm W: 5.2 cm H: 2.8 cm
Material: polycarbonate (PC)

Output voltage	6-60V DC
Wattage of	1.5W
Wattage up to	20W
Control gear power factor	0.9
Thermal protection	110°C
Number of secondary outputs	1

Options	Prod. no.
<input type="radio"/> white	1002423

LED DRIVER

40W | 500-1050mA 1-10V/DALI dimmable

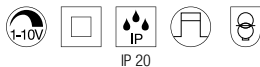

220-240V ~50/60Hz
L: 12.3 cm W: 7.9 cm H: 2.4 cm
Material: polycarbonate (PC)

Output voltage	9-58V DC
Wattage of	4.5W
Wattage up to	40W
Control gear power factor	0.9
Thermal protection	110°C
Number of secondary outputs	1

Options	Prod. no.
<input type="radio"/> white	1002424

LED DRIVER

50W | 700-1500mA 1-10V/DALI dimmable

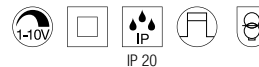

220-240V ~50/60Hz
L: 12.3 cm W: 7.9 cm H: 2.4 cm
Material: polycarbonate (PC)

Output voltage	6-58V DC
Wattage of	4.2W
Wattage up to	50W
Control gear power factor	0.9
Thermal protection	110°C
Number of secondary outputs	1

Options	Prod. no.
<input type="radio"/> white	1002425

LED DRIVER

40W | 1050mA DALI CCT tunable



NEW

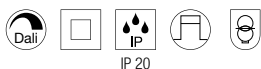

220-240V ~50/60Hz
L: 12.3 cm W: 7.9 cm H: 3 cm
Material: polycarbonate (PC)

Output voltage	10-40V DC
Wattage of	5W
Wattage up to	42W
Control gear power factor	0.9
Thermal protection	110°C
Number of secondary outputs	7

Options	Prod. no.
<input type="radio"/> white	1006198

RF MODULE

for DALI driver



NEW



L: 4.3 cm W: 3.1 cm H: 1.2 cm
Material: polycarbonate (PC)

- Zigbee 3.0 Dual Colour

Options	Prod. no.
<input type="radio"/> white	1006455

LED DRIVER

10W | 250mA



220-240V ~50/60Hz
L: 6.5 cm W: 3.9 cm H: 2 cm
Material: polycarbonate (PC)

Output voltage	26-40V DC
Wattage of	6.5W
Wattage up to	10W
Control gear power factor	0.9
Thermal protection	110°C
Number of secondary outputs	1

Options	Prod. no.
<input type="radio"/> white	1004780

LED DRIVER
3W | 350mA



100-240V ~50/60Hz
L: 6.5 cm W: 2.9 cm H: 1.8 cm
Material: polycarbonate (PC)

Output voltage	2,7-10V DC
Wattage of	1W
Wattage up to	3,5W
Control gear power factor	0.4
Thermal protection	110°C
Number of secondary outputs	1

Options	Prod. no.
<input type="radio"/> white	1005248 ●

LED DRIVER
3W | 350mA AMP socket included

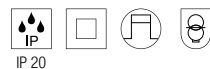

100-240V ~50/60Hz
L: 6.5 cm W: 2.9 cm H: 1.8 cm
Material: polycarbonate (PC)

Output voltage	2,7-10V DC
Wattage of	1W
Wattage up to	3.5W
Control gear power factor	0.4
Thermal protection	110°C
Number of secondary outputs	1

Options	Prod. no.
<input type="radio"/> white	1007270 ●

LED DRIVER
20W | 350mA



220-240V 0/~50/60Hz
L: 11.6 cm W: 4.1 cm H: 2.5 cm
Material: polycarbonate (PC)

Output voltage	2-54V DC
Wattage of	0.7W
Wattage up to	19W
Control gear power factor	0.95
Thermal protection	110°C
Number of secondary outputs	1

Options	Prod. no.
<input type="radio"/> white	1007225 ●

LED DRIVER
21W | 500mA including strain relief



220-240V 0/~50/60Hz
L: 11.6 cm W: 4.1 cm H: 2.5 cm
Material: polycarbonate (PC)

Output voltage	2-42V DC
Wattage of	1W
Wattage up to	21W
Control gear power factor	0.95
Thermal protection	110°C
Number of secondary outputs	1

Options	Prod. no.
<input type="radio"/> white	1007226 ●

LED DRIVER
3W | 700mA including strain relief

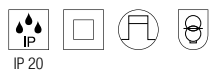

100-240V ~50/60Hz
L: 6.5 cm W: 2.9 cm H: 1.8 cm
Material: polycarbonate (PC)

Output voltage	2,7-4V DC
Wattage of	1.9W
Wattage up to	2.8W
Control gear power factor	0.4
Thermal protection	110°C
Number of secondary outputs	1

Options	Prod. no.
<input type="radio"/> white	1007216 ●

LED DRIVER
30W | 700mA



220-240V ~50/60Hz
L: 14.7 cm W: 4.3 cm H: 3 cm
Material: polycarbonate (PC)

Output voltage	30-42V DC
Wattage of	21W
Wattage up to	29,5W
Control gear power factor	0.9
Thermal protection	110°C
Number of secondary outputs	1

Options	Prod. no.
<input type="radio"/> white	1004781



LED DRIVER

40W | 1050mA



220-240V ~50/60Hz
L: 14.7 cm W: 4.3 cm H: 3 cm
Material: polycarbonate (PC)

Output voltage	30-42V DC
Wattage of	31.5W
Wattage up to	44W
Control gear power factor	0.9
Thermal protection	110°C
Number of secondary outputs	1

Options

white

Prod. no.

1004782

LED DRIVER

40W | 700/900/1000mA



IP 20

120-277V ~50/60Hz
L: 12.3 cm W: 7.9 cm H: 3 cm
Material: polycarbonate (PC)

Output voltage	28-52V DC
Wattage of	19.6W
Wattage up to	40W
Control gear power factor	0.9
Thermal protection	110°C
Number of secondary outputs	3

Options

white

Prod. no.

1006120



1005350 86

CEILING HOOK



L: 4.6 cm
Diameter: 1.8 cm
Material: aluminium

CABLE CLAMP



L: 3.1 cm
Diameter: 1.4 cm
Material: aluminium

GLENOS® Ceiling rosette



220-240V ~50/60Hz
L: 8.5 cm W: 8.5 cm H: 2.7 cm
Material: aluminium

Nominal voltage	220-240V ~50/60Hz
Max. current load	8.5A

Options	Prod. no.
● black	132670
○ white	132671

Options	Prod. no.
● black	132680
○ white	132681

Options	Prod. no.
● black	210060
○ white	210061
● grey	210064

TEXTILE CABLE 3-pin, 10 m



L: 1000 cm
Diameter: 0.6 cm
Material: polyvinyl chloride (PVC)/textile

Max. voltage 300V ACV

Options	Prod. no.
● black	961270

CABLE 3-pin, 3 x 0,75 mm², 10 m



L: 1000 cm

Max. voltage 300V ACV

Options	Prod. no.
○ transparent	961250

WIRE ROPE SUSPENSION



L: 500cm
Diameter: 0.15 cm
Material: steel/plastic

Options	Prod. no.
● silver	961037



STOPPER FOR WIRE ROPE



IP 20

Diameter: 0.7 cm
Material: steel

CABLE EXTENSION



IP 20

L: 100 cm
Material: plastic

- With amp plug and socket

Max. current load 0.35A

Options Prod. no.

- grey

961034

Options Prod. no.

- white

111861

CONNECTOR STRIP
3 outlets

IP 20

L: 5.2 cm W: 1.4 cm H: 1.3 cm
Material: plastic

DOUBLE-SIDED TAPE



L: 300 cm W: 0.9 cm

Max. current load 0.35A

Options Prod. no.

- black

111850

Options Prod. no.

- transparent

220000



1000735 699

GU10 LED CONNECTION BOX with base, max. 10W

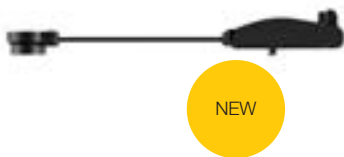

L: 3.8 cm W: 3.1 cm H: 1.7 cm
Material: plastic

GU10 CONNECTION BOX with base, universal



220-240V ~50/60Hz
L: 2.8 cm W: 2.8 cm H: 3.7 cm
Material: ceramic/plastic

- Cable length 15 cm

GU10 SOCKET



230V ~50Hz
H: 1.6 cm
Diameter: 2.8 cm
Material: ceramic

- Cable length 15 cm

Nominal voltage 230V ~50Hz

Options	Prod. no.
● black	1007283 ●

Options	Prod. no.
● white/black	1000909

Options	Prod. no.
○ white	955135



CONNECTION BOX IP68, 3-pin



IP 68

230V ~50Hz
L: 11.5 cm
Diameter: 2.7 cm
Material: polyamide (PA)

Nominal voltage	230V ~50Hz
Max. voltage	450V ACV
Max. current load	17.5A

Options	Prod. no.
● black	228730

T-CONNECTOR BOX IP68, 3-pin



IP 68

230V ~50Hz
L: 11 cm W: 6.4 cm H: 3 cm
Material: polyamide (PA)

Nominal voltage	230V ~50Hz
Max. voltage	500V DCV
Max. current load	17.5A

Options	Prod. no.
● black	228726

CONNECTION BOX IP68, 5-pin



IP 68

230V ~50Hz
L: 13 cm
Diameter: 3.2 cm
Material: polyamide (PA)

Nominal voltage	230V ~50Hz
Max. voltage	450V ACV
Max. current load	32A

Options	Prod. no.
● black	228725

CONNECTION BOX IP68, 5-pin, DALI



NEW



IP 68

450V
L: 18 cm W: 6.3 cm H: 3.3 cm
Material: polyamide 66 (PA 66)

Nominal voltage	450V
Max. current load	16A

Options	Prod. no.
● black	1006453 ●

NUMINOS®





	Recessed lights	83 – 87, 91 – 93
	Wall and ceiling lights	99 – 101
	Ceiling lights	103 – 105
	Pendant lights	106 – 109
	3-phase busbars	110 – 113, 115
	48V system	469 – 471
	Accessory parts	94 – 95

Or simply configure your system online at: numinos.slv.com

NEW TRIA®

	Recessed lights	122 – 147
---	-----------------------	-----------





MEDO®

	Wall and ceiling lights	148 – 161
	Ceiling lights	164 – 165
	Pendant lights	166 – 167
	Recessed lights	168 – 169

LALU®

	Pendant lights	176 – 183
---	----------------------	-----------

ONE®

	Pendant lights	186 – 191
	Wall and ceiling lights	192 – 193
	3-phase busbars	194 – 195
	Table and floor lamps	196 – 199

Please note: 7-digit product no. can be found from page 886

111000		117351	262	143021	495
111262	238			143022	495
111292	239	132000		143030	497
111362	145	132020	409	143031	497
111382	145	132021	409	143032	497
111850	879	132024	409	143040	497
111861	879	132600	279, 281, 283, 295, 305, 309, 318	143041	497
		132601	279, 281, 283, 295, 305, 307, 309	143042	497
112000		132605	279, 281, 283, 295, 305, 309	143050	497
112221	227	132610	295, 305	143051	497
112222	227	132611	295, 305	143052	497
112225	227	132660	296	143060	497
112242	234	132661	296	143061	497
112682	227	132662	296	143062	497
112692	227	132670	878	143070	497
112720	238	132671	878	143071	497
112721	238	132680	878	143072	497
112780	238, 239, 240	132681	878	143080	497
112781	238, 239, 240	132690	295	143081	497
112910	220	132691	295	143082	497
112911	220	132835	660	143090	497
				143091	497
113000		133000		143092	497
113140	219	133009	309	143100	497
113141	219	133019	309	143101	497
113150	219	133050	309	143102	497
113151	219	133060	309	143110	497
113160	220	133444	307	143111	497
113161	220	133481	314	143112	497
113170	221	133482	314	143120	279
113171	221	133489	314	143121	279
113262	238	133490	314	143124	279
113292	239	133840	167	143130	497
113492	145	133841	167	143131	497
113512	145	133850	167	143132	497
113540	145	133851	167	143151	497
113541	145			143152	497
113550	145	135000		143160	497
113830	145	135250	153, 157, 161, 165	143161	497
113840	145	135251	153, 157, 161, 165	143162	497
113841	145	135254	153, 157, 161, 165	143169	497
113890	141			143170	497, 499
113891	141	138000		143171	497, 499
113930	257	138981	868	143172	497, 499
113931	257	138982	868	143190	513
113940	257	138991	868	143191	513
113941	257	138992	868	143221	499
113970	141			143230	499
113971	141	139000		143231	499
113976	141	139004	483	143241	499
		139006	484	143251	499
114000		139024	482	143261	499
114420	245	139026	483	143271	499
114421	245	139030	482	143281	499
114426	245	139031	482	143350	521
114430	245	139040	483	143351	521
114431	245	139041	483	143354	521
114436	245	139050	483	143380	497
114440	246	139051	483	143381	497
114441	246	139060	484	143382	497
114450	247	139061	484	143390	513
114451	247	139070	486	143391	513
114480	232	139071	486	143392	513
114481	232	139072	486	143430	519
		139080	486	143431	519
115000		139081	486	143432	519
115510	214	139082	486	143440	519
115511	214	139090	487	143441	519
115520	214	139091	487	143442	519
115521	214	139092	487	143450	515
115530	214	139100	489	143451	515
115531	214	139101	489	143454	515
115540	215	139102	489	143540	520
115541	215	139120	491	143541	520
115550	215	139121	491	143544	520
115551	215	139122	491	143580	507
		139130	489	143581	507
117000		139131	489	143594	511
117100	265	139132	489	143621	511
117101	265			143731	520
117110	265	143000		143811	521
117111	265	143010	495	143930	512
117311	230	143011	495	143932	512
117321	262	143012	495	143941	516
117331	230	143020	495	143951	517

143960	517	151456	367	155530	312
143961	517	151511	263	155540	447
143990	509	151514	263	155550	266
143991	509	151531	263, 408	155551	266
144000		151534	263, 408	155582	267, 297, 449
144010	511	151591	373	155583	267, 297, 449
144011	511	151710	368	155592	267, 297, 449
144019	511	151711	368	155714	306
144200	515	151740	368	155752	375
144201	515	151741	368	155780	447
144204	515	151781	329	155790	447
		151786	329	155910	313
		151791	329	155930	313
		151796	329		
145000		151800	379	156000	
145990	279, 281, 283, 295, 305, 309	151801	379	156050	268
145994	279, 281, 283, 295, 305, 309	151803	379	156051	268
146000		151810	259	156100	297
146010	453	151811	259	156111	267, 297, 449
146332	389	151830	407	156113	267, 297, 449
146682	387	151831	407	156122	267, 297, 449
146692	387	151840	259, 379, 407	156141	296, 448
		151850	305	156143	296, 448
147000		151851	305	156152	296, 448
147301	405	151853	305		
147306	405	151950	242	158000	
147311	405	151952	242	158400	301
147316	405	151960	242	158410	303
147321	405	151962	242	158799	243
147326	405				
147360	411	152000		161000	
147361	411	152010	407	161271	231
147370	411	152011	407	161291	231
147371	411	152020	407	161461	272
147380	411	152021	407		
147381	411	152101	259	165000	
147441	415	152230	541	165358	319
147442	415	152231	541	165359	319
147443	415	152232	541	165390	317
147444	415	152240	541	165400	317
147529	373	152241	541	165410	317
147550	409	152242	541		
147551	409	152320	538	181000	
147559	409	152321	538	181530	485
		152330	399	181531	485
		152331	399	181532	485
148000		152340	383		
148001	271	152341	383	186000	
148002	271	152360	301	186300	485
148004	270	152370	303	186301	485
148005	271	152380	232	186302	485
148010	357	152381	232	186310	485
148012	361	152430	543	186311	485
148013	361	152431	543	186312	485
148016	361	152600	540	186330	485
148018	356	152601	540	186331	485
148019	359	152610	540	186332	485
148060	360	152611	540	186340	485
148070	233	152640	543	186341	485
148071	233	152641	543	186342	485
148091	359	152750	537	186350	485
148540	388	152751	537	186351	485
		152780	537	186352	485
149000		152781	537	186360	485
149381	305	152960	543	186361	485
149387	305	152961	543	186362	485
149388	305			186640	485
149452	381	153000		186641	485
149471	334	153130	536	186642	485
149511	334	153140	535		
149762	332	153141	535	210000	
149772	332	153420	537	210060	318, 878
		153421	537	210061	878
151000		153560	539	210064	878
151040	314	153561	539		
151041	314	153564	539	220000	
151049	314	153850	537	220000	879
151271	366	153851	537		
151275	366			227000	
151282	337	155000		227176	779
151320	362	155156	273	227195	768
151321	362	155180	427	227219	657
151410	367	155236	427	227220	657
151411	367	155373	269	227221	657
151450	367	155490	448	227410	694
151451	367				

227418	694	229961	812	232195	676, 677
227462	848	229965	812	232285	781
227505	689	229971	813	232294	682
227600	854	229975	813	232295	682
227604	854			232431	755
227680	857	230000		232435	752
227684	857	230030	759	232441	753
227922	667, 668	230034	759	232445	753
		230044	746	232461	752
228000		230045	746	232465	752
228100	667	230060	631, 661, 671, 685	232485	773
228110	667	230061	671	232491	773
228130	667	230063	671	232495	773
228332	849	230066	671	232497	773
228342	849	230069	671	232531	741
228412	839	230084	747	232535	741
228430	845	230085	747	232537	741
228434	845	230090	642	232905	771
228555	699	230355	779	232915	771
228560	699	230365	765		
228712	653, 665, 685	230435	660	233000	
228722	653, 665	230444	746	233094	811
228725	881	230445	746	233095	811
228730	881	230465	659	233104	785
228752	685	230655	747	233105	785
228753	613, 659	230657	747	233114	764
228754	633, 637			233115	764
228771	761	231000		233134	783
228775	761	231010	758	233135	783
228776	761	231012	758	233145	685
228925	665	231015	758	233165	685
228935	665	231035	696	233185	685
228945	665	231072	693	233214	764, 783, 785
228960	663	231205	743	233215	764, 783, 785
228965	663	231215	637	233245	809
		231225	637	233255	809
229000		231230	633, 637, 640, 641	233302	761
229020	646	231231	681	233427	642
229021	646	231233	648, 649, 655, 669, 673	233437	643
229022	646, 647	231235	649	233447	640
229062	827	231305	681	233457	640
229071	815	231315	780	233500	840
229072	815	231351	762	233520	840
229075	815	231355	762	233540	847
229081	815	231370	649	233570	698
229085	815	231371	649	233571	698
229090	697	231410	647	233580	698
229110	825	231411	647	233582	698
229162	668	231420	648	233601	823
229172	668	231440	649	233605	823
229200	847	231455	675	233615	823
229230	846	231457	675	233621	823
229234	847	231475	672	233625	823
229320	843	231505	685	233635	822
229324	843	231515	808	233639	822
229374	843	231525	703	233650	825
229381	839	231535	703	233660	825
229383	839	231541	801	233792	849
229410	641	231545	801		
229411	641	231585	778	234000	
229420	643	231595	672	234505	736
229421	643	231805	768	234515	735
229422	642, 643, 645, 662	231807	768	234525	737
229430	645	231815	675	234535	797
229431	645	231817	675		
229432	645	231960	692	461000	
229524	736	231961	692	461060	868
229525	736			464804	873
229531	735	232000			
229532	735	232045	777	631000	
229535	735	232055	799	631337	433
229551	797	232065	659	631339	433
229554	797	232075	659		
229555	797	232085	659	900000	
229564	737	232101	775	900011	697, 698
229565	737	232105	775		
229574	735	232115	633	955000	
229575	735	232119	633	955135	880
229664	775	232125	633		
229665	775	232135	678	961000	
229702	827	232145	678	961034	879
229740	695	232155	676	961037	878
229741	697	232165	676	961250	878
229931	817	232175	677	961270	878
229935	817	232185	677		

1000100		1000634	367	1000917	218
1000127	403	1000638	362	1000926	293
1000128	403	1000639	362	1000927	293
1000129	403	1000640	362	1000929	293
1000130	403	1000655	849	1000930	293
1000131	403	1000665	662	1000932	293
1000132	403	1000666	662	1000933	293
1000135	403	1000668	341	1000935	293
1000136	403	1000669	341	1000936	293
		1000670	341	1000957	297
		1000682	666		
1000300		1000683	666	1001000	
1000327	377	1000685	253	1001015	236
1000329	377	1000686	253	1001016	236
1000330	377	1000688	253	1001017	237
1000332	801	1000689	253	1001018	237
1000333	767	1000691	253	1001019	430
1000334	767	1000692	253	1001020	430
1000335	781	1000694	253		
1000336	779	1000695	253	1001100	
1000339	801			1001165	235
1000340	767	1000700		1001166	235
1000342	767	1000702	405	1001167	235
1000343	673	1000703	405	1001168	235
1000344	673	1000704	405	1001169	235
1000345	673	1000711	516	1001171	235
1000346	673	1000712	517	1001172	235
1000384	849	1000713	511		
1000398	659, 661	1000714	228	1001200	
		1000715	228	1001254	853
1000400		1000716	228	1001255	853
1000422	365	1000717	228	1001256	853
1000423	365	1000718	228	1001262	853
1000458	567	1000719	228	1001263	853
1000459	567	1000720	228	1001264	237
1000461	567	1000721	228	1001272	380
1000462	567	1000726	165	1001273	380
1000464	567	1000729	379	1001274	380
1000465	567	1000730	379	1001275	380
1000466	569, 571	1000735	699	1001276	380
1000468	569, 571	1000736	699	1001283	431
1000469	569, 571	1000763	448	1001284	431
1000473	569	1000773	296	1001286	431
1000474	569	1000777	339	1001287	431
1000476	569	1000780	339	1001299	341
1000477	569	1000783	274		
1000479	569	1000784	274	1001300	
1000480	569	1000785	274	1001300	341
1000487	569	1000786	274	1001303	341
1000489	569	1000797	780	1001304	341
1000497	573	1000799	684	1001309	293
1000498	573			1001310	293
		1000800		1001314	817
1000500		1000801	684	1001359	853
1000523	573	1000807	261		
1000524	573	1000808	261	1001400	
1000525	573	1000809	261, 306	1001400	291
1000533	573	1000810	261, 306	1001403	291
1000534	573	1000811	261, 306	1001406	291
1000535	575	1000812	261, 306	1001409	291
1000536	575	1000813	306	1001460	452
1000540	574	1000820	777	1001461	452
1000546	574	1000821	661	1001462	452
1000549	574	1000822	661	1001463	452
1000557	575	1000823	799	1001468	388
1000558	575	1000824	351	1001472	388
1000560	574	1000825	353	1001488	669
1000561	574	1000833	237	1001489	669
1000566	574	1000880	783	1001490	669
1000567	574	1000881	783	1001494	669
1000571	574	1000886	413		
1000574	239	1000887	413	1001500	
1000575	239	1000889	413	1001505	275
1000576	238	1000890	413	1001506	275
1000577	238	1000892	413	1001508	275
1000579	267, 297, 449	1000893	413	1001509	275
1000580	267, 297, 449	1000895	413	1001542	279, 281, 283, 295, 305, 307
		1000896	413	1001574	861
1000600				1001575	861
1000613	351	1000900			
1000614	353	1000909	880	1001700	
1000615	353	1000910	377	1001701	312
1000616	351	1000911	377	1001800	
1000618	351	1000914	218	1001861	521
1000621	353	1000915	218	1001868	513
1000623	353				

1001869	513	1002203	701	1002890	167
1001871	539	1002215	263, 408	1002891	167
1001872	539	1002216	263	1002893	841
1001900		1002218	868	1002895	841
1001901	170	1002221	869	1002897	841
1001902	170	1002228	335	1002898	841
1001903	170	1002229	335	1002899	841
1001905	171	1002238	357		
1001906	171	1002239	371	1002900	
1001907	171	1002240	371	1002900	721
1001930	234	1002400		1002902	721
1001931	234	1002402	745	1002903	807
1001939	272	1002403	745	1002904	807
1001950	153, 157, 161, 165	1002423	875	1002905	783
1001951	153, 157, 161, 165	1002424	875	1002906	631
1001952	153, 157, 161, 165	1002425	875	1002907	631
1001962	697	1002430	387	1002909	188
1001963	697	1002431	387	1002910	188
1001964	694	1002432	387	1002911	188
1001965	694	1002494	663	1002912	188
1001968	509	1002500		1002913	189
1001969	762	1002503	763	1002914	189
1001970	762	1002504	763	1002915	193
1001999	655	1002505	763	1002917	193
1002000		1002583	453, 601	1002918	193
1002000	655	1002591	221	1002919	193
1002001	655	1002592	221	1002922	243
1002002	777	1002594	221	1002925	373
1002003	257	1002600		1002927	373
1002004	255	1002602	482	1002928	363
1002005	255	1002603	482	1002929	363
1002006	255	1002604	482	1002931	379
1002008	257	1002607	387	1002933	379
1002010	255	1002608	387	1002934	261
1002011	255	1002686	535	1002936	261
1002012	255	1002690	491	1002937	305
1002013	255	1002691	868	1002939	305
1002015	255	1002692	868	1002940	426
1002018	765	1002693	868	1002941	426
1002020	423	1002694	491	1002948	311
1002021	423	1002695	491	1002949	311
1002022	423	1002696	491	1002950	311
1002023	405	1002697	485	1002951	310
1002024	405	1002698	485	1002952	760
1002025	405	1002699	485	1002953	760
1002029	411	1002700		1002954	760
1002030	411	1002700	485	1002955	760
1002032	739	1002701	485	1002956	679
1002033	739	1002702	485	1002957	679
1002034	739	1002703	485	1002958	679
1002035	773	1002704	485	1002959	679
1002045	315	1002705	485	1002962	329
1002046	315	1002791	872	1002964	329
1002069	759	1002800		1002965	261
1002070	759	1002842	363	1002967	272
1002075	425	1002843	363	1002968	272
1002076	425	1002844	363	1002969	401
1002077	425	1002845	497	1002970	401
1002098	244	1002853	723, 725, 727, 729, 730, 777	1002971	401
1002099	244	1002854	520	1002973	401
1002100		1002855	381	1002974	401
1002100	244	1002860	389	1002975	401
1002101	244	1002861	489	1002976	401
1002102	244	1002862	489	1002977	401
1002110	517	1002863	489	1002978	401
1002111	517	1002864	490	1002979	241
1002113	517	1002865	490	1002980	241
1002116	387	1002866	490	1002981	241
1002117	387	1002867	785	1002982	243
1002118	387	1002868	769	1002989	770
1002119	387	1002869	769	1002990	770
1002140	383	1002871	652	1002991	681
1002151	495	1002873	509	1002992	681
1002152	495	1002874	509	1003000	
1002153	495	1002875	509	1003001	683
1002163	279, 281, 283, 295	1002876	535	1003004	281
1002190	333	1002877	535	1003005	281
1002191	333	1002878	535	1003006	281
1002192	333	1002882	165	1003007	281
1002200		1002884	785	1003008	223
1002201	701			1003009	223
				1003010	223
				1003011	225
				1003012	225

1003013	225	1003508	339	1004737	591
1003014	419	1003518	811	1004738	376
1003015	419	1003519	811	1004739	376
1003016	419	1003530	290	1004740	370
1003017	417	1003532	290	1004741	370
1003018	417	1003535	651	1004742	370
1003019	417	1003536	650	1004743	370
1003029	448	1003537	651	1004744	281, 295, 309, 318
1003040	275	1003538	651	1004745	281, 295, 309
1003041	275	1003539	775	1004746	281, 295, 309
1003042	275			1004747	749
1003043	275	1004600		1004748	749
1003044	289	1004649	785	1004749	629
1003045	289	1004650	756	1004750	629
1003046	289	1004651	756	1004751	629
1003047	289	1004652	701	1004757	693
1003048	289	1004653	808	1004759	188
1003049	289	1004660	349	1004760	188
1003050	289	1004661	349	1004761	188
1003051	289	1004662	349	1004762	188
1003052	275	1004663	349	1004763	188
1003053	275	1004664	399	1004764	188
1003054	275	1004665	399	1004765	189
1003055	275	1004666	258	1004766	189
1003073	243	1004667	258	1004767	189
1003074	243	1004668	229	1004768	189
		1004669	229	1004769	194
1003100		1004670	355	1004770	194
1003104	870	1004671	355	1004771	194
1003105	871	1004674	295, 309	1004772	194
1003106	869	1004675	295, 309	1004773	296, 448
		1004676	295	1004774	267, 297, 449
1003300		1004677	797	1004775	267, 297, 449
1003316	369	1004678	757	1004780	875
1003317	369	1004679	757	1004781	876
		1004680	653	1004782	877
1003400		1004681	653	1004783	497
1003416	729	1004682	376	1004784	497
1003417	729	1004686	533	1004785	497
1003418	730	1004687	533		
1003419	730	1004688	533	1004800	
1003420	795	1004689	533	1004889	570
1003421	795	1004690	533	1004890	570
1003422	725	1004691	533	1004893	571
1003423	725	1004692	533	1004894	571
1003424	727	1004693	533	1004895	571
1003425	727	1004694	223	1004896	577
1003426	793	1004695	223	1004897	577
1003427	793	1004696	223	1004898	577
1003428	375	1004697	225	1004899	577
1003429	375	1004698	225		
1003430	375	1004699	225	1004900	
1003431	375			1004900	578
1003432	307	1004700		1004901	578
1003435	300	1004700	419	1004902	578
1003436	300	1004701	419	1004903	579
1003437	729	1004702	419	1004904	579
1003438	730	1004705	417	1004905	577
1003439	795	1004706	382	1004906	577
1003440	725	1004707	382	1004907	577
1003441	727	1004708	582	1004908	577
1003442	793	1004709	582	1004909	578
1003447	692	1004710	582	1004910	578
1003448	692	1004712	583	1004911	579
1003449	813	1004713	583	1004912	578
1003450	813	1004714	583	1004913	578
1003451	813	1004716	584	1004914	578
1003452	813	1004717	584	1004915	578
1003453	759	1004718	584	1004916	578
1003454	759	1004719	584	1004917	578
1003455	384	1004720	585	1004932	575
1003456	385	1004721	585	1004933	507
1003457	384	1004722	586	1004934	507
1003458	385	1004723	586	1004935	507
1003459	385	1004725	587	1004936	507
1003460	385	1004726	591	1004957	785
1003466	240	1004727	589	1004969	349
1003467	364	1004729	330	1004970	453
1003468	364	1004730	330	1004971	337
1003470	721	1004731	331		
1003479	792, 793, 795	1004732	359	1005000	
		1004733	356	1005075	862
1003500		1004734	591	1005076	862
1003506	339	1004735	591	1005077	862
1003507	339	1004736	591	1005078	862

1005079	862	1005315	862	1006195	874
1005080	862	1005316	862	1006196	874
1005081	862	1005317	864	1006197	874
1005082	862	1005318	864	1006198	875
1005083	862	1005381	869	1006199	874
1005085	420	1005387	873		
1005086	420	1005390	445	1006200	
1005087	421	1005391	445	1006202	873
1005088	421	1005392	445	1006268	719
1005089	814	1005394	445	1006270	719
1005090	814	1005395	288		
		1005396	288	1006300	
1005100		1005397	532	1006307	355
1005125	755	1005399	532	1006308	355
1005126	755			1006314	749
1005148	739	1005400		1006316	791
1005149	739	1005400	532	1006317	720
1005150	739	1005401	532	1006318	720
1005151	741	1005402	532	1006319	349, 720
1005153	741	1005407	217	1006321	861
1005154	741	1005408	217	1006326	691
1005155	741	1005410	217	1006327	792
1005156	741	1005415	217	1006328	723
1005157	741	1005416	217	1006329	723
1005177	188	1005418	217	1006336	870
1005178	189	1005423	217	1006343	445
		1005424	217	1006344	445
1005200		1005435	220	1006345	288
1005201	744	1005436	220	1006348	869
1005202	811	1005439	630	1006377	295
1005205	725, 727, 729, 730, 731, 793	1005440	630	1006378	295
1005206	725, 727, 729, 730, 731, 793	1005441	683	1006379	614, 615, 616, 617, 618, 619
1005207	725, 727, 729, 730, 731, 793	1005442	639	1006380	614, 615, 616, 617, 618, 619
1005214	318	1005443	751	1006381	614, 615, 616, 617, 618, 619
1005215	318	1005444	869	1006382	614, 615, 616, 617, 618, 619
1005216	318	1005445	869	1006383	616
1005217	318	1005446	171, 873	1006384	619
1005218	318			1006385	618
1005248	876	1006100		1006386	621
1005262	725, 727, 729, 730, 731	1006104	855	1006387	617
1005263	725, 727, 729, 730, 731	1006105	855	1006388	620
1005265	865	1006106	839	1006389	617
1005268	865	1006107	839	1006390	619
1005269	860	1006120	877	1006391	618
1005271	860	1006121	219	1006392	621
1005272	860	1006122	219	1006393	617
1005273	861	1006123	429	1006394	620
1005274	863	1006124	429	1006395	281
1005275	863	1006125	429	1006396	281
1005276	863	1006126	429	1006397	281
1005277	863	1006127	429	1006398	281
1005278	863	1006128	429	1006399	281
1005279	863	1006133	871		
1005280	863	1006134	872	1006400	
1005281	863	1006155	508	1006400	281
1005282	863	1006156	508	1006402	281
1005283	863	1006157	534	1006403	281
1005284	860	1006158	534	1006404	717
1005285	860	1006159	309, 508, 534	1006405	717
1005286	860	1006160	309, 508, 534	1006406	821
1005287	860	1006161	382	1006407	821
1005288	860	1006162	382	1006408	627
1005289	865	1006171	851	1006409	627
1005290	865	1006172	851	1006410	318
1005291	863	1006173	851	1006411	157
1005292	863	1006174	851	1006412	157
1005294	864	1006175	851	1006414	157
1005295	864	1006176	851	1006415	157
1005296	864	1006178	742	1006417	157
1005297	862	1006179	742	1006418	157
1005298	862	1006180	635	1006420	157
1005299	862	1006181	635	1006421	157
		1006182	635	1006423	395
1005300		1006183	743	1006424	395
1005301	864	1006184	637	1006425	397
1005302	864	1006185	191	1006426	397
1005303	864	1006186	191	1006427	397
1005305	865	1006187	191	1006428	397
1005307	865	1006188	191	1006429	397
1005308	865	1006189	191	1006430	397
1005310	865	1006190	191	1006431	285
1005311	861	1006191	691	1006432	285
1005312	861	1006192	691	1006433	285
1005313	863	1006193	691	1006434	285
1005314	863	1006194	874	1006435	285

1006436	285	1006633	475	1007250	870
1006437	285	1006634	475	1007251	870
1006438	285	1006635	475	1007252	870
1006439	397	1006636	475	1007253	870
1006440	397	1006639	477	1007254	871
1006441	347	1006640	477	1007255	871
1006442	347	1006641	477	1007256	871
1006443	347	1006642	477	1007257	871
1006444	347	1006645	477	1007270	876
1006445	505	1006646	477	1007271	208
1006446	505	1006647	477	1007272	208
1006449	285, 347, 395, 505	1006648	477	1007273	209
1006450	285, 347, 395, 505			1007274	209
1006451	285, 347, 395, 505	1007000		1007281	711
1006452	868	1007083	459, 463, 467	1007282	711
1006453	881	1007084	459, 463, 467	1007283	880
1006454	243, 874	1007090	207	1007284	150
1006455	875	1007091	207	1007285	150
1006456	873	1007092	207	1007286	152
		1007093	207	1007287	152
1006500		1007094	207	1007288	150
1006565	459, 463, 467	1007095	205	1007289	150
1006566	459, 463, 467	1007096	205	1007290	152
1006567	459, 463, 467	1007097	205	1007291	152
1006568	459, 463, 467	1007098	205	1007292	150
1006569	459, 463, 467	1007099	205	1007293	150
1006570	459, 463, 467			1007294	152
1006571	459, 463, 467	1007100		1007295	152
1006572	459, 463, 467	1007137	459, 463, 467	1007296	150
1006573	459, 463, 467	1007138	459, 463, 467	1007297	150
1006574	459, 463, 467	1007142	715	1007298	152
1006575	459	1007143	715	1007299	152
1006576	459	1007144	715		
1006577	459	1007145	715	1007300	
1006578	459	1007146	689	1007300	151
1006579	459	1007147	689	1007301	151
1006580	459	1007180	205	1007302	153
1006581	463	1007181	205	1007303	153
1006582	463	1007182	205	1007304	151
1006583	463	1007183	205	1007305	151
1006584	463	1007184	207	1007306	153
1006585	463	1007185	207	1007307	153
1006586	463	1007186	207	1007308	151
1006587	467	1007187	207	1007309	151
1006588	467	1007188	463, 467	1007310	153
1006589	467	1007189	463, 467	1007311	153
1006590	467	1007190	285, 347, 395, 505	1007312	151
1006591	467	1007191	207	1007313	151
1006592	467	1007192	205	1007314	153
1006593	459	1007193	205	1007315	153
1006594	459	1007194	207	1007316	161
1006595	463	1007195	831	1007317	161
1006596	463	1007196	831	1007318	161
1006597	467	1007197	831	1007319	161
1006598	467	1007198	831	1007320	161
1006599	459, 463, 467			1007321	161
		1007200		1007322	161
1006600		1007200	331	1007323	161
1006600	459, 463, 467	1007201	331	1007324	161
1006601	459, 463, 467	1007202	331	1007325	161
1006602	459, 463, 467	1007207	744	1007326	161
1006603	459, 463, 467	1007213	872	1007327	161
1006604	459, 463, 467	1007215	872	1007328	126
1006605	459, 463, 467	1007216	876	1007329	126
1006606	459, 463, 467	1007225	876	1007330	126
1006607	459, 463, 467	1007226	872	1007331	126
1006608	459, 463, 467	1007228	872	1007332	126
1006609	459, 463	1007229	873	1007333	126
1006610	467	1007230	861	1007334	126
1006611	459	1007231	861	1007335	126
1006612	459	1007232	614	1007336	126
1006613	459, 463, 467	1007233	614	1007337	126
1006614	459, 463, 467	1007234	615	1007338	126
1006615	473	1007235	615	1007339	126
1006616	473	1007236	714	1007340	126
1006617	473	1007237	613	1007341	126
1006618	473	1007238	835, 837	1007342	126
1006621	475	1007239	835, 837	1007343	126
1006622	475	1007240	835, 837	1007344	126
1006623	475	1007241	837	1007345	126
1006624	475	1007242	837	1007346	126
1006627	473	1007243	835	1007347	126
1006628	473	1007244	835	1007348	126
1006629	473	1007245	835	1007349	126
1006630	473	1007246	837	1007350	126

1007351	126	1007443	126	1007597	279, 505, 531
1007352	503	1007444	126	1007598	279
1007353	503	1007445	126	1007599	279
1007354	503	1007446	126		
1007355	529	1007447	126	1007600	
1007356	529	1007448	126	1007600	327
1007357	437, 597	1007449	126	1007601	327
1007358	437, 597	1007450	126	1007602	327
1007359	437, 597	1007451	126	1007603	327
1007360	437, 597	1007452	126	1007604	251
1007361	437, 597	1007453	126	1007605	251
1007362	437, 597	1007454	126	1007606	251
1007363	443	1007458	805	1007607	251
1007364	443	1007459	607	1007608	395
1007365	443	1007460	607	1007609	395
1007366	443	1007461	791	1007610	395
1007368	138	1007462	444	1007611	395
1007369	138	1007463	444	1007612	325
1007370	138	1007464	444	1007613	325
1007371	138	1007465	444	1007614	325
1007372	138	1007466	444	1007615	325
1007373	138	1007467	444	1007616	325
1007374	138	1007468	287	1007617	325
1007375	138	1007469	287	1007618	325
1007376	138	1007470	287	1007619	325
1007377	138	1007471	287	1007620	443
1007378	138	1007472	287	1007621	443
1007379	138	1007473	287	1007622	443
1007380	441, 601	1007488	126	1007623	443
1007381	124	1007489	126	1007624	139
1007382	124			1007625	139
1007383	124	1007500		1007626	139
1007384	124	1007511	805	1007627	139
1007385	134	1007512	609	1007628	139
1007386	134	1007513	609	1007629	139
1007387	134	1007521	178	1007630	126
1007388	134	1007522	178	1007631	126
1007389	134	1007523	178	1007632	126
1007390	134	1007524	178	1007633	126
1007391	134	1007525	178	1007634	126
1007392	134	1007526	178	1007635	126
1007393	134	1007527	178	1007636	126
1007394	134	1007528	178	1007637	126
1007395	134	1007529	178	1007638	501
1007396	134	1007530	178	1007639	501
1007397	134	1007531	178	1007640	501
1007398	134	1007532	178	1007641	503
1007399	134	1007533	178	1007642	503
		1007534	178	1007643	503
1007400		1007535	178	1007644	527
1007400	134	1007536	178	1007645	527
1007401	137	1007537	178	1007646	527
1007402	137	1007538	178	1007647	527
1007403	137	1007539	178	1007648	529
1007404	137	1007540	178	1007649	529
1007405	135	1007541	178	1007651	603
1007406	135	1007542	178	1007652	603
1007407	135	1007543	178	1007653	805
1007408	135	1007544	178	1007654	525
1007409	125	1007545	178	1007655	525
1007410	125	1007546	178	1007656	525
1007411	125	1007547	178	1007657	525
1007412	125	1007551	213	1007667	713
1007421	124	1007552	213	1007668	713
1007422	124	1007559	213	1007669	611
1007423	135	1007560	213	1007670	611
1007424	135	1007567	213	1007673	501
1007425	135	1007568	213	1007674	501
1007426	135	1007580	605	1007680	833
1007427	135	1007581	709	1007681	833
1007428	135	1007582	789	1007682	833
1007429	135	1007583	605	1007683	833
1007430	135	1007584	605	1007684	833
1007431	125	1007585	709	1007685	833
1007432	125	1007586	789	1007692	439, 599
1007433	136	1007587	605	1007693	439, 599
1007434	136	1007588	279	1007694	439, 599
1007435	136	1007589	279	1007695	439, 599
1007436	136	1007590	393	1007696	439, 599
1007437	136	1007591	393	1007697	439, 599
1007438	136	1007592	393		
1007439	137	1007593	393		
1007440	137	1007594	345		
1007441	137	1007595	345		
1007442	137	1007596	279, 505, 531		

SIGHT MOVE
1004690



1-PHASE

1-PHASE SURFACE-MOUNTED TRACK _____	495
1-PHASE SURFACE-MOUNTED TRACK ACCESSORIES _____	497
1-PHASE RECESSED TRACK _____	499
1-PHASE RECESSED TRACK ACCESSORIES _____	499

3-PHASE

EUTRAC® 3-PHASE SURFACE-MOUNTED TRACK _____	537
EUTRAC® 3-PHASE SURFACE-MOUNTED TRACK ACCESSORIES _____	539
EUTRAC® 3-PHASE RECESSED TRACK _____	541
EUTRAC® 3-PHASE RECESSED TRACK ACCESSORIES _____	541
S-TRACK 3-PHASE MOUNTING RAIL DALI _____	529
S-TRACK 3-PHASE MOUNTING RAIL DALI ACCESSORIES _____	530-531
S-TRACK 3-PHASE RECESSED TRACK DALI _____	533
S-TRACK 3-PHASE RECESSED TRACK DALI ACCESSORIES _____	535

48V SYSTEMS

48V TRACK MOUNTING TRACK DALI _____	457
48V TRACK MOUNTING TRACK DALI ACCESSORIES _____	459
48V TRACK MOUNTING TRACK DEEP DALI _____	461
48V TRACK MOUNTING TRACK DEEP DALI ACCESSORIES _____	463
48V TRACK RECESSED TRACK DALI _____	465
48V TRACK RECESSED TRACK DALI ACCESSORIES _____	467

A

ABRIDOR 100 POLE _____	681
ABRIDOR 60 POLE _____	681
ABRIDOR SENSOR WL _____	770
ABRIDOR WL _____	770

ACCESSORIES

CABLE CLAMP _____	878
CABLE EXTENSION _____	879
CEILING HOOK _____	878
CONNECTION BOX IP68, 5-PIN, DALI _____	881
CONTROLLER LED STIP CCT / RGBW _____	869
CONVERTER PHASE DIM -> DALI _____	868
DALI CONTROLLER 24V DC _____	869
DALI INTERFACE 1-10V + ON/OFF _____	868
DALI UNIVERSAL DIMMER 10-300W _____	869
DOUBLE-SIDED TAPE _____	879
GLENOS® CEILING ROSETTE _____	878
GU10 CONNECTION BOX WITH BASE, UNIVERSAL _____	880
GU10 LED CONNECTION BOX WITH BASE MAX. 10W _____	880
GU10 SOCKET _____	880
LED DRIVER 100W 24V DC DALI DIMMABLE INCLUDING STRAIN RELIEF _____	871
LED DRIVER 100W 24V DC INCLUDING STRAIN RELIEF _____	870
LED DRIVER 10W 200MA DIMMABLE INCLUDING STRAIN RELIEF _____	872
LED DRIVER 10W 250MA _____	875
LED DRIVER 12W 250MA DALI DIMMABLE WITH RF INTERFACE _____	874
LED DRIVER 150W 24V DC DALI DIMMABLE INCLUDING STRAIN RELIEF _____	871
LED DRIVER 150W 24V DC INCLUDING STRAIN RELIEF _____	870
LED DRIVER 20W 250-700MA 1-10V/ DALI DIMMABLE _____	875
LED DRIVER 20W 350MA DIMMABLE _____	872
LED DRIVER 20W 350MA _____	876
LED DRIVER 20W 350MA/500MA PHASE _____	872
LED DRIVER 20W 700MA DIMMABLE _____	873
LED DRIVER 21W 500MA INCLUDING STRAIN RELIEF _____	876
LED DRIVER 250W 24V DC DALI DIMMABLE INCLUDING STRAIN RELIEF _____	871
LED DRIVER 250W 24V DC INCLUDING STRAIN RELIEF _____	870
LED DRIVER 25W 150-300MA DALI DIMMABLE _____	873

LED DRIVER 25W 150-700MA DALI DIMMABLE _____	873
LED POWER SUPPLY 100W 24V 2 CHANNEL DALI DIMMABLE _____	872
LED POWER SUPPLY 100W 24V DC _____	871
LED POWER SUPPLY 15W 12V _____	869
LED POWER SUPPLY 15W 24V _____	869
LED POWER SUPPLY 20W 12/24V _____	869
LED POWER SUPPLY 25W 24V _____	870
LED POWER SUPPLY 50W 24V _____	870
LED POWER SUPPLY 60W DALI, 24V, 2 CHANNEL DALI DIMMABLE _____	871
WIRE ROPE SUSPENSION _____	878

ADEGAN FL, E27 _____	663
ADEGAN MANILA FL, E27 _____	663
ADI EL _____	822
AINOS CW _____	812
AINOS CW SENSOR _____	813
AINOS CW SENSOR, SQUARE _____	813
AINOS CW, SQUARE _____	813
AKALO D83 EL _____	237
ALPA CONE 100 POLE, E27 _____	665
ALPA MUSHROOM 45 POLE, E27 _____	665
ALPA MUSHROOM 75 POLE, E27 _____	665
ALTRA DICE CL, QPAR51 _____	263
ALTRA DICE CW, DOUBLE, QPAR51 _____	263, 408
ALTRA DICE TRACK 1-PHASE, QPAR51 _____	521
ALTRA DICE TRACK 3-PHASE, QPAR51 _____	556
ANDREAS WL, QT-DE12 _____	373
ANELA CL, PHASE _____	261
ANELA PD, PHASE _____	306
ANGOLUX SENSOR WL _____	762
ANGOLUX WL _____	762
APONI 120 POLE, PHASE _____	666
APONI 90 POLE, PHASE _____	666
ARLINA 130 WL _____	371
ARLINA 60 WL _____	371
ARROCK ARC POLE, QPAR51 _____	648
ARROCK GRANITE 40 POLE, SQUARE, E27 _____	647
ARROCK GRANITE 70 POLE, SQUARE, E27 _____	647
ARROCK SLOT POLE, QPAR51 _____	649
ARROCK STONE 50 POLE _____	649
ARROCK STONE 75 POLE _____	649
ASMARA LV, QR-C51 _____	486
ASSO 300 WL, PHASE _____	366, 367
ASTINA CL, QPAR51 _____	261
ASTINA PD, QPAR51 _____	305
ASTINA STEEL WL, QPAR51 _____	761
ASTINA UP/DOWN WL, QPAR51 _____	379
ASTINA WL, QPAR51 _____	761
ASTO CW, DOUBLE, QPAR51 _____	415
ASTO CW, QUAD, QPAR51 _____	415
ASTO CW, SINGLE, QPAR51 _____	415
ASTO CW, TRIPLE, QPAR51 _____	415
ASTO TUBE 1-PHASE, GU10 _____	505
ASTO TUBE CL, SINGLE, GU10 _____	395
ASTO TUBE CW, DOUBLE, GU10 _____	397
ASTO TUBE CW, QUADRUPLE, GU10 _____	397
ASTO TUBE CW, SINGLE, GU10 _____	397
ASTO TUBE CW, TRIPLE, GU10 _____	397
ASTO TUBE DECORATIVE REFLECTOR _____	285, 395, 505
ASTO TUBE PD, DOUBLE, GU 10 _____	285
ASTO TUBE PD, QUADRUPLE, GU 10 _____	285
ASTO TUBE PD, SINGLE, GU 10 _____	285
ASTO TUBE PD, TRIPLE, GU 10 _____	285
ASTO TUBE WL, SINGLE, GU10 _____	347
ASTO TUBE WL, UP/DOWN, GU10 _____	347
AVO CW, DOUBLE, QPAR51 _____	413
AVO CW, QUAD, QPAR51 _____	413
AVO CW, SINGLE, QPAR51 _____	413
AVO CW, TRIPLE, QPAR51 _____	413
AVO TRACK 1-PHASE, QPAR51 _____	515
AVO TRACK 3-PHASE, QPAR51 _____	561

B

BASKET WL, E27 _____	373
BATTEN 120 CW _____	429
BATTEN 60 CW _____	429
BENA 120 CW _____	433
BENA 150 CW _____	433
BIG NAILS 50 POLE, E27 _____	668
BIG NAILS 80 POLE, E27 _____	668

BIG NAUTILUS SP, ROUND, QPAR51 _____	694
BIG PLOT COVER, 2-PACK _____	853
BIG PLOT COVER, 4-PACK _____	853
BIG PLOT MODULES _____	853
BIG QUAD UP/DOWN WL _____	755
BIG QUAD WL _____	752, 755
BIG THEO CL _____	797
BIG THEO CL, QPAR111 _____	797
BIG THEO UP/DOWN WL, QPAR111 _____	735
BIG THEO WL _____	737
BIG THEO WL, QPAR111 _____	737
BIMA 1-PHASE, DOUBLE, QPAR51 _____	519
BIMA 1-PHASE, SINGLE, QPAR51 _____	519
BIMA 3-PHASE, DOUBLE, QPAR51 _____	559
BIMA 3-PHASE, SINGLE, QPAR51 _____	559
BOOKAT POLE _____	683
BOOKAT WL _____	751
BOX UP/DOWN WL, QT-DE12 _____	773
BOX-L WL _____	773
BOX-L WL, E27 _____	773
BRICK DOWNUNDER EL _____	827
BRICK DOWNUNDER EL, E14 _____	827
BRICK EL, ASYMMETRICAL _____	825
BRICK EL, SYMMETRICAL _____	825
BRICK MESH EL _____	825
BULAN CW, E14 _____	815
BULAN GRID CW, E27 _____	815

C

C-POL POLE, E27 _____	672
CARISO WL, PHASE _____	368
CHROMBO WL, PHASE _____	369
COMET LED LV _____	491
COMET LV, QR-C51 _____	491
CONCRETO EL, CUT _____	821
CONCRETO EL, WING _____	821
CONCRETO FL, SQUARE, QPAR51 _____	627
CONCRETO FL, ROUND, QPAR 51 _____	627
CONCRETO L WL _____	717
CONCRETO M WL _____	717
CONE FL, E27 _____	660
COSMIC LV, QR-C51 _____	487
COUPA FLEX WL _____	381
CUBIX FL, QPAR51 _____	660
CYFT CW _____	395

D

DASAR® 115 RL, SQUARE, QPAR51 _____	843
DASAR® 115 RL, RUND, QPAR51 _____	843
DASAR® 1200 EL _____	831
DASAR® 215 RL, SQUARE, QPAR111 _____	847
DASAR® 215 RL, ROUND, E27 _____	847
DASAR® 215 RL, ROUND, QPAR111 _____	846
DASAR® 255 EL _____	839
DASAR® 270 EL, ASYMMETRICAL _____	841
DASAR® 270 EL, SYMMETRICAL _____	841
DASAR® 370 EL, ROUND _____	847
DASAR® 600 EL _____	831
DASAR® 920 EL _____	840
DASAR® 920 SP, 230V _____	698
DASAR® EXACT 116 EL, SQUARE, QPAR51 _____	845
DASAR® EXACT 116 EL, ROUND, QPAR51 _____	845
DASAR® FLAT 120 EL _____	839
DASAR® FLAT 80 EL _____	839
DASAR® L RL, SQUARE _____	835
DASAR® L RL, ROUND _____	835
DASAR® PROJECTOR SP, 12/24V _____	698
DASAR® S RL, SQUARE _____	833
DASAR® S RL, ROUND _____	833
DASAR® XL RL, SQUARE _____	837
DASAR® XL RL, ROUND _____	837
DEKLED EL _____	234
DELWA WL _____	767
DENA 30 WL, E14 _____	373
DIO FLEX PLATE WL _____	387
DIO FLEX PLATE WL QPAR51 _____	387
DIRETO 60 WL, PHASE _____	370
DIRETO 90 WL, PHASE _____	370
DISPLAY ADL 50 QPAR51 _____	389
DL 126 EL _____	227
DORISA 30 WL _____	339
DORISA 50 WL _____	339
DOWNUNDER OUT L EL _____	823
DOWNUNDER OUT M EL _____	823

DOWNUNDER OUT S EL	823
DOWNUNDER OUT WL, SQUARE	769
DOWNUNDER OUT WL, ROUND	769
DOWNUNDER PUR 150 EL	242
DOWNUNDER PUR 80 EL	242
DURNO LV	489

E

ENOLA B CL, QPAR51	259
ENOLA B CW, DOUBLE, QPAR51	407
ENOLA B CW, SINGLE, QPAR51	407
ENOLA B PD, QPAR51	305, 517
ENOLA B TRACK 1-PHASE, QPAR51	517
ENOLA B WL, QPAR51	379
ENOLA C CL	259
ENOLA C TRACK 1-PHASE	517
ENOLA C TRACK 1-PHASE	516
ENOLA C TRACK 3-PHASE	561
ENOLA M ASYMMETRICAL LENS	731
ENOLA M LENS 19°	731
ENOLA OCULUS CL	792
ENOLA OCULUS WL, SINGLE	723
ENOLA OCULUS WL, UP/DOWN	723
ENOLA PD, E27	305
ENOLA ROUND L CL	793
ENOLA ROUND L WL, SINGLE	725
ENOLA ROUND M CL	793
ENOLA ROUND M WL, SINGLE	725
ENOLA ROUND S CL	793
ENOLA ROUND S WL, SINGLE	725
ENOLA S, M, L REFLECTOR, 56°	731
ENOLA SQUARE L CL	795
ENOLA SQUARE L WL, SINGLE	729
ENOLA SQUARE M CL	795
ENOLA SQUARE M WL, SINGLE	729
ENOLA SQUARE S CL	795
ENOLA SQUARE S WL, SINGLE	729
ESKINA 30 POLE	631
ESKINA 80 POLE	631
ESKINA D DISPLAY, PHASE	783
ESKINA FRAME 125 POLE, DOUBLE	630
ESKINA FRAME 175 POLE, DOUBLE	630
ESKINA FRAME 45 POLE, SINGLE	629
ESKINA FRAME 75 POLE, DOUBLE	629
ESKINA FRAME 75 POLE, SINGLE	629
ESKINA FRAME CL, SINGLE	791
ESKINA FRAME WL	749
ESKINA FRAME WL, DOUBLE	749
ESKINA SPOT CW, PHASE	807
ESKINA SPOT SENSOR CW, PHASE	807
EURO CUBE 3-PHASE	555
EURO SPOT TRACK 1-PHASE, QPAR51	521
EURO SPOT TRACK 3-PHASE, QPAR111	555
EURO SPOT TRACK 3-PHASE, QPAR51	555

F

F-POL POLE, E27	672
F-POL WL, E27	778
FENDA 15 CM, ROUND	448
FENDA 30 CM, ROUND	449
FENDA BOW BASIS FL, E27	448
FENDA FL, E27	447, 448
FENDA Ø 45 CM, ROUND	449
FENDA Ø 70 CM, ROUND	449
FENDA PD, E27	296
FENDA TL, E27	447
FERA 25 CL	272
FERA 25 CL, DALI	272
FITU CUBE WL, E27	376
FITU PD, E27	295
FLAC BEAM® SP	693
FLATT 100 POLE	679
FLATT 65 POLE	679
FLATT SENSOR WL	760
FLATT WL	760
FLOODI L SP	691
FLOODI M SP	691
FLOODI S SP	691
FORCHINI 50 PD, E27	312
FORCHINI 70 PD, E27	312
FORCHINI M 40 PD, E27	313
FORCHINI M 40 TRACK 1-PHASE, E27	512
FORCHINI M 40 TRACK 3-PHASE, PD, E27	554

FORCHINI M 50 PD, E27	313
FRAME BASIC	238
FRAME BASIC RL, HV	238
FRAME BASIC SET RL	238
FRAME CURVE EL	239

G

GALEN 120 SP	692
GALEN 60 SP	692
GIMBLE OUT EL	849
GLENOS® 60 WL	339
GLENOS® PD, 1M, 1-10V	291
GLENOS® PD, 2M, 1-10V	291
GLOO PURE 27 POLE, E27	655
GLOO PURE 44 POLE, E27	655
GLOO PURE 70 POLE, E27	655
GLOO PURE WL, E27	777
GRAFIT 30 POLE, E27	637
GRAFIT 30 POLE, ROUND, E27	635
GRAFIT 60 POLE, E27	637
GRAFIT 60 POLE, ROUND, E27	635
GRAFIT 90 POLE, E27	637
GRAFIT 90 POLE, ROUND, E27	635
GRAFIT WL, E27	743
GRAFIT WL, SQUARE, SENSOR, E27	743
GRAFIT WL, ROUND, E27	742
GRAFIT WL, ROUND, SENSOR, E27	742
GRAZIA FLEXSTRIP LED 24V	582
GRAZIA IP FLEXSTRIP 24V	591
GRAZIA IP FLEXSTRIP RGBW, 24V	591
GRAZIA IP FLEXSTRIP	
TUNABLE WHITE, 24V	591
GRAZIA PRO FLEXSTRIP 24V	583, 584
GRAZIA PRO FLEXSTRIP RGBW, 24V	589
GRAZIA PRO FLEXSTRIP	
TUNABLE WHITE, 24V	587
GRAZIA PRO MAX FLEXSTRIP 24V	585, 586
GRAZIA 10 SURFACE-MOUNTED	
PROFILE 2M	567
GRAZIA 10 SURFACE-MOUNTED	
PROFILE, STANDARD	567
GRAZIA 10 ACCESSORIES	569
GRAZIA 10 EDGE 2 M	570
GRAZIA 10 RECESSED PROFILE	567
GRAZIA 10 EDGE ACCESSORIES	571
GRAZIA 20 SURFACE-MOUNTED	
PROFILE, FLAT, 3M	573
GRAZIA 20 SURFACE-MOUNTED	
PROFILE, STANDARD, 3M	573
GRAZIA 20 RECESSED PROFILE 3M	573
GRAZIA 20 ACCESSORIES	574, 575
GRAZIA 60 SURFACE-MOUNTED PROFILE	577
GRAZIA 60 RECESSED PROFILE	577
GRAZIA 60 ACCESSORIES	578, 579

H

H-POL 30 POLE	676
H-POL 60 POLE	676
H-POL TWIN 30 POLE	677
H-POL TWIN 60 POLE	677
HELIA 30 PD	301
HELIA 30 PD, PHASE	301
HELIA 40 PD	303
HELIA 40 PD, PHASE	303
HELIA 50 TRACK 1-PHASE	507
HELIA 50 TRACK 3-PHASE	561
HELIA AMBIENT 35 PD	300
HELIA AMBIENT 35 PD, PHASE	300
HELIA CW, DOUBLE, PHASE	809
HELIA CW, SINGLE, PHASE	809
HELIA SPOT L SP, SINGLE, PHASE	699
HELIA SPOT S SP, SINGLE	699
HORN DL, DOUBLE, QPAR51	219
HORN DL, SINGLE, QPAR51	219, 220
HORN EL, SINGLE, QPAR51	220
HORN MAGNA EL	221
HORN MINI EL	218
HORN-T EL, QPAR111	221

I

I-PENDANT PRO PD, 1195X295MM, DALI	289
I-RING POLE	613
I-RING WL	714

IMPERVA 120 CW	817
IN-LINE 22 48V,	
DARKLIGHT REFLECTOR, DALI	473
IN-LINE 22 48V, OPAL, DALI	473
IN-LINE 24 48V, MOVE, OPAL, DALI	477
IN-LINE 44 48V, DARKLIGHT REFLECTOR, DALI	475
IN-LINE 44 48V, OPAL, DALI	475
IN-LINE 46 48V, MOVE,	
DARKLIGHT REFLECTOR, DALI	477
INDA CW, QPAR51	409
IPERI 50 POLE	681
IPERI WL	780

K

KADUX DL, DOUBLE, PHASE	213
KADUX DL, SINGLE, PHASE	213
KADUX DL, TRIPLE, PHASE	213
KADUX EL, DOUBLE, QPAR111	215
KADUX EL, DOUBLE, QPAR51	214
KADUX EL, SINGLE, QPAR111	215
KADUX EL, SINGLE, QPAR51	214
KADUX EL, TRIPLE, QPAR51	214
KALU CW, DOUBLE, PHASE	403
KALU CW, DOUBLE, QPAR111	405
KALU CW, QUAD, PHASE	403
KALU CW, QUAD, QPAR111	405
KALU CW, SINGLE, PHASE	403
KALU CW, SINGLE, QPAR111	405
KALU CW, TRIPLE, PHASE	403
KALU CW, TRIPLE, QPAR111	405
KALU TRACK 1-PHASE, PHASE	520
KALU TRACK 1-PHASE, QPAR111	520
KALU TRACK 3-PHASE, QPAR111	558
KALU TRACK LED 3-PHASE, PHASE	558
KARPO 30 CW, SINGLE	399
KARPO 30 EL	232
KARPO 30 WL, SINGLE	383
KARPO FL	452
KARPO GOOSE WL	382
KARPO MAGN CW, SINGLE, PHASE	382
KARPO TL	452
KARPO WL	383
KENKUA SPOT WL, E27	381
KERAS ELT WL, E27	779
KINI EL, PHASE	237

L

L-LINE 120 WL	341
L-LINE 60 WL	341
L-LINE OUT 30 FL, VERTICAL	650
L-LINE OUT 50 POLE, HORIZONTAL	651
L-LINE OUT 60 FL, VERTICAL	651
L-LINE OUT 80 POLE, HORIZONTAL	651
L-LINE OUT WL	775
LALU® CONE 15 LAMP SHADE	178
LALU® ELYPSE 15 LAMP SHADE	178
LALU® ELYPSE 22 LAMP SHADE	178
LALU® ELYPSE 33 LAMP SHADE	178
LALU® PD, E27	183
LALU® PD, LED BASE, PHASE	177
LALU® PD, LED BASE, PHASE, RECESSED	177
LALU® PLATE 15 LAMP SHADE	178
LALU® PLATE 22 LAMP SHADE	178
LALU® SHADE, E27 BASE	183
LALU® TETRA 14 LAMP SHADE	178
LALU® TETRA 24 LAMP SHADE	178
LALU® TETRA 36 LAMP SHADE	178

LAMPS

LED A60 E27	864
LED A60 E27	864
LED A60 E27	864
LED A60 E27, MIRRORHEAD, CHROM	865
LED A60 E27, RGBW, SMART	864
LED A60 E27, TUNABLE 2700-6500K, SMART	864
LED C35 E14	860
LED C35 E14	860
LED G125 E27	865
LED GU10	862
LED GU10	862
LED GU10	862

LED QPAR 111 GU10	863	M-POL S POLEHEAD, DALI	617	NEW TRIA® 68 DL, SQUARE, QPAR51	138
LED QPAR 111 GU10	863	M-POL S POLEHEAD, LOUVER	618	NEW TRIA® 68 DL, ROUND, DTW, PHASE	135
LED QPAR 111 GU10	863	M-POL S POLEHEAD, LOUVER, DALI	618	NEW TRIA® 68 DL, ROUND, PHASE	134, 135
LED QPAR111 GU10	862	M-POL S POLEHEAD, SHADER	617	NEW TRIA® 68 DL, ROUND, QPAR51	138
LED QPAR111 GU10	863	M-POL S POLEHEAD, SHADER, DALI	617	NEW TRIA® 75 DL, SQUARE, QPAR51	138
LED QPAR111 GU10	863	MAGANDA TL	453	NEW TRIA® 75 DL, ROUND, PHASE	137
LED QPAR111 GU10	864	MAGANDA WL	337	NEW TRIA® 75 DL, ROUND, QPAR51	138
LED QPAR51 GU10	861	MANA BASE WL, ROUND, PHASE	720	NEW TRIA® 75 XL DL, SQUARE, QPAR51	139
LED QPAR51 GU10	862	MANA OUT WL, PHASE	721	NEW TRIA® 75 XL DL, ROUND, QPAR51	139
LED QPAR51 GU10, RGBW, SMART	861	MANA OUT WL, SET	721	NEW TRIA® UNIVERSAL 68 DL, SQUARE,	
LED QPAR51 GU10, TUNABLE 2700-6500K,		MARONA CL, PHASE	273	PHASE	136,137
SMART	861	MARYLIN 40/60/90 WL	333	NEW TRIA® UNIVERSAL 68 DL, ROUND,	
LED QR51 GU5.3	861	MEDO® 30 CW, PHASE	161	PHASE	136,137
LED QT14 G9	860	MEDO® 30 EL, MOUNTING FRAME	171	NOBLO® CW, DOUBLE, PHASE	401
LED QT-DE12 R7S, 118 MM	860	MEDO® 30 EL, FRAMELESS	170	NOBLO® CW, SINGLE, PHASE	401
LED QT-DE12 R7S, 78 MM	860	MEDO® 40 CW, PHASE	161	NOBLO® CW, TRIPLE, PHASE	401
LED ST58 E27	865	MEDO® 40 EL, MOUNTING FRAME	171	NOBLO® SPOT LV, ROPE TRACK	491
LED ST64 E27	865	MEDO® 40 EL, FRAMELESS	170	NOBLO® SPOT 1-PHASE, PHASE	501, 503
LED T32 GU10	861	MEDO® 60 CL, SQUARE, 1-10V	165	NOBLO® SPOT 1-PHASE,	
LED T38 E27	865	MEDO® 60 CL, SQUARE, DALI	165	TRIPLE TRACK SET	501
LED T45 E27	865	MEDO® 60 CW, PHASE	161	NOBLO® SPOT 3-PHASE, PHASE	545, 547
LED TCR-TSE GX53	860	MEDO® 60 EL, MOUNTING FRAME	171	NOTAPO L RL	241
QPAR111 GU10, RGBW, SMART	862	MEDO® 60 EL, FRAMELESS	170	NOTAPO S RL	241
QPAR111 GU10, RGBW, SMART	862	MEDO® 90 CL, PHASE	161	NOYA PD, PHASE	290
QPAR111 GU10, TUNABLE 2700-6500K,		MEDO® PRO 30 CW, DALI	152	NUMINOS® 3 PH.	110-113
SMART	863	MEDO® PRO 30 CW, DALI, UGR<19	150	NUMINOS® CL	103-105
		MEDO® PRO 30 CW, DALI, UGR<19, DC	157	NUMINOS® CW	99-101
		MEDO® PRO 30 CW, PHASE	152	NUMINOS® DL	83-85
LED PANEL 620X620MM	243	MEDO® PRO 30 CW, PHASE, UGR<19	150	NUMINOS® GIMBLE DL	88-89
LED SPIKE SP	701	MEDO® PRO 40 CW, DALI	152	NUMINOS® MOVE DL	86-87
LED SPOT SP	785	MEDO® PRO 40 CW, DALI, UGR<19	150	NUMINOS® PD	106-109
LID I 45 POLE, SINGLE	611	MEDO® PRO 40 CW, DALI, UGR<19, DC	157	NUMINOS® PROJECTOR DL	91-93
LID I 75 POLE, DOUBLE	611	MEDO® PRO 40 CW, PHASE	152	NUMINOS® S PENDANT LIGHT 48V, DALI	471
LID I WL, DOUBLE	713	MEDO® PRO 40 CW, PHASE, UGR<19	150	NUMINOS® S SPOT 48V, DALI	469
LID I WL, SINGLE	713	MEDO® PRO 60 CW, DALI	153	NUMINOS® XS PENDANT LIGHT 48V, DALI	471
LID II WL	711	MEDO® PRO 60 CW, DALI, UGR<19	151	NUMINOS® XS SPOT 48V, DALI	469
LID II WL, UP/DOWN	711	MEDO® PRO 60 CW, DALI, UGR<19, DC	157	NUMINOS® ZOOM 3-PHASE	
LIGHT EYE® 150 1-PHASE, PD,		MEDO® PRO 60 CW, PHASE	153	TRACK SYSTEM	115
QPAR111	511	MEDO® PRO 60 CW, PHASE, UGR<19	151	NUMINOS® ACCESSORIES	94-95
LIGHT EYE® 150 PD, QPAR111	314	MEDO® PRO 90 CL, DALI	153		
LIGHT EYE® 90 1-PHASE, QPAR51	511	MEDO® PRO 90 CL, DALI, UGR<19	151	O	
LIGHT EYE® 90 PD, GU10	314	MEDO® PRO 90 CL, DALI, UGR<19, DC	157	OCCULDAS 13 CL, INDIRECT, PHASE	262
LIPSY® 30 CW, DOME	423	MEDO® PRO 90 CL, PHASE	153	OCCULDAS 23 CL, INDIRECT, PHASE	262
LIPSY® 30 CW, DRUM	425	MEDO® PRO 90 CL, PHASE, UGR<19	151	OCCULUS CL, MOVE, PHASE	229
LIPSY® 40 CW, DOME	423	MEDO® RING 60 PD, 1-10V	167	OCCULUS CL, PHASE	258
LIPSY® 40 CW, DRUM	425	MEDO® RING 60 PD, DALI	167	OCCULUS CW, PHASE	399
LIPSY® 40 CW, DRUM, DALI	426	MEDO® RING 90 PD, 1-10V	167	OCCULUS PD, SINGLE, PHASE	294
LIPSY® 50 CW, DOME	423	MELAN CW, E27	427	OCCULUS UP/DOWN WL, PHASE	355
LIPSY® 50 CW, DRUM	425	MERADO FLOOD WL, PHASE	388	OCCULUS WL, SINGLE, PHASE	355
LIPSY® 50 CW, DRUM, DALI	426	MERIDIAN BOX SENSOR WL, E27	747	ONE® 40 CW, DALI	193
LISENNE 40 POLE, E27	662	MERIDIAN BOX WL, E27	746, 747	ONE® 60 CW, DALI	193
LISENNE 70 POLE, E27	662	MERIDIAN WL, E27	746	ONE® 60 PD, DALI	188
LISENNE PD, E27	306	MIBO UP/DOWN WL, QT14	337	ONE® 60 PD, UP/DOWN, DALI	188
LISENNE WL, E27	375	MILANDOS 4 DL	217	ONE® 60 PD, UP/DOWN, PHASE	188
LITTLE SUN TL	443	MILANDOS 6 DL	217	ONE® 80 PD, DALI	188
LOGS 40 POLE	633	MILANDOS 8 DL	217	ONE® 80 PD, UP/DOWN, DALI	188
LOGS 70 POLE	633	MOBALA EL	243	ONE® BOW FL, UP/DOWN	197
LOGS IN L WL, PHASE	363	MOLAT CL, E27	799	ONE® CUBE PD, DALI	189
LOGS IN WL	362	MOLAT PD, E27	661	ONE® CUBE PD, UP/DOWN, DALI	189
LOGS IN WL, PHASE	362	MOLAT POLE, E27	661	ONE® DOUBLE PD, UP/DOWN, DALI	189
LOGS WL	775	MOLAT WL, E27	777	ONE® DOUBLE PD, UP/DOWN, PHASE	189
LONG GRILL CW	430	MYRA CW, SINGLE, QPAR51	785	ONE® LINEAR 100 PD, UP/DOWN, PHASE	191
LYGANT WL, DOUBLE	325	MYRA DISPLAY WL, CURVED, QPAR51	783	ONE® LINEAR 140 PD, UP/DOWN, PHASE	191
LYGANT WL, SINGLE	325	MYRA SPOT DOUBLE, GU10	685	ONE® STRAIGHT FL, UP/DOWN	196
		MYRA UP/DOWN WL, QPAR51	764	ONE® TRIPLE PD, DALI	189
		MYRA WL, DOUBLE, QPAR51	811	ORDI SENSOR WL	771
		NAGY 75 CL, QPAR51	261	ORDI WL	771
M				OSSA 180 WL, QT-DE12	367
M-POL 30 POLE	623	N		OSSA 300 WL, QT-DE12	367
M-POL 60 POLE	623	NAUTILUS 10 SP, SQUARE	696	OTOS GLAS POLE, E27	659
M-POL 90 POLE	623	NAUTILUS 10 SP, ROUND, QPAR51	694, 695	OUT-BEAM FRAME SP	811
M-POL M POLEHEAD	619	NAUTILUS 10 SPOT LED SP	697	OVAL 14 WL, UP/DOWN	715
M-POL M POLEHEAD, DALI	619	NAUTILUS 10 SPOT SP, QPAR51	697	OVAL 18 WL, UP/DOWN	715
M-POL M POLEHEAD, LOUVER	621	NAUTILUS SP, QR-C51	697	OVALISK 100 POLE	653
M-POL M POLEHEAD, LOUVER, DALI	621	NAUTILUS WL QPAR51	785	OVALISK 75 POLE	653
M-POL M POLEHEAD, SHADER	620	NEW TRIA® 150 DL, SQUARE, QPAR111	145	OVALISK CL	797
M-POL M POLEHEAD, SHADER, DALI	620	NEW TRIA® 150 DL, ROUND, QPAR111	145	OVALISK SENSOR WL	757
M-POL S POLEHEAD	616	NEW TRIA® 155 DL, DOUBLE	141	OVALISK WL	757
M-POL S POLEHEAD 180°,		NEW TRIA® 155 DL, DOUBLE, QPAR51	145		
GLARE REDUCTION	615	NEW TRIA® 300 DL, DOUBLE, QPAR111	145	P	
M-POL S POLEHEAD 180°,		NEW TRIA® 45 DL, ROUND	141	PANEL CL, 1200X300MM, DALI	275
GLARE REDUCTION, DALI	615	NEW TRIA® 68 DL, SQUARE, DTW, PHASE	135	PANEL CL, 1200X300MM, PHASE	275
M-POL S POLEHEAD 360°,		NEW TRIA® 68 DL, SQUARE, PHASE	134	PANEL TRACK 1-PHASE, SQUARE	507
GLARE REDUCTION	614				
M-POL S POLEHEAD 360°,					
GLARE REDUCTION, DALI	614				

PANEL TRACK 1-PHASE, ROUND	507
PANTILO 20 PD, E27	281
PANTILO 28 PD, E27	281
PANTILO CONVEX 29 PD, E27	283
PANTILO CONVEX 40 PD, E27	283
PANTILO OVAL PD, E27	281
PANTILO ROPE 19 CW, E27	393
PANTILO ROPE 19 PD, E27	279, 505, 549
PANTILO ROPE 20 PD, E27	279
PANTILO ROPE 27 CW, E27	393
PANTILO ROPE 27 PD, E27	279
PANTILO ROPE WL, G9	345
PARA 380 PD, E27	319
PARA CONE 14 1-PHASE, PD, QPAR51	509
PARA CONE 14 1-PHASE, QPAR51	509
PARA CONE 14 3-PHASE, PD, QPAR51	553
PARA CONE 14 3-PHASE, QPAR51	553
PARA CONE 20 PD, E27	309
PARA CONE 30 PD, E27	309
PARA CONE GL 1-PHASE, GU10	508
PARA CONE GL 3-PHASE, GU10	552
PARA CONE GL PD, GU10	309, 508, 552
PARA DOME PD, E27	318
PARA DOME SHADE	318
PATTA-I EL, ROUND, PHASE	244, 245
PATTA-I EL, SQUARE, PHASE	244, 245
PATTA-F EL, ROUND, PHASE	246
PATTA-F EL, SQUARE, PHASE	247
PEMA® WL	758, 759
PEMA® WL, E27	759
PHELIA 10 PD, E27	310
PHELIA 20 PD, E27	311
PHELIA 25 PD, E27	311
PHELIA 30 PD, E27	311
PHELIA FL, E27	453
PHELIA WL, QPAR51	388
PHOTONI 45 POLE, E27	605
PHOTONI 75 POLE, E27	605
PHOTONI CL, E27	789
PHOTONI WL, E27	709
PHOTONIA CL, E27	799
PHOTONIA PD, E27	659
PHOTONIA POLE, E27	659
PHOTONIA WL, E27	777
PLASTRA 101 WL, E14	361
PLASTRA 104 CL, E27	271
PLASTRA 104 WL, QT14	361
PLASTRA 105 CL, E27	271
PLASTRA CL, PHASE	271
PLASTRA CL, QPAR51	270
PLASTRA WL, CUBE, QT14	356
PLASTRA WL, CUBES	356
PLASTRA WL, CURVE, QT-DE12	361
PLASTRA WL, E14	357
PLASTRA WL, QPAR51	360
PLYTTA LV	490
POWER TRAIL-LITE® EL, SQUARE	849
POWER TRAIL-LITE® EL, ROUND	849
PURI CW, DOUBLE, QPAR51	411
PURI CW, QUAD, QPAR51	411
PURI CW, SINGLE, QPAR51	411
PURI CW, TRIPLE, QPAR51	411
PURI TRACK 1-PHASE, QPAR51	513
PURI TRACK 1-PHASE, TRIPLE TRACK SET	513
PURI TRACK 3-PHASE, QPAR51	557
PURI TRACK GLASS 3-PHASE, QPAR51	557
PURIA TRACK 1-PHASE, QPAR51	515

Q	
Q-LINE® CL, 1M, BAP, PHASE	253
Q-LINE® CL, 2M, BAP, PHASE	253
Q-LINE® PD, 1M, BAP, PHASE	293
Q-LINE® PD, 2M, BAP, PHASE	293
Q-LINE® PD, DALI, SINGLE	293
Q-LINE® WL	341
QUAD FRAME 14 WL	364
QUAD FRAME 19 WL	364
QUAD FRAME 9 WL	240
QUAD POLE	683
QUAD UP/DOWN 15 WL	753
QUAD WL	752
QUADRASS PD, E27	307
QUADRASS SPOT WL, E27	375
QUADRASS WL, E27	375
QUADRASYL 75 POLE, TCR-TSE	682

QUADRASYL WL, TCR-TSE	781
QUADRULO CL	811
QUADRULO FL	639
QUADRULO SENSOR WL, E27	745
QUADRULO WL	744
QUADRULO WL, E27	745

R	
R-CUBE 35 POLE	609
R-CUBE 75 POLE	609
R-CUBE CW	805
RASCALI 45 POLE	684
RASCALI 65 POLE	684
RASCALI WL	780
ROCCI 200 EL, SQUARE	855
ROCCI 200 EL, ROUND	855
ROCCI EL, SQUARE	854
ROCCI EL, ROUND	854
ROTOBALL 25 FL, E27	657
ROTOBALL 25 PD, E27	317
ROTOBALL 40 FL, E27	657
ROTOBALL 40 PD, E27	317
ROTOBALL 50 FL, E27	657
ROTOBALL 50 PD, E27	317
ROX ACRYL 30 POLE, E27	669
ROX ACRYL 60 POLE, E27	669
ROX ACRYL 90 POLE, E27	669
ROX CL, GX53	801
ROX CL, QPAR111	801
ROX UP/DOWN WL, QPAR111	767
ROX WL, QPAR111	767
RUBA CW	814
RUSTY® 40 POLE	642
RUSTY® 40 POLE, E27	643, 646
RUSTY® 70 POLE	643
RUSTY® 70 POLE, E27	643, 646
RUSTY® CONE 24 FL, E14	645
RUSTY® CONE 40 POLE, E27	645
RUSTY® CONE 70 POLE, E27	645
RUSTY® MANA SHADE, SQUARE	720
RUSTY® MANA SHADE, ROUND	720
RUSTY® PATHLIGHT POLE, TCR-TSE	642
RUSTY® SLOT 50 POLE	640
RUSTY® SLOT 50 POLE, E27	641
RUSTY® SLOT 80 POLE	640
RUSTY® SLOT 80 POLE, E27	641
RUSTY® UP/DOWN WL, SQUARE	756
RUSTY® UP/DOWN WL, ROUND	756

S	
S-CUBE 35 POLE	607
S-CUBE 75 POLE	607
S-CUBE CL	791
S-CUBE CW	805
S-TUBE 32 POLE, GU10	603
S-TUBE 75 POLE, GU10	603
S-TUBE CW	805
SALLUNA LV, QR-C51	489
SAMRINA SP, SINGLE, GU10	693
SEDO 14 WL	329
SEDO 21 WL	329
SEDO 7 WL	329
SHELL 15 WL, PHASE	365
SHELL 30 WL, PHASE	365
SIGHT 115 CW	431
SIGHT 60 CW	431
SIGHT MOVE 3-PHASE	551
SIGHT MOVE 3-PHASE, DALI	551
SIGHT TRACK 3-PHASE	550
SIGHT TRACK 3-PHASE, DALI	550
SITRA 360 CW, TCR-TSE	808
SITRA 360 POLE, TCR-TSE	685
SITRA 360 SPIKE SP, DOUBLE, TCR-TSE	703
SITRA 360 SPIKE SP, SINGLE, TCR-TSE	703
SITRA CL, TCR-TSE	801
SITRA CUBE WL, TCR-TSE	741
SITRA L WL, UP/DOWN, SQUARE	741
SITRA M WL, UP/DOWN, SQUARE	741
SITRA S WL, SINGLE, SQUARE	739
SITRA UP/DOWN WL	765
SITRA UP/DOWN WL, TCR-TSE	765
SITRA WL, TCR-TSE	779
SLOTBOX 40 POLE	678
SLOTBOX 70 POLE	678
SLOTS 45 POLE	675

SLOTS 65 POLE	675
SLOTS WL	768
SMALL PLOT COVER, 2-PACK	851
SMALL PLOT COVER, 4-PACK	851
SMALL PLOT MODULES	851
SOLASTO EL, SQUARE	857
SOLASTO EL, ROUND	857
SOLID CUBE WL, QT14	377
SOPRANA CL, E27	269
SPOT 79 CW, QPAR51	409
SQUARE POLE 30 POLE, E27	673
SQUARE POLE 60 POLE, E27	673
SQUARE POLE 90 POLE, E27	673
SQUARE TURN WL, G9	781
SQUARE WL, E27	779
SUN / BIG SUN PD, E27	315
SYNA GARDEN SP	689
SYNA PLANT SP	689
SYNA SP	689
SYROS LV, QR-C51	489

T	
TAHA LIGHT SET, BATTERY-POWERED	441, 601
TELESKOP LV, QR-C51	486
TENORA CL, E27	268
TENSEO LOW-VOLTAGE CABLE	482-484
TENSEO LOW-VOLTAGE CABLE	
ACCESSORIES	485
TERANG 200 CW	817
THEO BRACKET CW	808
THEO BRACKET SP	701
THEO PATHLIGHT POLE, DOUBLE	652
THEO UP/DOWN WL, QPAR51	377, 735
THEO WL, QPAR51	736
TINY SUN TL	443
TODAY PRO DISPLAY	783
TONGA® 1-PHASE, PD, E14	511
TONGA® PD, E14	307
TONILA TL	453, 601
TRAIL-LITE® 60 EL	848
TRUKKO 60 WL	332
TRUKKO 90 WL	332
TRUST 30 POLE	667
TRUST 60 POLE	667
TS V 3-PHASE	543

U	
UNIVERSAL DOWNLIGHT DL	
WITH COVER, MULTIPACK	208, 209
UNIVERSAL DOWNLIGHT DL,	
MOVE, PHASE	207
UNIVERSAL DOWNLIGHT DL, PHASE	205

V	
VANO WING SP, DALI	719
VAP SLIM 30 POLE, E27	671
VAP SLIM 60 POLE, E27	671
VAP SLIM 90 POLE, E27	671
VARU EL, QPAR51	234
VARYT CL, E14	251
VARYT TL, E14	443
VARYT WL, E14	327
VILUA L WL	763
VILUA S WL	763
VILUA UP/DOWN, WL	763
VINOLINA ONE TL, BATTERY	437, 597
VINOLINA TL, BATTERY	437, 597
VINOLINA TWO TL, BATTERY	439, 599

W	
WALLYX WL, QPAR51	768
WL 106 E14	335
WL 149 WL, PHASE	334
WL 149 WL, QT-DE12	334
WORKLIGHT FL	445
WORKLIGHT PD, DALI	288
WORKLIGHT PRO 120 PD, DALI	287
WORKLIGHT PRO 150 PD, DALI	287
WORKLIGHT PRO FL, DOUBLE	444
WORKLIGHT PRO FL, SINGLE	444
WORKLIGHT TL	445
WORO EL	243

SYMBOLS KEY



Recommendations

Displays accessories and recommended lamps for the chosen product



Power cable length in cm
Supply cable length in cm (with open cable end)

MIX
match

Mix & Match

Indicates products that can be combined



Shape of the installation opening



Energy efficiency class

„This light is suitable for bulbs with an energy class rating of ...“



Specification of the installation depth



Dimmable with:

- **C** = Trailing-edge phase dimmer
- **L** = Leading-edge phase dimmer
- **Uni** = Universal dimmer
- **1-10 V**
- **Dali** = DALI bus system
- **Switch** = Switch/button or touch control on the light



Product's capacity to be driven over specified



The weight capacity of the product up to specified value in tonnes. Measurements based on concrete installation.



Allows the installation of electrical control equipment on materials whose flammability is not known.



Protection classes

- Protection class I / Protective conductor
- Protection class II / Protection by double or reinforced insulation
- Protection category III / Protection through low voltage



Through-wiring possible



IP protection type:

Indicates the suitability of electrical equipment for different environmental conditions.



Independent converter:
Control equipment also for use outside of lights



IK impact resistance rating

The IK impact resistance rating is a measure of the resistance of housings for electrical equipment to mechanical stress, especially impact stress.



Short-circuit protected safety control equipment



For indoor use only Not suitable for indoor use



Half-diffusion angle:

Describes the beam angle in degrees. The smaller the angle, the more concentrated the light will be.



Connected lighting:
Indicates smart products that use the following protocols:
· Zigbee®
· DALI
· Bluetooth



Rotation and pivoting capacity in degrees:

- Rotation range
- Pivot range
- Gimballed



CCT switch:

By means of an integrated CCT switch, the light colour can be changed from 2700 K, 3000 K, 4000 K to 6500 K during installation.



Unified Glare Rating:

The lower the UGR value, the lower the psychological glare.



Indicates lights with RGB+W and RGB (red-green-blue + white and red-green-blue)



Preservation of luminous flux:

Describes the amount by which the luminous flux of an LED decreases during a specified period.



Dim-to-Warm:

With dimmers, the light colour can be altered from cold white to warm white.



Pendant cable length in cm



- Products with integrated LEDs
- Products with lamp socket

Many of the products shown in this catalogue are protected by trademarks, registered designs, utility models or patents. Any violation of these property rights or the use of text and layout design or copyrighted images without our authorisation will be prosecuted. The illustrations and information contained in this catalogue are for illustrative purposes only and are not legally binding in terms of colour, shape, design or technical details. Product descriptions and specifications are subject to correction and amendment.

All products in our range are subject to our strict quality assurance procedures and comply with generally applicable standards. This catalogue contains a general range and is not country-specific. Any deviations from country-specific guidelines must be clarified before ordering. SLV cannot be held responsible for any deviations in terms of technical standards. All weights and dimensions are given in kg and cm respectively unless stated otherwise. We reserve the right to make technical changes!

The presentation of our lights with realistic photos showing them in use is possible thanks to the kind cooperation and agreement of the owners or designers of the environments depicted in the images. We would like to take this opportunity to thank all those who consented to having photos taken and used.

The publication of this catalogue invalidates the prices specified in previous lists and catalogues. SLV is entitled to adjust the respective price list to changing market conditions, in the event of significant changes in procurement costs, changes in value added tax or procurement prices.

All prices are recommended retail prices (RRP) and indicated in Euro without VAT.

Publisher
SLV GmbH, Germany
Daimlerstraße 21-23
52531 Übach-Palenberg
T +49 (0) 2451 4833-0
slv.com

Copyright
© SLV GmbH, 2023



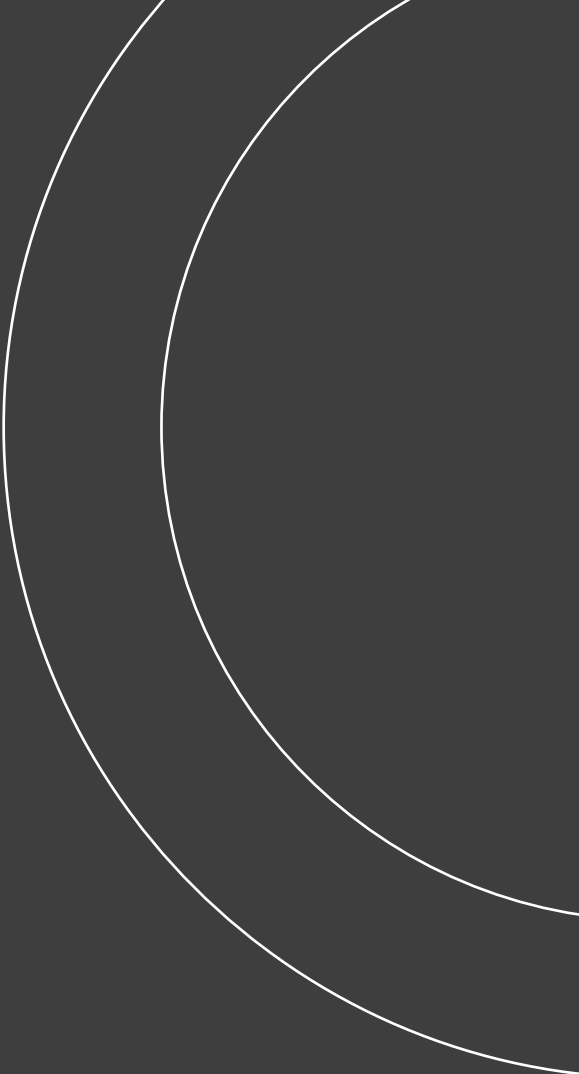

SLV GmbH | Daimlerstraße 21-23, 52531 Uebach-Palenberg, Germany, +49 (0) 2451 4833-333, info@slv.de
SLV Austria | +49 (2451) 4833 355, export@slv.de
SLV Belgium | Herentalsebaan 429, B-2160 Wommelgem, +32 (0) 3/385 30 08, info@slv.be
SLV Nordics | Flade Engvej 4, 9900 Frederikshavn, Denmark, +45 9310 7474, info@nordics.slv.com
SLV France | Zac du Martelet, 88, rue Henri Dépaigneux, F-69400 Limas, +33 4 74 02 71 20, infofr@slv.com
SLV LIGHTING UK LTD | Unit E Chiltern Park, Boscombe Road, Dunstable, LU5 5LT, +44 (0)203 968 11 00, sales@uk.slv.com
SLV Italia S.r.l. | Via Lecco, 19/D, 23896 Bevera di Sirtori (LC), +39 039 5983575, infoit@slv.com
SLV Nederland | Kazernestraat 19, 5928 NL Venlo, +31 773204343, info@slv.nl
SLV i Norge, del av SLV Nordics | Tors veg 9B, 7035 Trondheim, +47 4777 1080, post-no@slv.com
SLV Poland | +48 (22) 7224975, slv@slv.pl
SLV Portugal | R. Margarida de Abreu, no13 – Lj2, 1900-314 Lisboa, +351 210 185 961, info@pt.slv.com
SLV Swiss SA | Route du Bey 6 Box 1-4, Z.I. La Jonnaire, CH-1847 Rennaz, +41 218113232, info@slv-swiss.ch
SLV d.o.o | Barjanska cesta 50, SI-1000 Ljubljana, +386 1 2009 730, info@slv.si
SLV Spain | Antic Cami Real Valencia, 38, L17, 08860 Castelldefels, Barcelona, 931 168 161, info@slv.es
SLV Czech s.r.o. | V Sedlci 28/17, CZ-160 00 Praha 6, +420 739 282 151, info@cz.slv.com